

# RFP45N03L, RF1S45N03L, RF1S45N03LSM

45A, 30V, 0.022 Ohm,  
Logic Level, N-Channel Power MOSFETs

September 1998

## Features

- 45A, 30V
- $r_{DS(ON)} = 0.022\Omega$
- *Temperature Compensating* PSPICE Model
- Can be Driven Directly from CMOS, NMOS, and TTL Circuits
- Peak Current vs Pulse Width Curve
- UIS Rating Curve
- 175°C Operating Temperature
- Related Literature
  - TB334 "Guidelines for Soldering Surface Mount Components to PC Boards"

## Ordering Information

PART NUMBER	PACKAGE	BRAND
RFP45N03L	TO-220AB	FP45N03L
RF1S45N03L	TO-262AA	F45N03L
RF1S45N03LSM	TO-263AB	F45N03L

NOTE: When ordering, use the entire part number. Add the suffix 9A, to obtain the TO-263AB variant in tape and reel, e.g., RF1S45N03LSM9A.

## Description

These are N-Channel power MOSFETs manufactured using the MegaFET process. This process, which uses feature sizes approaching those of LSI circuits, gives optimum utilization of silicon, resulting in outstanding performance. They were designed for use in applications such as switching regulators, switching converters, motor drivers and relay drivers. These transistors can be operated directly from integrated circuits.

Formerly developmental type TA49030.

## Symbol

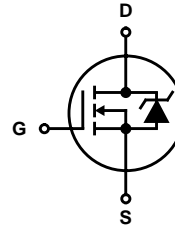

## Packaging

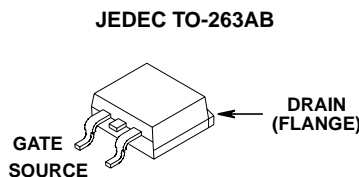
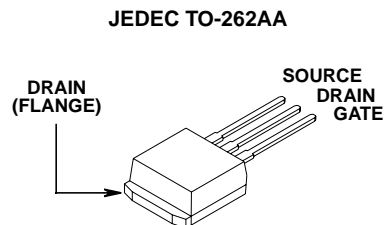
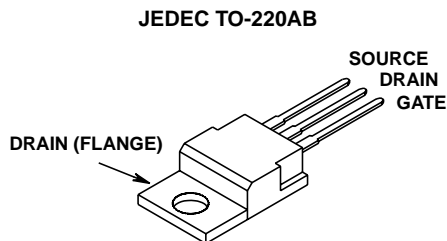

## RFP45N03L, RF1S45N03L, RF1S45N03LSM

### Absolute Maximum Ratings $T_C = 25^\circ\text{C}$ , Unless Otherwise Specified

	RFP45N03L, RF1S45N03L, RF1S45N03LSM	UNITS
Drain to Source Voltage (Note 1) . . . . .	$V_{DSS}$	30 V
Drain to Gate Voltage $R_{GS} = 20\text{k}\Omega$ (Note 1) . . . . .	$V_{DGR}$	30 V
Gate to Source Voltage . . . . .	$V_{GS}$	$\pm 10$ V
Continuous Drain Current . . . . .	$I_D$	45 A
Pulsed Drain Current (Note 3) . . . . .	$I_{DM}$	Refer to Peak Current Curve
Pulsed Avalanche Rating . . . . .	$E_{AS}$	Refer to UIS Curve
Power Dissipation . . . . .	$P_D$	90 W
Derate Above $25^\circ\text{C}$ . . . . .		0.606 $\text{W}/^\circ\text{C}$
Operating and Storage Temperature . . . . .	$T_J, T_{STG}$	-55 to 175 $^\circ\text{C}$
Maximum Temperature for Soldering		
Leads at 0.063in (1.6mm) from Case for 10s . . . . .	$T_L$	300 $^\circ\text{C}$
Package Body for 10s, See Techbrief 334 . . . . .	$T_{pkg}$	260 $^\circ\text{C}$

*CAUTION: Stresses above those listed in "Absolute Maximum Ratings" may cause permanent damage to the device. This is a stress only rating and operation of the device at these or any other conditions above those indicated in the operational sections of this specification is not implied.*

**NOTE:**

1.  $T_J = 25^\circ\text{C}$  to  $150^\circ\text{C}$ .

### Electrical Specifications $T_C = 25^\circ\text{C}$ , Unless Otherwise Specified

PARAMETER	SYMBOL	TEST CONDITIONS	MIN	TYP	MAX	UNITS	
Drain to Source Breakdown Voltage	$BV_{DSS}$	$I_D = 250\mu\text{A}, V_{GS} = 0\text{V}$	30	-	-	V	
Gate to Threshold Voltage	$V_{GS(TH)}$	$V_{GS} = V_{DS}, I_D = 250\mu\text{A}$	1	-	2	V	
Zero Gate Voltage Drain Current	$I_{DSS}$	$V_{DS} = \text{Rated } BV_{DSS}, V_{GS} = 0\text{V}$	-	-	25	$\mu\text{A}$	
		$V_{DS} = \text{Rated } BV_{DSS}, V_{GS} = 0\text{V}, T_C = 150^\circ\text{C}$	-	-	250	$\mu\text{A}$	
Gate to Source Leakage Current	$I_{GSS}$	$V_{GS} = \pm 10\text{V}$	-	-	$\pm 100$	nA	
Drain to Source On Resistance (Note 2)	$r_{DS(ON)}$	$I_D = 45\text{A}, V_{GS} = 5\text{V}$ (Figure 11)	-	-	0.022	$\Omega$	
Turn-On Time	$t_{ON}$	$V_{DD} = 15\text{V}, I_D = 45\text{A}, R_L = 0.33\Omega,$ $V_{GS} = 5\text{V}, R_{GS} = 5\Omega$ (Figures 15, 18, 19)	-	-	260	ns	
Turn-On Delay Time	$t_{d(ON)}$		-	15	-	ns	
Rise Time	$t_r$		-	160	-	ns	
Turn-Off Delay Time	$t_{d(OFF)}$		-	20	-	ns	
Fall Time	$t_f$		-	20	-	ns	
Turn-Off Time	$t_{OFF}$		-	-	60	ns	
Total Gate Charge	$Q_g(\text{TOT})$	$V_{GS} = 0\text{V to } 10\text{V}$	$V_{DD} = 24\text{V}, I_D = 45\text{A},$ $R_L = 0.533\Omega$ $I_G(\text{REF}) = 0.6\text{mA}$ (Figures 20, 21)	-	50	60	nC
Gate Charge at 5V	$Q_g(5)$	$V_{GS} = 0\text{V to } 5\text{V}$		-	30	36	nC
Threshold Gate Charge	$Q_g(\text{TH})$	$V_{GS} = 0\text{V to } 1\text{V}$		-	1.5	1.8	nC
Input Capacitance	$C_{ISS}$	$V_{DS} = 25\text{V}, V_{GS} = 0\text{V}, f = 1\text{MHz}$ (Figure 14)	-	1650	-	pF	
Output Capacitance	$C_{OSS}$		-	575	-	pF	
Reverse Transfer Capacitance	$C_{RSS}$		-	200	-	pF	
Thermal Resistance Junction-to-Case	$R_{\theta JC}$		-	-	1.65	$^\circ\text{C}/\text{W}$	
Thermal Resistance Junction-to-Ambient	$R_{\theta JA}$		-	-	80	$^\circ\text{C}/\text{W}$	

### Source to Drain Diode Specifications

PARAMETER	SYMBOL	TEST CONDITIONS	MIN	TYP	MAX	UNITS
Source to Drain Diode Voltage	$V_{SD}$	$I_{SD} = 45\text{A}$	-	-	1.5	V
Diode Reverse Recovery Time	$t_{rr}$	$I_{SD} = 45\text{A}, dI_{SD}/dt = 100\text{A}/\mu\text{s}$	-	-	125	ns

**NOTES:**

2. Pulse test: pulse width  $\leq 300\mu\text{s}$ , duty cycle  $\leq 2\%$ .
3. Repetitive rating: pulse width limited by Max junction temperature. See Transient Thermal Impedance curve (Figure 3).

Typical Performance Curves Unless Otherwise Specified

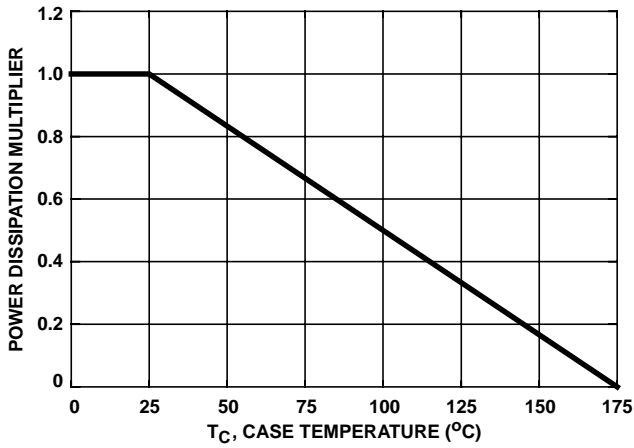

FIGURE 1. NORMALIZED POWER DISSIPATION vs CASE TEMPERATURE

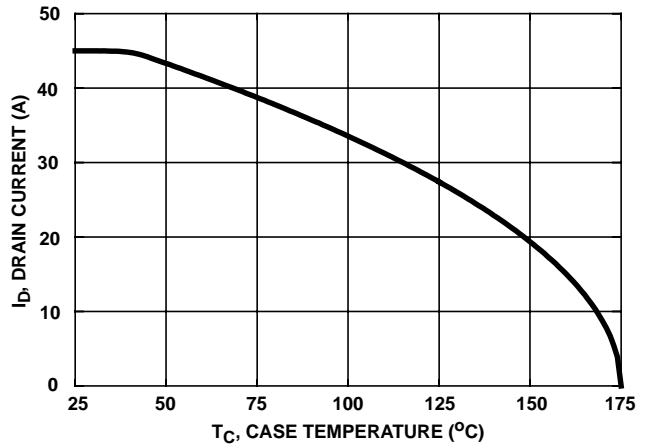

FIGURE 2. MAXIMUM CONTINUOUS DRAIN CURRENT vs CASE TEMPERATURE

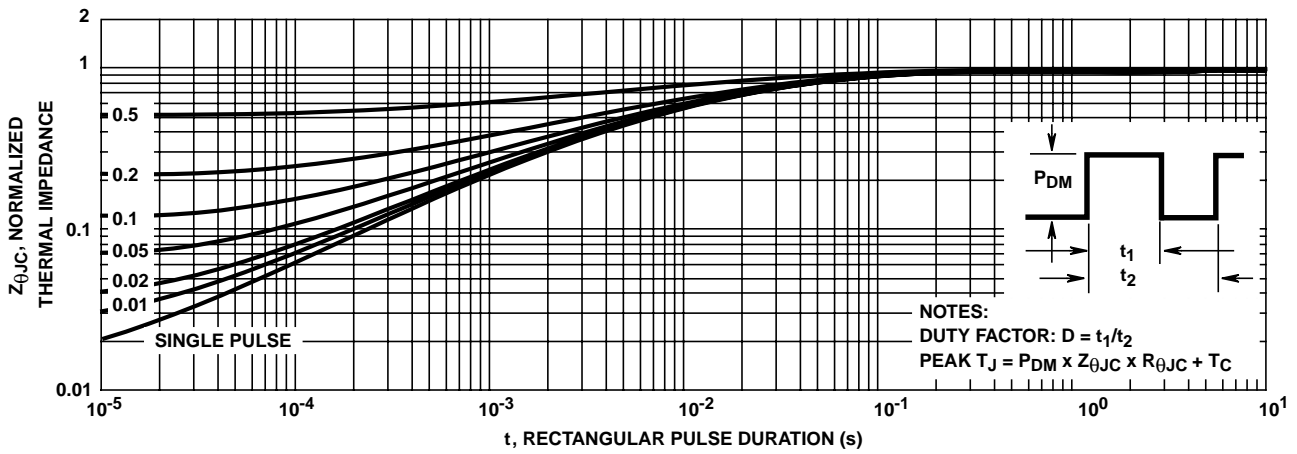

FIGURE 3. NORMALIZED MAXIMUM TRANSIENT THERMAL IMPEDANCE

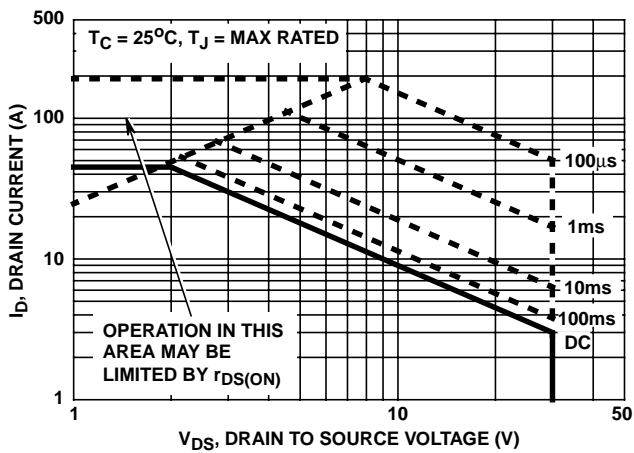

FIGURE 4. FORWARD BIAS SAFE OPERATING AREA

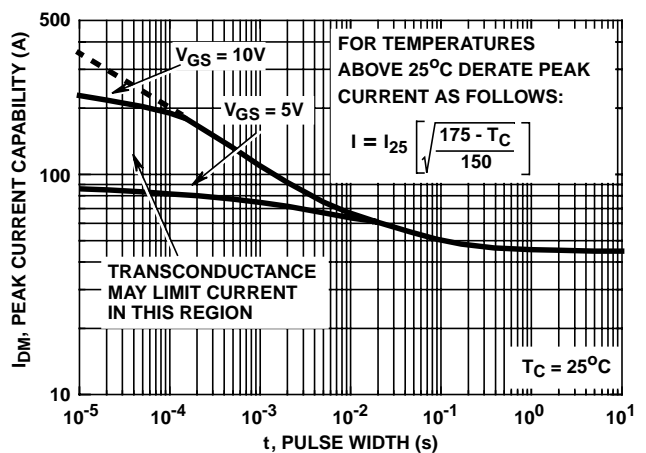
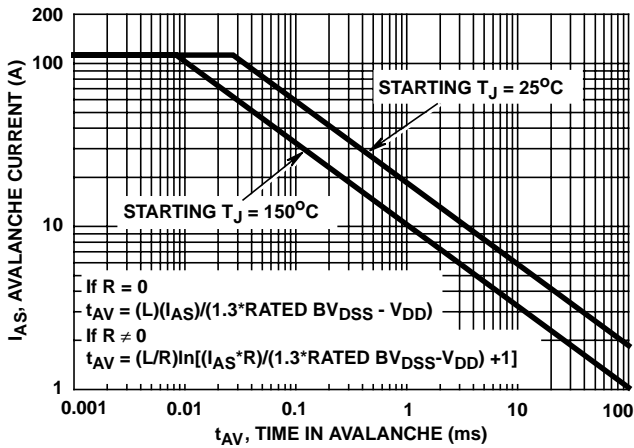

FIGURE 5. PEAK CURRENT CAPABILITY

Typical Performance Curves Unless Otherwise Specified (Continued)



NOTE: Refer to Harris Application Notes AN9321 and AN9322.

FIGURE 6. UNCLAMPED INDUCTIVE SWITCHING

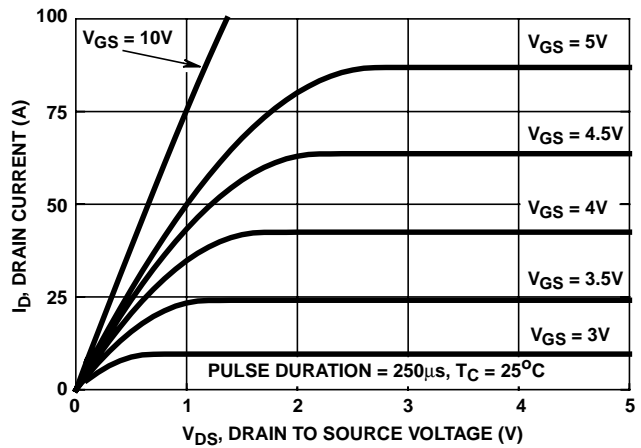

FIGURE 7. SATURATION CHARACTERISTICS

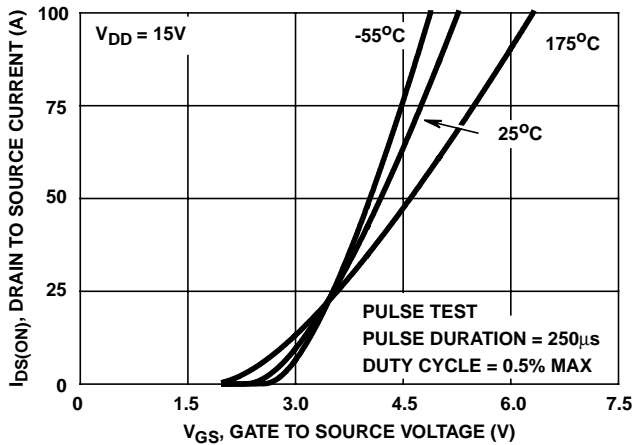

FIGURE 8. TRANSFER CHARACTERISTICS

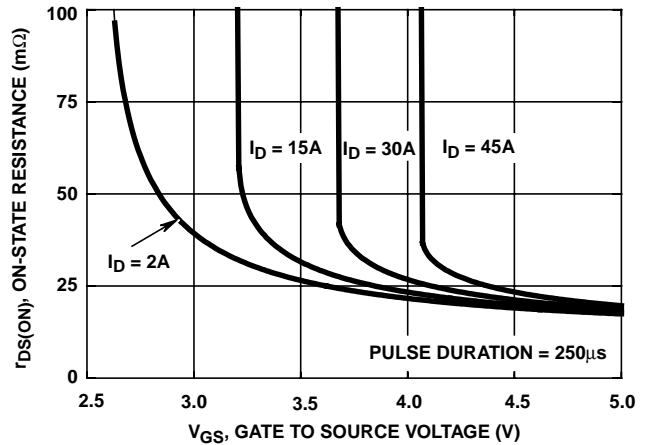

FIGURE 9. DRAIN TO SOURCE ON RESISTANCE vs GATE VOLTAGE AND DRAIN CURRENT

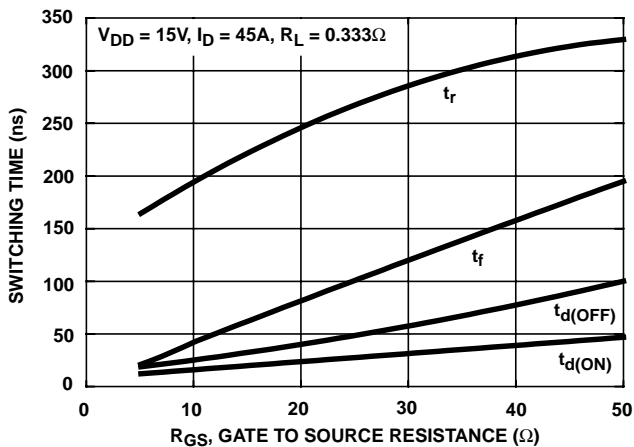

FIGURE 10. SWITCHING TIME vs GATE RESISTANCE

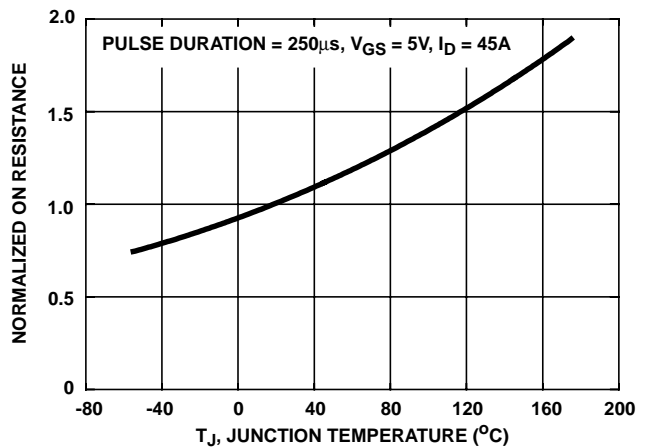

FIGURE 11. NORMALIZED DRAIN TO SOURCE ON RESISTANCE vs JUNCTION TEMPERATURE

Typical Performance Curves Unless Otherwise Specified (Continued)

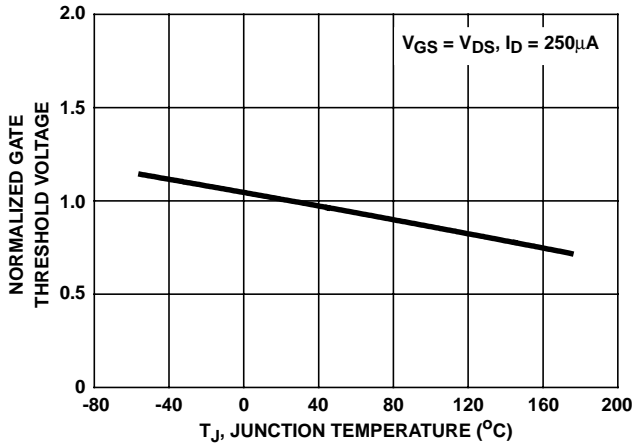

FIGURE 12. NORMALIZED GATE THRESHOLD VOLTAGE vs JUNCTION TEMPERATURE

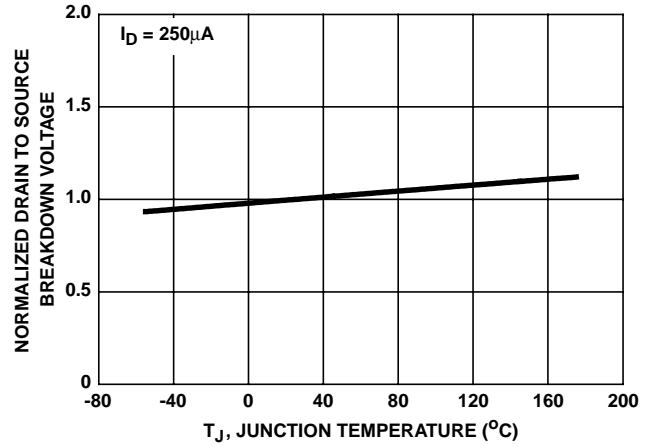

FIGURE 13. NORMALIZED DRAIN TO SOURCE BREAKDOWN VOLTAGE vs JUNCTION TEMPERATURE

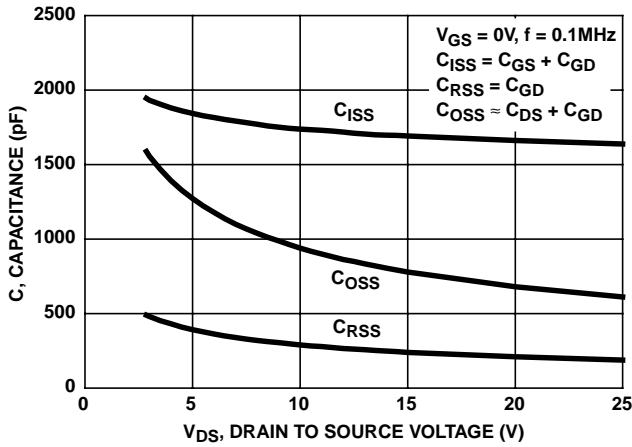
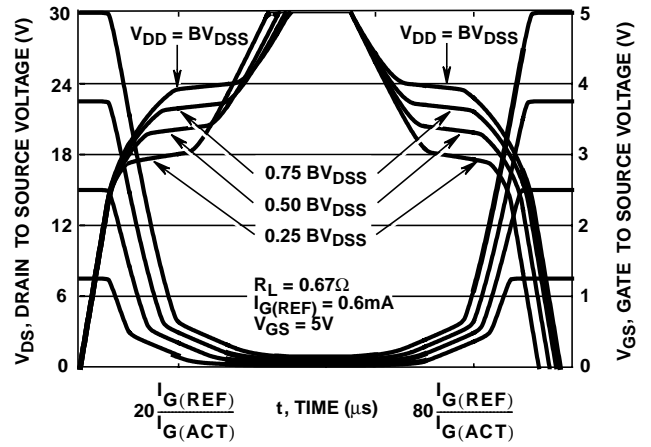

FIGURE 14. CAPACITANCE vs DRAIN TO SOURCE VOLTAGE



NOTE: Refer to Harris Application Notes AN7254 and AN7260.

FIGURE 15. NORMALIZED SWITCHING WAVEFORMS FOR CONSTANT GATE CURRENT

Test Circuits and Waveforms

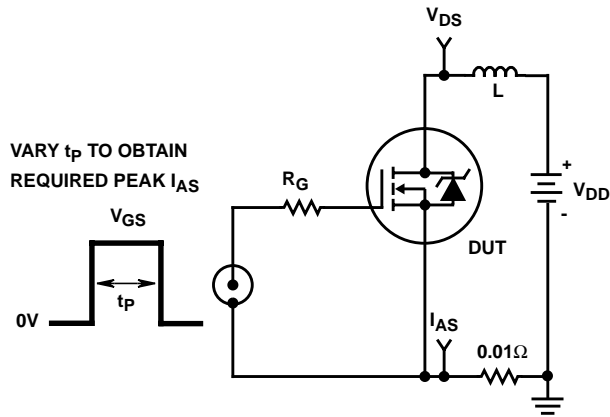

FIGURE 16. UNCLAMPED ENERGY TEST CIRCUIT

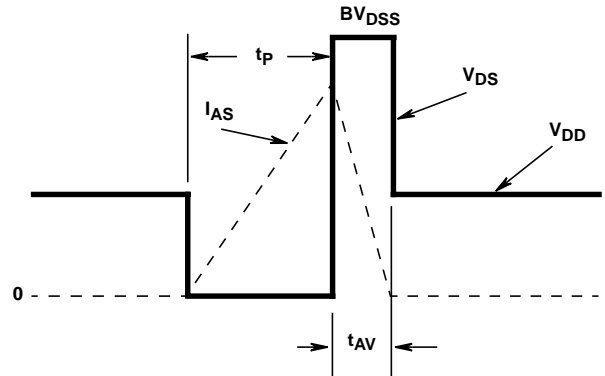

FIGURE 17. UNCLAMPED ENERGY WAVEFORMS

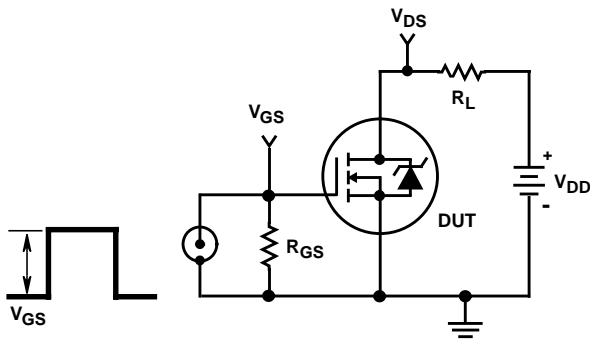

FIGURE 18. SWITCHING TIME TEST CIRCUIT

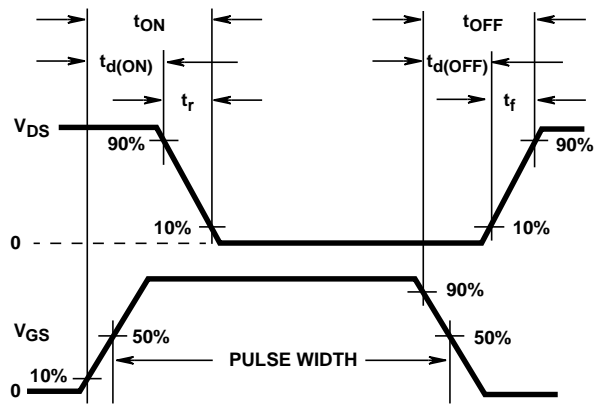

FIGURE 19. RESISTIVE SWITCHING WAVEFORMS

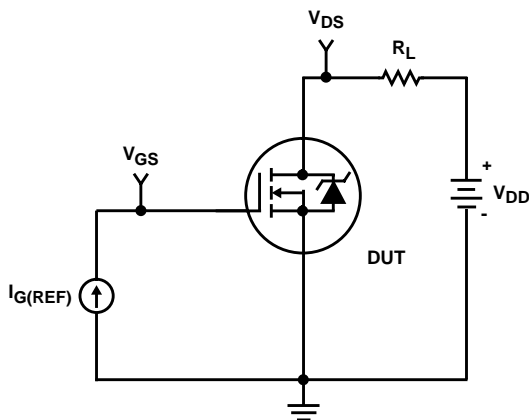

FIGURE 20. GATE CHARGE TEST CIRCUIT

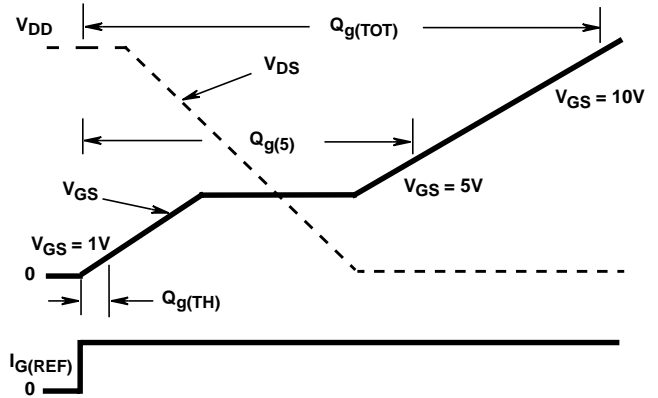

FIGURE 21. GATE CHARGE WAVEFORMS

## RFP45N03L, RF1S45N03L, RF1S45N03LSM

### PSPICE Electrical Model

.SUBCKT RFP45N03L 2 1 3; rev 11/22/94

CA 12 8 2.55e-9  
 CB 15 14 2.64e-9  
 CIN 6 8 1.45e-9

DBODY 7 5 DBDMOD  
 DBREAK 5 11 DBKMOD  
 DPLCAP 10 5 DPLCAPMOD

EBREAK 11 7 17 18 33.3  
 EDS 14 8 5 8 1  
 EGS 13 8 6 8 1  
 ESG 6 10 6 8 1  
 EVTO 20 6 18 8 1

IT 8 17 1

LDRAIN 2 5 1e-9  
 LGATE 1 9 4.9e-9  
 LSOURCE 3 7 4.9e-9

MOS1 16 6 8 8 MOSMOD M = 0.99  
 MOS2 16 21 8 8 MOSMOD M = 0.01

RBREAK 17 18 RBKMOD 1  
 RDRAIN 50 16 RDSMOD 0.14e-3  
 RGATE 9 20 0.89  
 RIN 6 8 1e9  
 RSCL1 5 51 RSCLMOD 1e-6  
 RSCL2 5 50 1e3  
 RSOURCE 8 7 RDSMOD 10.31e-3  
 RVTO 18 19 RVTOMOD 1

S1A 6 12 13 8 S1AMOD  
 S1B 13 12 13 8 S1BMOD  
 S2A 6 15 14 13 S2AMOD  
 S2B 13 15 14 13 S2BMOD

VBAT 8 19 DC 1  
 VTO 21 6 0.583

ESCL 51 50 VALUE = {(V(5,51)/ABS(V(5,51)))\*(PWR(V(5,51)\*1e6/176,6))}

.MODEL DBDMOD D (IS = 3.61e-13 RS = 5.06e-3 TRS1 = 3.05e-3 TRS2 = 7.57e-6 CJO = 2.16e-9 TT = 2.18e-8)  
 .MODEL DBKMOD D (RS = 1.66e-1 TRS1 = -2.97e-3 TRS2 = 7.57e-6)  
 .MODEL DPLCAPMOD D (CJO = 0.96e-9 IS = 1e-30 N = 10)  
 .MODEL MOSMOD NMOS (VTO = 2.313 KP = 53.82 IS = 1e-30 N = 10 TOX = 1 L = 1u W = 1u)  
 .MODEL RBKMOD RES (TC1 = 8.95e-4 TC2 = -1e-7)  
 .MODEL RDSMOD RES (TC1 = 3.82e-3 TC2 = 1.17e-5)  
 .MODEL RSCLMOD RES (TC1 = 2.03e-3 TC2 = 0.45e-5)  
 .MODEL RVTOMOD RES (TC1 = -2.27e-3 TC2 = -5.75e-7)  
 .MODEL S1AMOD VSWITCH (RON = 1e-5 ROFF = 0.1 VON = -4.82 VOFF = -2.82)  
 .MODEL S1BMOD VSWITCH (RON = 1e-5 ROFF = 0.1 VON = -2.82 VOFF = -4.82)  
 .MODEL S2AMOD VSWITCH (RON = 1e-5 ROFF = 0.1 VON = -2.67 VOFF = 2.33)  
 .MODEL S2BMOD VSWITCH (RON = 1e-5 ROFF = 0.1 VON = 2.33 VOFF = -2.67)

.ENDS

NOTE: For further discussion of the PSPICE model, consult **A New PSPICE Sub-Circuit for the Power MOSFET Featuring Global Temperature Options**; written by William J. Hepp and C. Frank Wheatley.

