

600mA Low Noise High PSRR LDO with Shutdown

Description

The FP6166 is a low dropout, low noise, high PSRR and very low quiescent current positive linear regulator. The FP6166 can supply 600mA output current with low dropout voltage at about 890mV that optimized for battery-powered systems or portable wireless devices such as mobile phones. The shutdown function can provide remote control for the external signal to decide the on/off state of FP6166 that consumes less than 0.1µA during shutdown mode.

The FP6166 regulator is able to operate with output capacitors as small as 1µF for stability. Other than the current limit protection, FP6166 also offers the on chip thermal shutdown feature providing protection against overload or any condition when the ambient temperature exceeds the maximum junction temperature.

The FP6166 offers high precision output voltage of ±2%. It is housed in low-profile, space-saving SOT-23-5 and SOP-8 packages.

Pin Assignments

S5 Package (SOT-23-5)

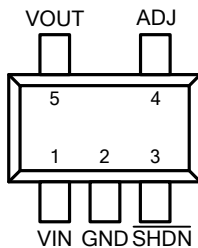

S0 Package (SOP-8)

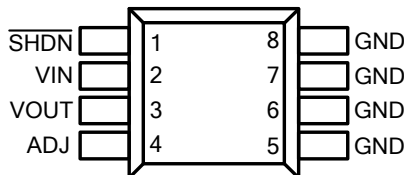

Features

- Low Dropout Voltage of 890mV at 600mA
- Low 30µVrms Output Noise
- Guaranteed 600mA Output Current
- Adjustable Mode Output Voltage Range is from 1V to 5.5V- V_{drop}
- High Power Supply Rejection Ratio of 70dB at 10kHz
- Very Low Quiescent Current at 45µA
- Max. ±2% Output Voltage Accuracy
- Fast Response in Line/Load Transient
- Thermal Shutdown Protection
- Current Limit Protection
- Low-ESR Ceramic Capacitor for Output Stability
- Miniature Packages: SOT-23-5 and SOP-8
- RoHS Compliant

Applications

- Mobile Phone
- Notebook, Sub-Notebook and Tablet Computer
- DSC
- Portable Information Appliance
- Battery Power System

Ordering Information

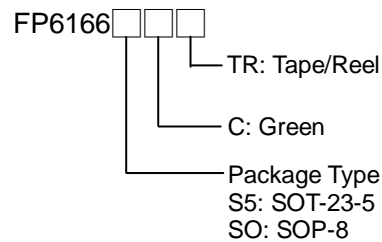

SOT-23-5 Marking

Part Number	Product Code
FP6166S5CTR	C7G

Figure 1. Pin Assignment of FP6166

Typical Application Circuit

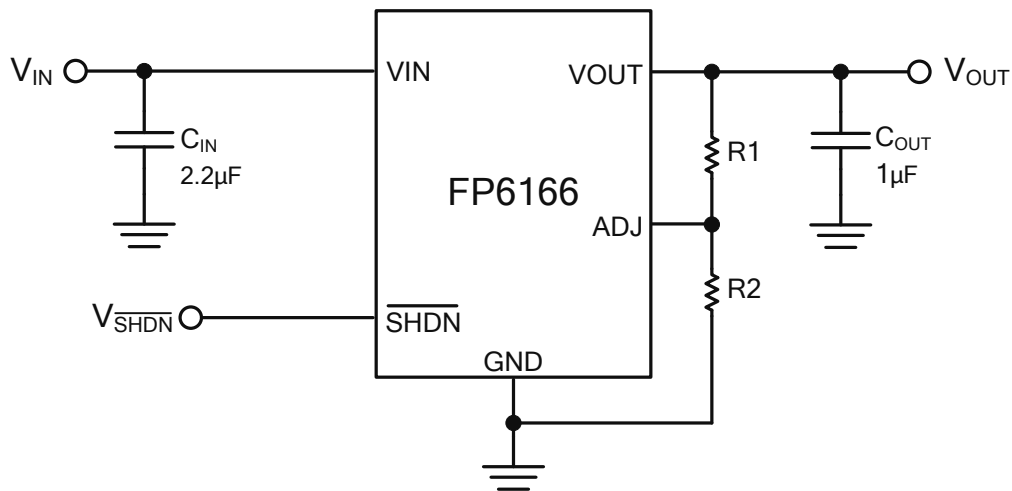

Figure 2. Typical Application Circuit of FP6166

Note 1 : To prevent oscillation, it is recommended to use minimum 2.2µF/1µF X7R or X5R dielectric capacitors if ceramics are used as input/output capacitors.

Functional Pin Description

Pin Name	Pin Function
VIN	Power is supplied to this device from this pin which is required an input filter capacitor. In general, the input capacitor in the range of 2.2µF to 10µF is sufficient.
VOUT	The output supplies power to loads. The output capacitor is required to prevent output voltage from oscillation. The FP6166 is stable with a 1µF or greater output capacitor. The larger output capacitor will be required for application with larger load transients. The large output capacitor could reduce output noise, improve stability and PSRR.
ADJ	Voltage Feedback Input Pin. Connect ADJ and VOUT with a resistive voltage divider.
GND	Common Ground Pin
SHDN	Pull this pin high to enable IC, and pull this pin low to shutdown IC. Keeping this pin floating will shut down IC due to the built-in pull-low resistor.

Block Diagram

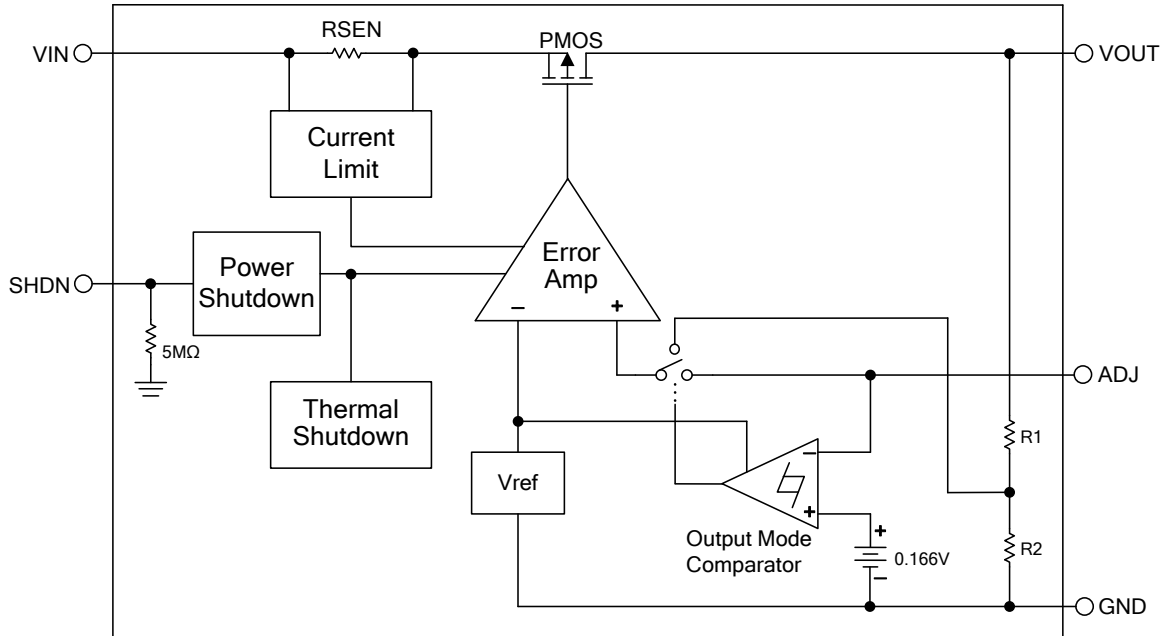

Figure 3. Block Diagram of FP6166

Absolute Maximum Ratings

- V_{IN} , \overline{SHDN} , ADJ to GND ----- +6V
- Package Thermal Resistance (θ_{JA})
 - SOT-23-5 ----- +250°C/W
 - SOP-8 ----- +110°C/W
- Maximum Junction Temperature (T_J) ----- +150°C
- Storage Temperature Range (T_{STG}) ----- -65°C to +150°C
- Lead Temperature (Soldering, 10 sec.) (T_{LEAD}) ----- +260°C

Note 2 : Stresses beyond those listed under "Absolute Maximum Ratings" may cause permanent damage to the device.

Recommended Operating Conditions

- Input Voltage (V_{IN}) ----- +2.0V to +5.5V
- Operating Temperature Range (T_{OPR}) ----- -40°C to +85°C

Electrical Characteristics

($V_{IN}=V_{OUT}+1V$, \overline{SHDN} pin connected to V_{IN} , $C_{IN}=2.2\mu F$, $C_{OUT}=1\mu F$, $T_A=25^\circ C$, unless otherwise specified)

Parameter	Symbol	Conditions	Min	Typ	Max	Unit	
Current Limit	I_{LIMIT}	$R_{Load}=1\Omega$	600	800		mA	
Short Circuit Current	I_{SHORT}			500		mA	
Quiescent Current	I_Q	$I_{OUT}=0mA$		45	70	μA	
Standby Current	I_{STBY}	\overline{SHDN} pin connected to GND		0.1	1	μA	
Reference Voltage	V_{REF}	$I_{OUT}=1mA$		1		V	
Reference Voltage Accuracy	ΔV_{REF}	$I_{OUT}=1mA$	-2		+2	%	
Dropout Voltage (Note3)	V_{DROP}	$I_{OUT}=150mA$	$V_{OUT}=1.2V$		1050	1260	mV
			$V_{OUT}=1.8V$		750	900	
			$V_{OUT}=2.5V$		500	600	
			$V_{OUT}=3.0V$		270	330	
			$V_{OUT}=3.3V$		230	270	
		$I_{OUT}=300mA$	$V_{OUT}=1.2V$		1730	2075	
			$V_{OUT}=1.8V$		1450	1750	
			$V_{OUT}=2.5V$		980	1170	
			$V_{OUT}=3.0V$		510	610	
			$V_{OUT}=3.3V$		400	480	
		$I_{OUT}=600mA$	$V_{OUT}=1.2V$		1995	2395	
			$V_{OUT}=1.8V$		1600	1920	
			$V_{OUT}=2.5V$		1350	1620	
			$V_{OUT}=3.0V$		1150	1380	
			$V_{OUT}=3.3V$		890	1070	
Line Regulation	ΔV_{LINE}	$I_{OUT}=1mA$, $V_{IN}=V_{OUT}+1V$ to 5V		1	8	mV	
Load Regulation (Note4)	ΔV_{LOAD}	$I_{OUT}=0mA$ to 150mA		6	30	mV	
Ripple Rejection (Note5)	PSRR	$V_{IN}=V_{OUT}+1V$, $f_{RIPPLE}=10kHz$		70		dB	
Output Noise Voltage (Note5)	V_{NOISE}	$C_{OUT}=1\mu F$, $I_{OUT}=0mA$		30		μV_{RMS}	
Temperature Coefficient (Note5)	TC	$I_{OUT}=1mA$, $V_{IN}=5V$		100		ppm/ $^\circ C$	
Thermal Shutdown Threshold (Note5)	T_{SD}			150		$^\circ C$	
	ΔT_{SD}	Hysteresis		25		$^\circ C$	

Electrical Characteristics (Continued)

($V_{IN}=V_{OUT}+1V$, \overline{SHDN} pin connected to V_{IN} , $C_{IN}=2.2\mu F$, $C_{OUT}=1\mu F$, $T_A=25^\circ C$, unless otherwise specified)

Parameter	Symbol	Conditions	Min	Typ	Max	Unit
\overline{SHDN} Pull-Low Resistance	$R_{\overline{SHDN}}$			5		M Ω
\overline{SHDN} Pin Threshold	$V_{\overline{SHDN} (ON)}$	Start-up	1.0			V
	$V_{\overline{SHDN} (OFF)}$	Shutdown			0.4	V

Note 3 : The dropout voltage is defined as $V_{IN}-V_{OUT}$, which is measured when V_{OUT} drops 2% of its normal value with the specified output current.

Note 4 : Load regulation and dropout voltage are measured at a constant junction temperature by using a 40ms low duty cycle current pulse.

Note 5 : Guarantee by design.

Typical Performance Curves

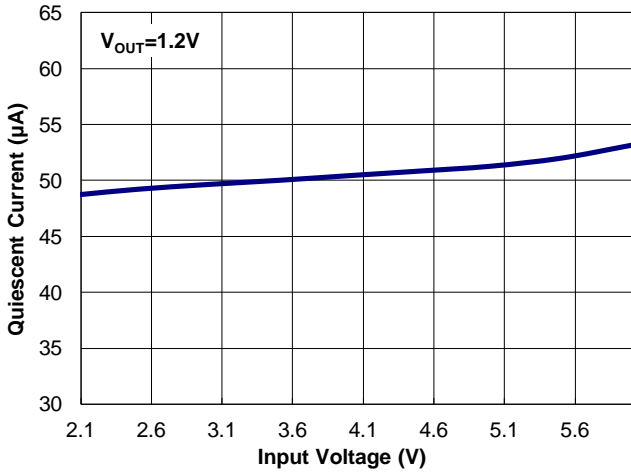

Figure 4. Quiescent Current vs. Input Voltage

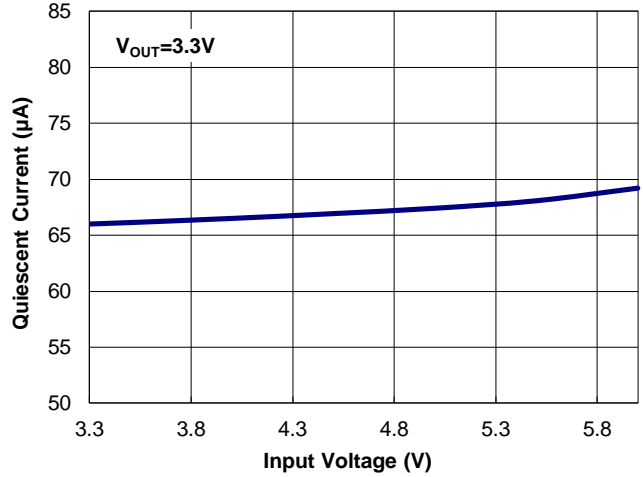

Figure 5. Quiescent Current vs. Input Voltage

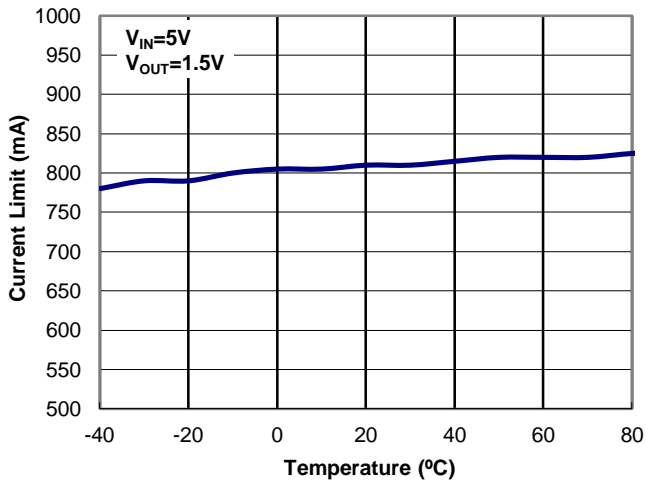

Figure 6. Current Limit vs. Temperature

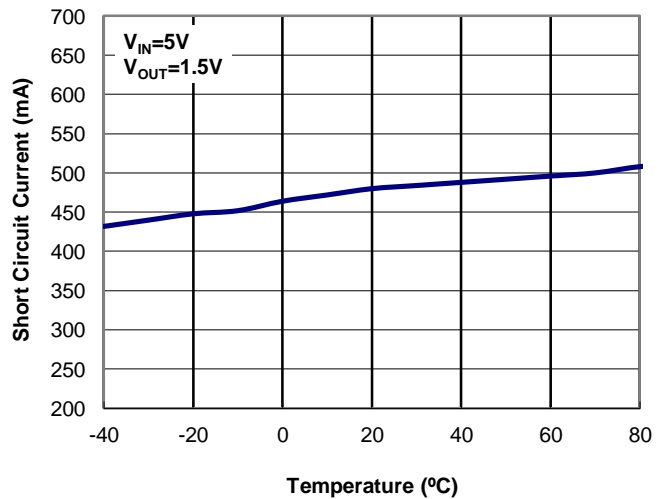

Figure 7. Short Circuit Current vs. Temperature

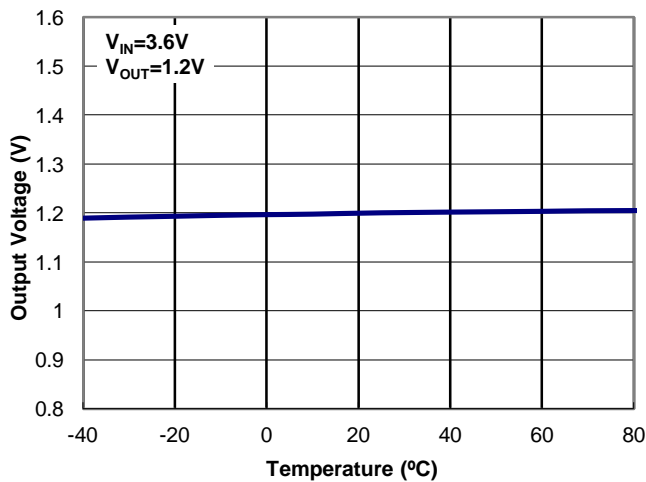

Figure 8. Output Voltage vs. Temperature

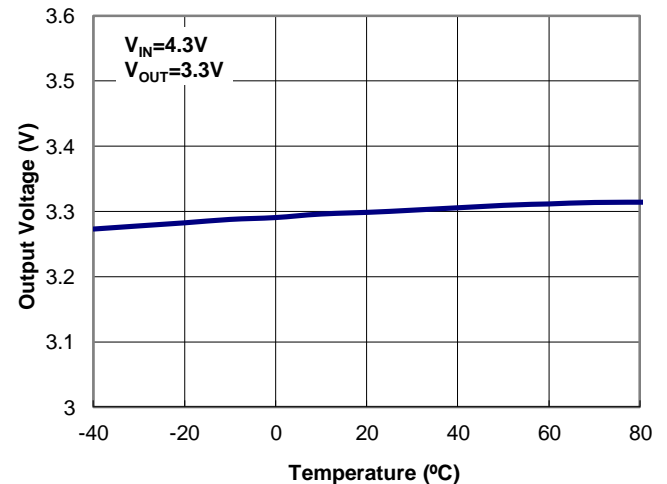

Figure 9. Output Voltage vs. Temperature

Typical Performance Curves (Continued)

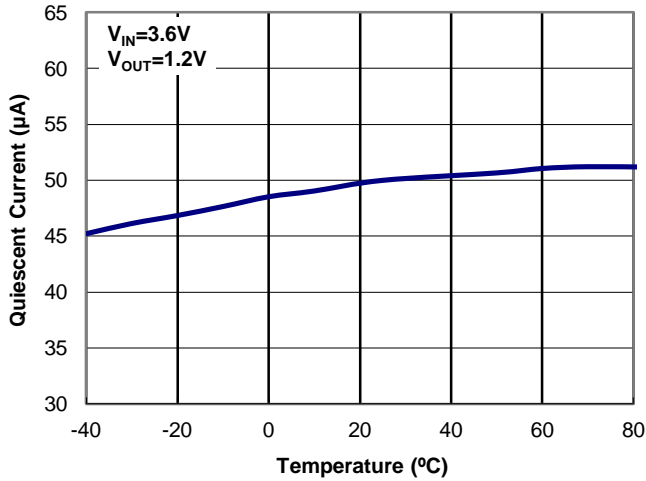

Figure 10. Quiescent Current vs. Temperature

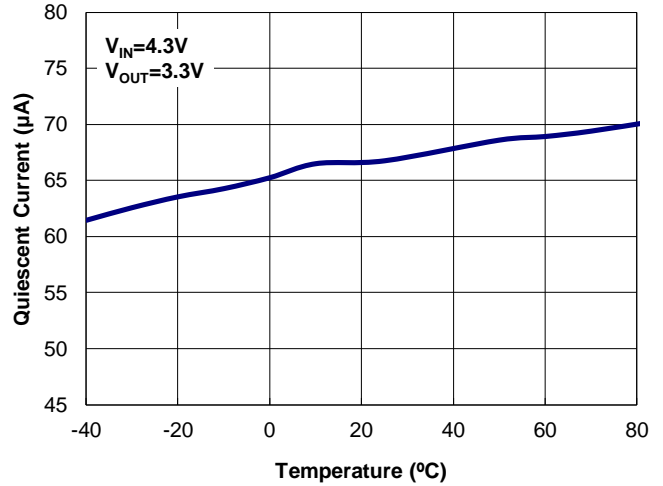

Figure 11. Quiescent Current vs. Temperature

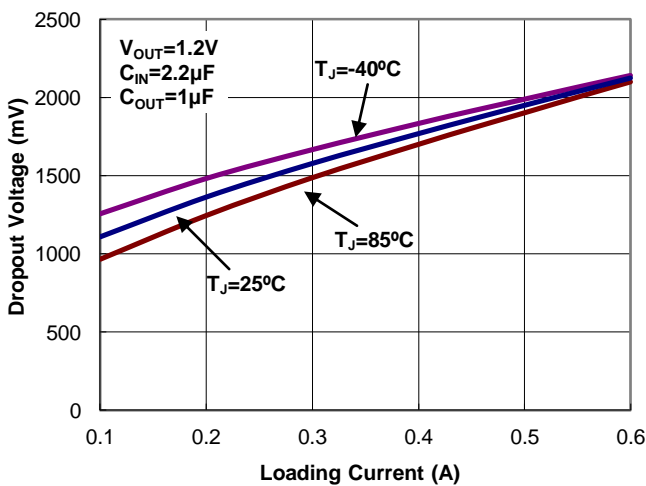

Figure 12. Dropout Voltage vs. Loading Current

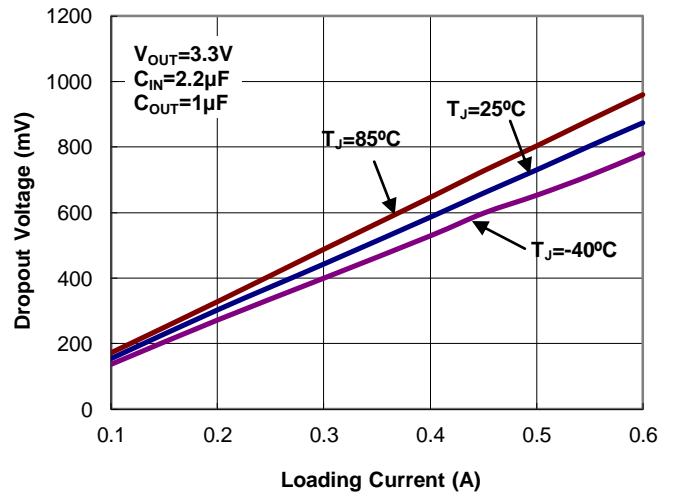

Figure 13. Dropout Voltage vs. Loading Current

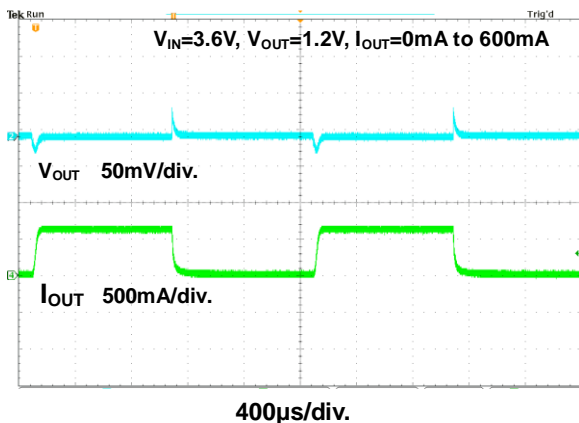

Figure 14. Load Transition Response

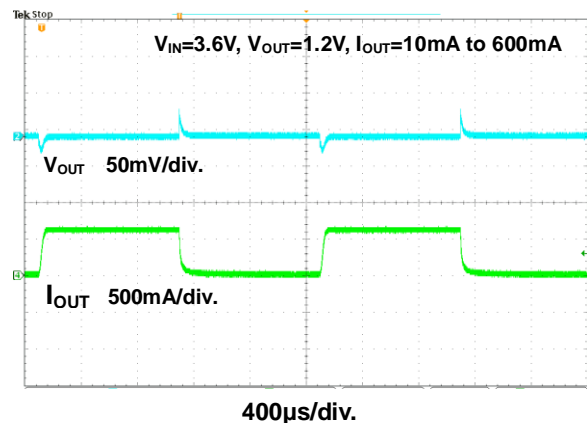

Figure 15. Load Transition Response

Typical Performance Curves (Continued)

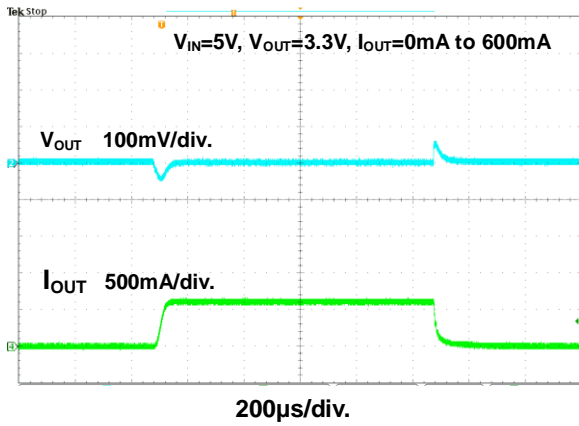

Figure 16. Load Transition Response

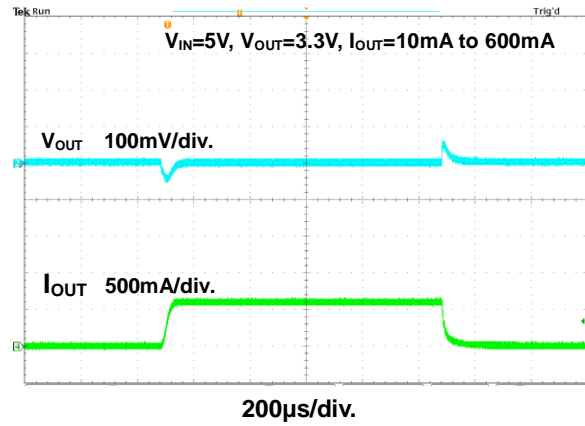

Figure 17. Load Transition Response

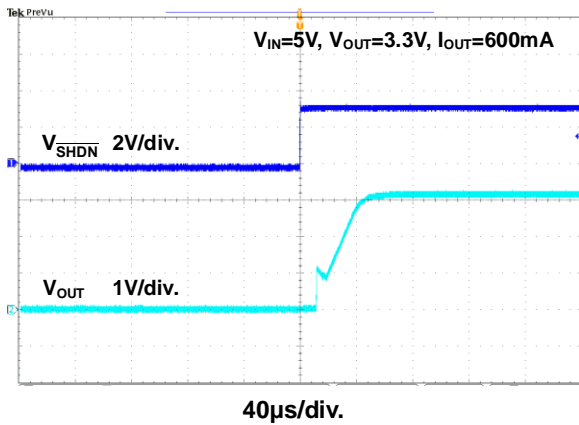

Figure 18. Enable Test

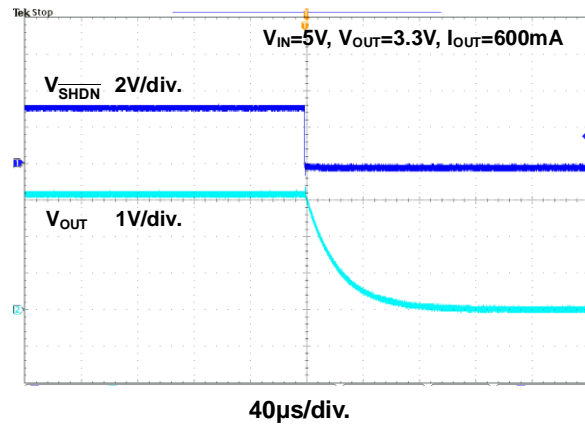

Figure 19. Shutdown Test

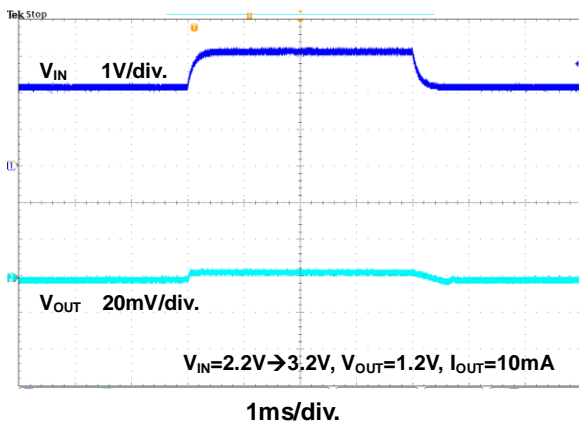

Figure 20. Line Transition Response

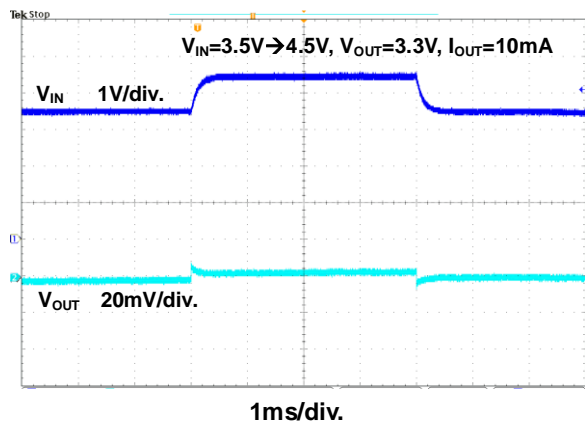

Figure 21. Line Transition Response

Application Information

The FP6166 is a low dropout linear regulator which provides 600mA output current at dropout voltage about 890mV. Current limit and on chip thermal shutdown features provide protection against any combination of overload or ambient temperature which exceeds maximum junction temperature.

Output Voltage Setting

The output can be set to fixed or adjustable mode. The internal output mode comparator compares the ADJ pin voltage with 166mV reference. If the ADJ pin voltage is higher than 166mV, the FP6166 will be set into adjustable output mode and the non-inverting input of the error amplifier will be connected to the external voltage divider. If the ADJ pin voltage is lower than 166mV, the FP6166 will be set into fixed output mode and the non-inverting input of the error amplifier will be connected to the internal voltage divider.

The output voltage V_{OUT} is set by using a resistive divider R1 and R2. Thus the output voltage is:

$$V_{OUT}=1V \times \left(1 + \frac{R1}{R2}\right)$$

Output and Input Capacitor

The FP6166 regulator is designed to stabilize with a wide range of output capacitors. The ESR of the output capacitor affects stability. Larger value of the output capacitor decreases the peak deviations and improves transient response for larger current changes.

The capacitor types (aluminum, ceramic and tantalum) have different characterizations such as temperature and voltage coefficients. All ceramic capacitors are manufactured with a variety of dielectrics, each with different behavior across temperature and applications. Common dielectrics used are X5R, X7R and Y5V. It is recommended to use 1 μ F to 10 μ F X5R or X7R dielectric ceramic capacitors with 30m Ω to 50m Ω ESR range between device outputs and ground for stability. The FP6166 is designed to stabilize with low ESR ceramic capacitors, and higher values of capacitors and ESR could improve output stability. The ESR of output capacitor is very important because it generates a zero to provide phase lead for loop stability.

There is no requirement for the ESR on the input capacitor, but its voltage and temperature coefficient have to be considered for device application environment.

Protection Features

In order to prevent overloading or thermal condition damaging the device, FP6166 contains internal thermal and current limit functions which are designed to protect the device. It will rapidly shut off PMOS pass element during over-temperature condition.

Thermal Consideration

The power handling capability of the device will be limited by allowable operation junction temperature (125°C). The power dissipated by the device will be estimated by $P_D = I_{OUT} \times (V_{IN} - V_{OUT})$. The power dissipation should be lower than the maximum power dissipation listed in "Absolute Maximum Ratings" section.

Shutdown Operation

The FP6166 will be shut down by pulling the \overline{SHDN} input low and turned on by driving the \overline{SHDN} high. If \overline{SHDN} pin is floating, the FP6166 will shut down because \overline{SHDN} pin has built-in a pull low resistor (refer to Block Diagram).

Outline Information

SOT-23-5 Package (Unit: mm)

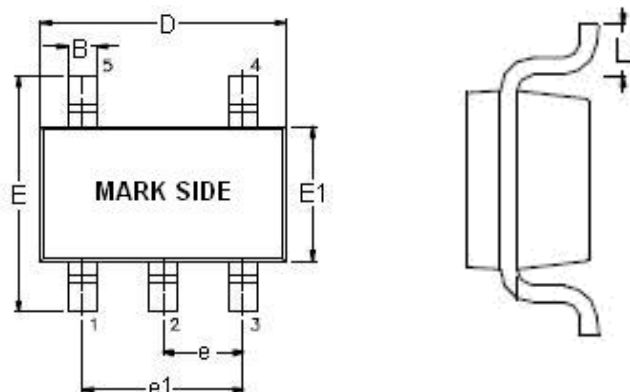

SYMBOLS UNIT	DIMENSION IN MILLIMETER	
	MIN	MAX
A	0.90	1.45
A1	0.00	0.15
A2	0.90	1.30
B	0.30	0.50
D	2.80	3.00
E	2.60	3.00
E1	1.50	1.70
e	0.90	1.00
e1	1.80	2.00
L	0.30	0.60

Note : Followed From JEDEC MO-178-C.

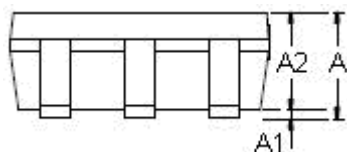

Carrier Dimensions

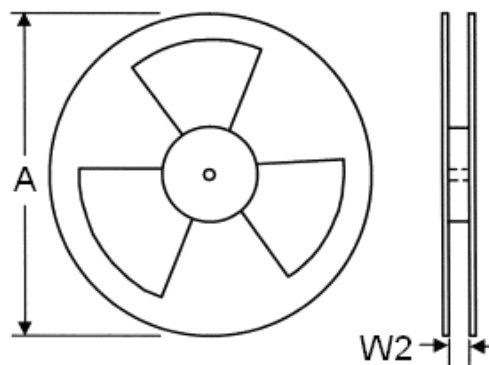
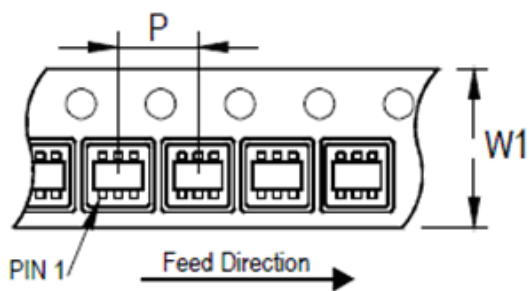

Tape Size (W1) mm	Pocket Pitch (P) mm	Reel Size (A)		Reel Width (W2) mm	Empty Cavity Length mm	Units per Reel
		in	mm			
8	4	7	180	8.4	300~1000	3,000

Outline Information (Continued)

SOP-8 Package (Unit: mm)

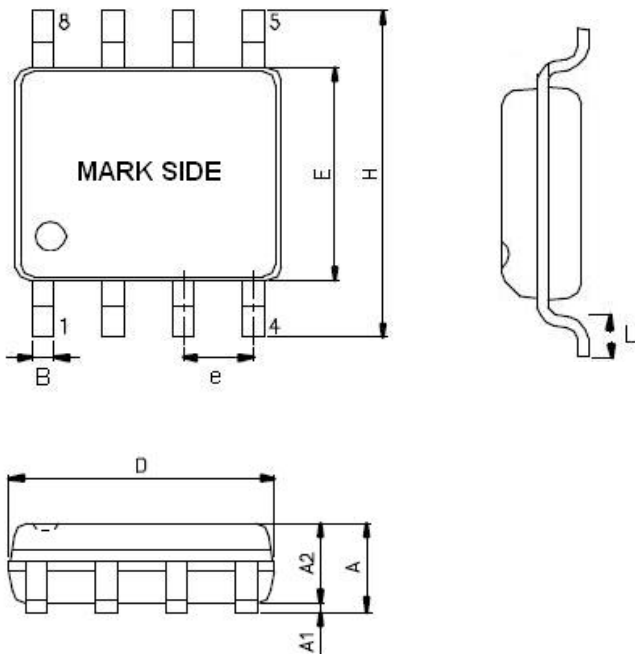

SYMBOLS UNIT	DIMENSION IN MILLIMETER	
	MIN	MAX
A	1.35	1.75
A1	0.10	0.25
A2	1.25	1.50
B	0.31	0.51
D	4.80	5.00
E	3.80	4.00
e	1.20	1.34
H	5.80	6.20
L	0.40	1.27

Note : Followed from JEDEC MO-012-E

Carrier Dimensions

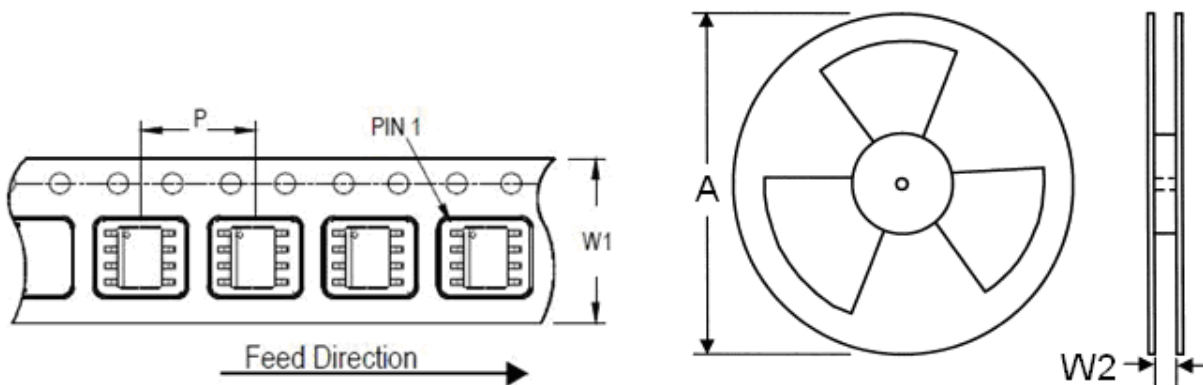

Tape Size (W1) mm	Pocket Pitch (P) mm	Reel Size (A)		Reel Width (W2) mm	Empty Cavity Length mm	Units per Reel
		in	mm			
12	8	13	330	12.4	400~1000	2,500

Life Support Policy

Fitipower's products are not authorized for use as critical components in life support devices or other medical systems.