

Synchronous Buck PWM DC-DC Controller

Description

The FP6326/A is designed to drive two N-channel MOSFETs in a synchronous rectified buck topology. It provides the output adjustment, internal soft-start, frequency compensation networks, monitoring and protection functions into a single package.

The IC operating at fixed 300kHz or 600kHz frequency provides simple, single feedback loop, voltage mode control with fast transient response. The resulting PWM duty ratio ranges from 0-100%.

The FP6326/A features over current protection. The output current is monitored by sensing the voltage drop across the R_{DS-ON} of the low side MOSFET which eliminates the need for a current sensing resistor.

This device is available in SOP-8 package.

Features

- Operates from +5V or +12V
- High Output Current
- Drives Two Low Cost N-Channel MOSFETs
- Fast Transient Response
- Simple Single-Loop Control Design (Voltage-Mode PWM Control)
- Internal Soft-Start
- Over-Current Fault Monitor
- Over-Voltage Protection
- Under-Voltage Protection
- SOP-8 Package
- RoHS Compliant

Applications

- Motherboard
- Graphic Card
- Telecomm Equipments
- High Power DC-DC Regulators
- Servers

Pin Assignment

SO Package (SOP-8)

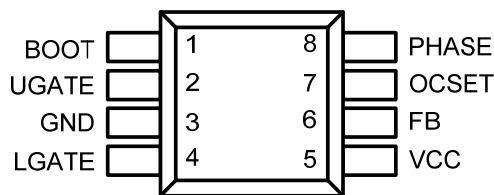
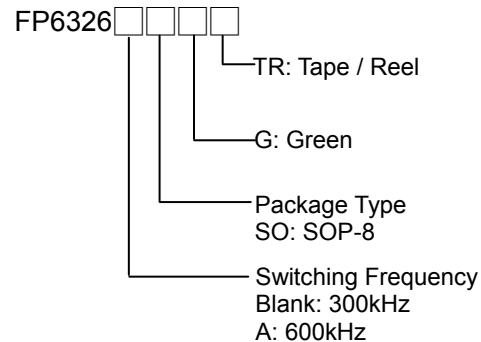

Figure 1. Pin Assignment of FP6326/A

Ordering Information



FITIPOWER DCC
CONTROL COPY

Typical Application Circuit

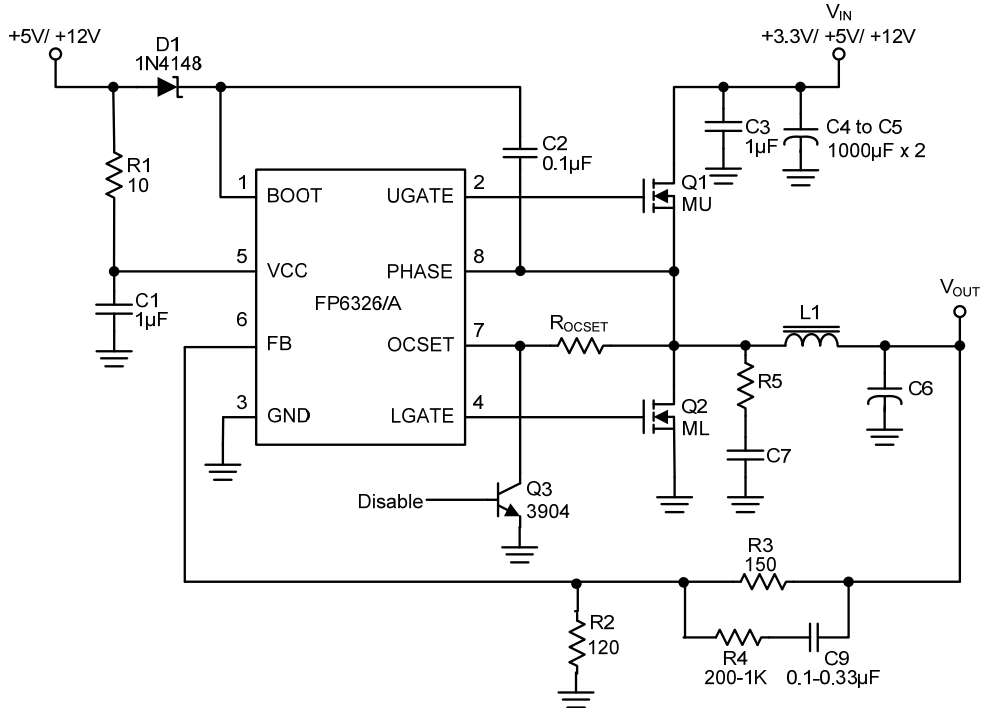

Figure 2. Typical Application Circuit of FP6326/A

Functional Pin Description

Pin Name	Pin Function
BOOT	This pin provides bias voltage to the high side MOSFET Driver. A bootstrap circuit may be to create a BOOT voltage suitable to drive a standard N-Channel MOSFET.
UGATE	Connect UGATE to the high side MOSFET gate. This pin is monitored by the adaptive shoot-through protection circuitry to determine when the high side MOSFET has turned off.
GND	Ground.
LGATE	Connect LGATE to the low side MOSFET gate. This pin is monitored by the adaptive shoot-through protection circuitry to determine when the high side MOSFET has turned off.
VCC	Power Pin.
FB	Feedback Pin. The typical reference voltage is 0.8V.
OCSET	Shutdown Control and connect a resistance (R_{OCSET}) for over current setting.
PHASE	Connect the PHASE pin to the high side MOSFET source.

FITIPOWER DGC CONTROL COPY

Absolute Maximum Ratings

- VCC to GND ----- -0.3V to +16V
- BOOT, $V_{BOOT}-V_{PHASE}$ ----- -0.3V to +16V
- PHASE ----- -5V to +16V
- UGATE ----- $V_{PHASE} - 0.3V$ to $V_{BOOT} + 0.3V$
- LGATE ----- -0.3V to $VCC+0.3V$
- FB,OCSET to GND ----- -0.3V to +6V
- Continuous Power Dissipation ($T_A=+25^{\circ}C$) ----- +630mW
- Package Thermal Resistance, SOP-8 (θ_{JA}) ----- +160 $^{\circ}C/W$
- Junction Temperature ----- +150 $^{\circ}C$
- Storage Temperature Range----- -65 $^{\circ}C$ to +150 $^{\circ}C$
- Lead Temperature (Soldering, 10sec.) ----- +260 $^{\circ}C$

Note1 : Stresses beyond those listed under "Absolute Maximum Ratings" may cause permanent damage to the device.

Recommended Operating Conditions

- Supply Voltage, VCC ----- $5V \pm 5\%$, $12V \pm 10\%$
- Operating Temperature Range ----- -40 $^{\circ}C$ to +85 $^{\circ}C$

FITIPOWER DCC
 CONTROL COPY

Block Diagram

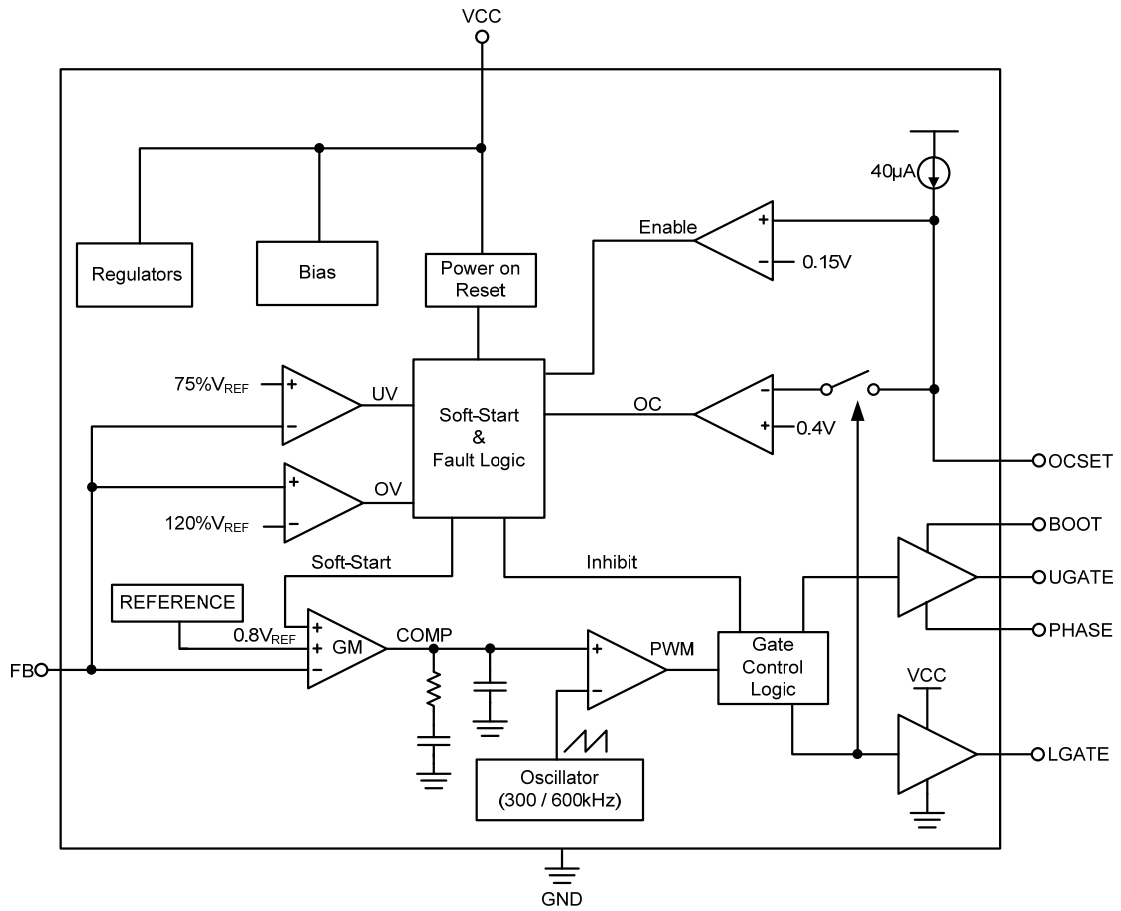

Figure 3. Block Diagram of FP6326/A

FITIPOWER DCC
CONTROL COPY

Electrical Characteristics

($V_{CC}=12V$, $T_A=25^{\circ}C$, unless otherwise specified)

Parameter	Symbol	Conditions	Min	Typ	Max	Unit
INPUT						
VCC Under Voltage Lockout	V_{UVLO}	V_{CC} rising	3.7	4.1	4.5	V
UVLO Hysteresis		V_{CC} falling		0.45		V
Quiescent Current	I_{CC}	U_{GATE} and L_{GATE} open		6	15	mA
ERROR AMPLIFIER						
Feedback Voltage	V_{FB}		0.784	0.8	0.816	V
FB Input Bias Current	I_{FB}	$V_{FB}=1V$		0.1		μA
Open Loop DC Gain (Note2)	A_O			85		dB
OSCILLATOR						
Frequency	F_{OSC}	$V_{CC}=12V$ FP6326	250	300	350	kHz
Frequency	F_{OSC}	$V_{CC}=12V$ FP6326A	500	600	700	kHz
Ramp Amplitude	ΔV_{OSC}	$V_{CC}=12V$		1.5		Vp-p
GATE DRIVERS						
Upper Gate Source	I_{UGATE}	$V_{BOOT}-V_{PHASE}=12V$, $V_{UGATE}-V_{PHASE}=6V$	0.6	1		A
Upper Gate Sink	R_{UGATE}	$V_{BOOT}-V_{PHASE}=12V$, $V_{UGATE}-V_{PHASE}=1V$		2	5	Ω
Lower Gate Source	I_{LGATE}	$V_{CC}=12V$, $V_{LGATE}=6V$	0.6	1		A
Lower Gate Sink	R_{LGATE}	$V_{CC}=12V$, $V_{LGATE}=1V$		2	5	Ω
Dead Time (Note2)	T_{DT}				100	ns
PROTECTION						
FB Under-Voltage Trip		FB Falling	70	75	80	%
FB Over-Voltage Trip				120		%
OCSET Current Source	I_{OCSET}	$V_{PHASE}=0V$	35	40	45	μA
Soft-Start Interval (Note2)	T_{SS}		2	3.5		ms

Note2: Guarantee by design.

FITIPOWER DGC
CONTROL COPY

Typical Performance Curves

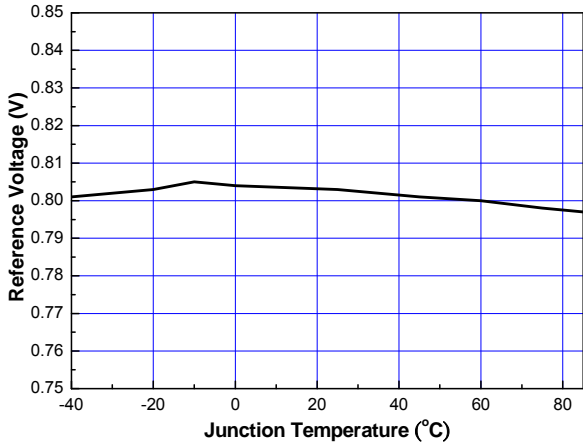

Figure 4. Reference Voltage vs. Junction Temperature

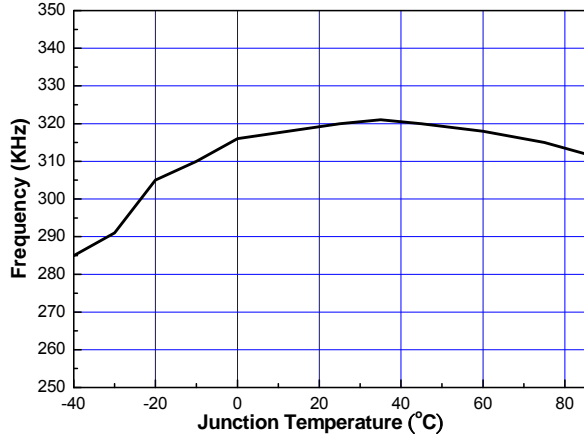

Figure 5. Frequency vs. Junction Temperature

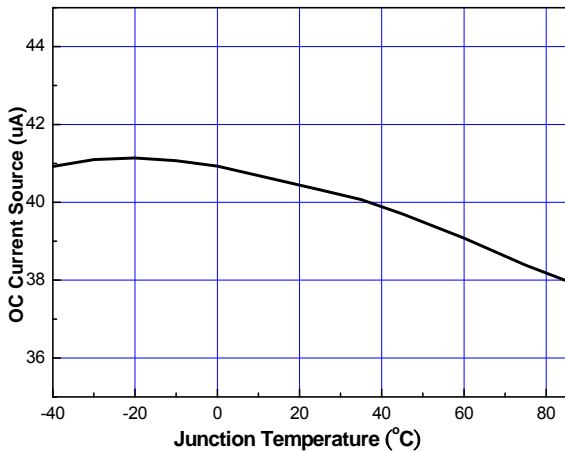

Figure 6. OC Current Source vs. Junction Temperature

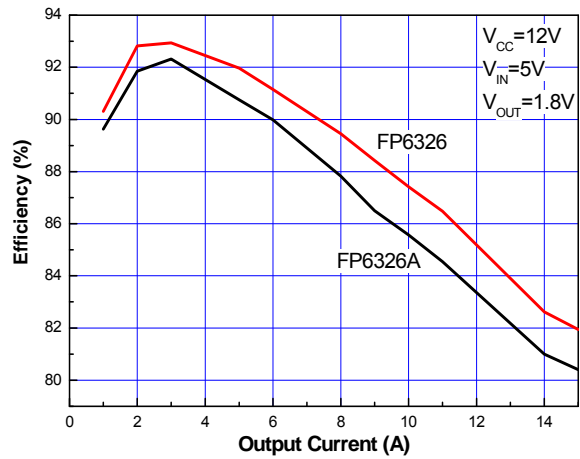

Figure 7. Efficiency vs. Output Current

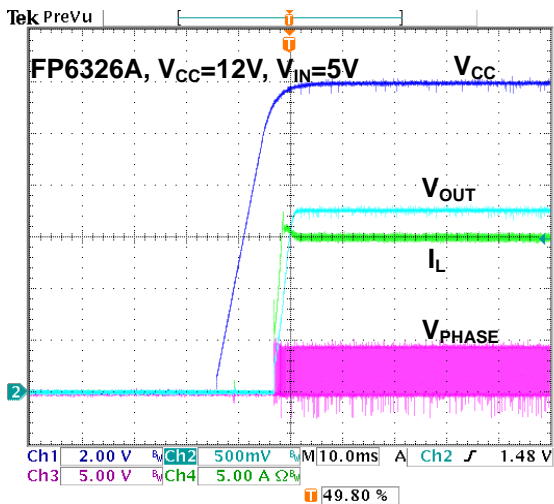

Figure 8. Power On at 15A Loading

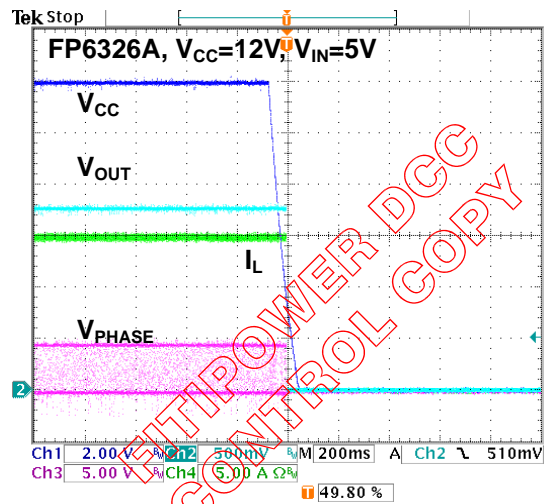

Figure 9. Power OFF at 15A Loading

Typical Performance Curves (Continued)

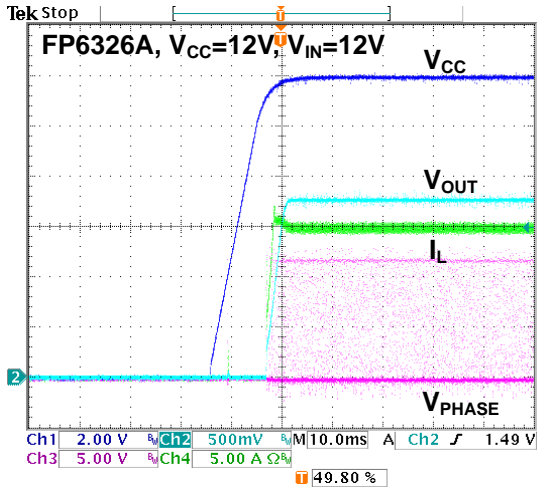

Figure 10. Power On at 15A Loading

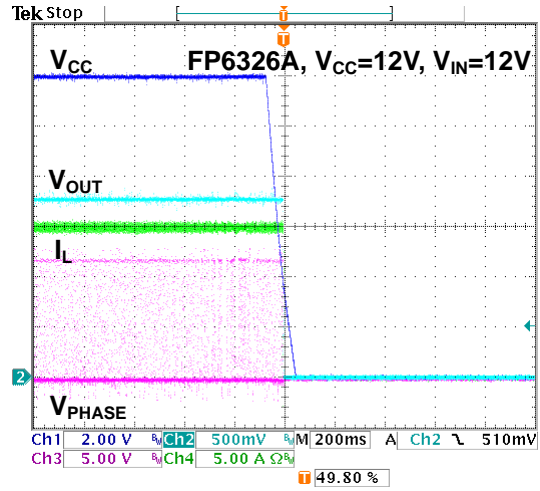

Figure 11. Power Off at 15A Loading

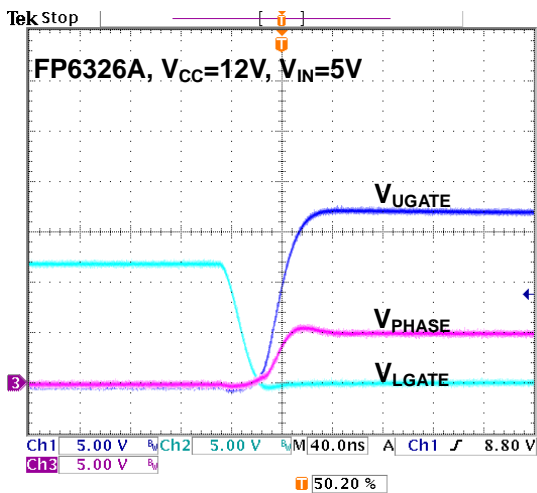

Figure 12. Switching waveform (UGATE rising) $I_{OUT}=0A$

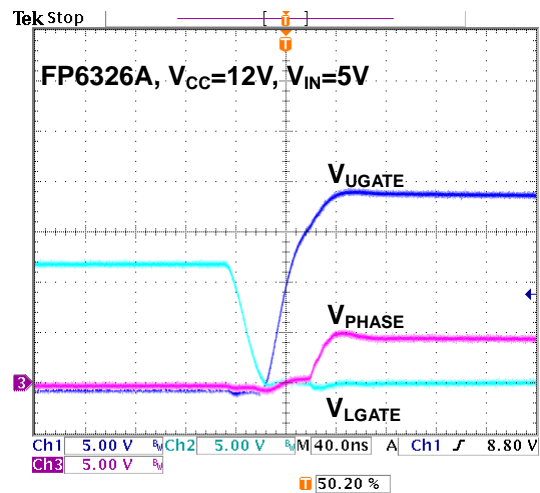

Figure 13. Switching waveform (UGATE rising) $I_{OUT}=15A$

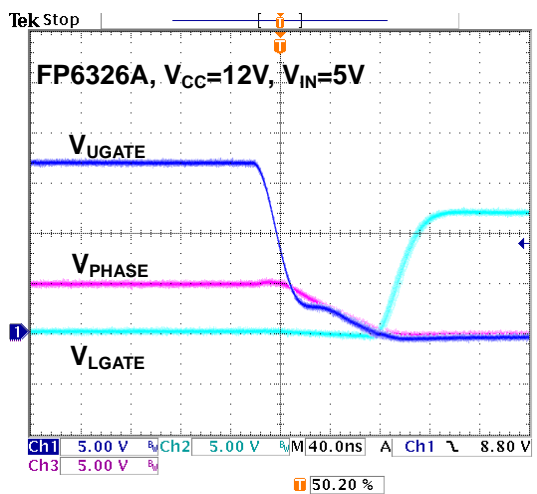

Figure 14. Switching waveform (UGATE Falling) $I_{OUT}=0A$

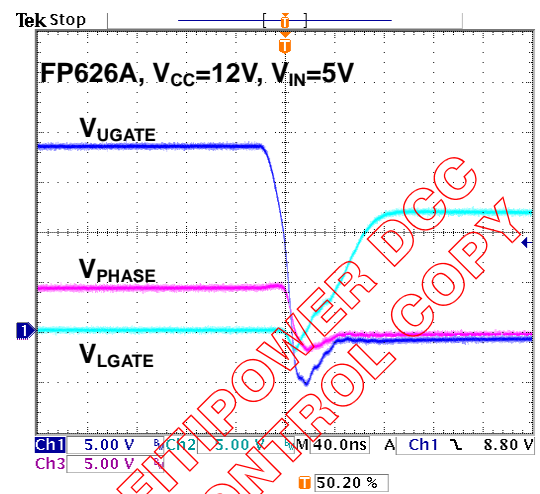

Figure 15. Switching waveform (UGATE Falling) $I_{OUT}=15A$

Typical Performance Curves (Continued)

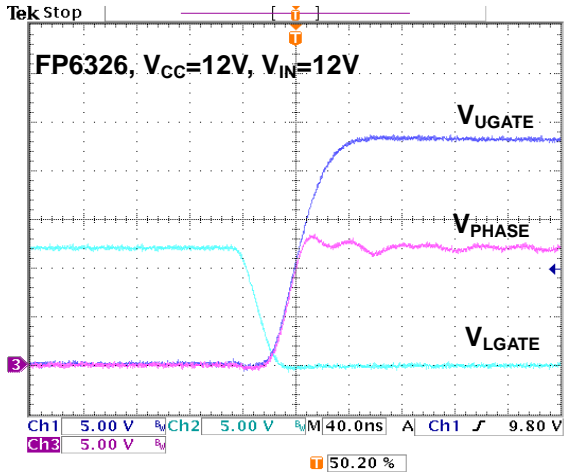

Figure 16. Switching waveform (UGATE rising) $I_{OUT}=0A$

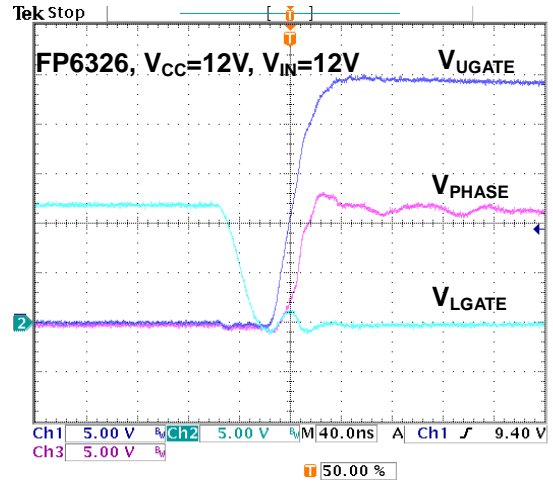

Figure 17. Switching waveform (UGATE rising) $I_{OUT}=15A$

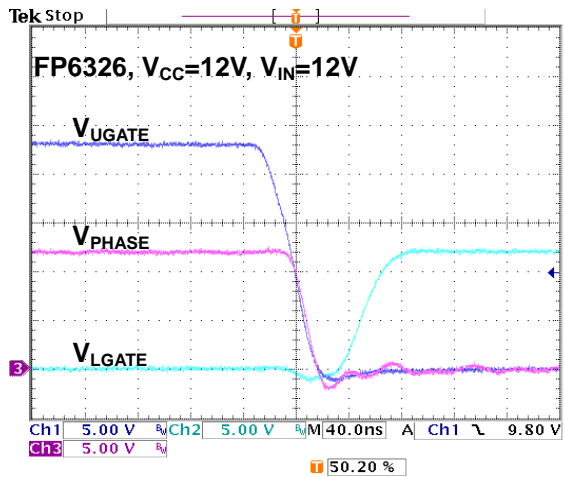

Figure 18. Switching waveform (UGATE Falling) $I_{OUT}=0A$

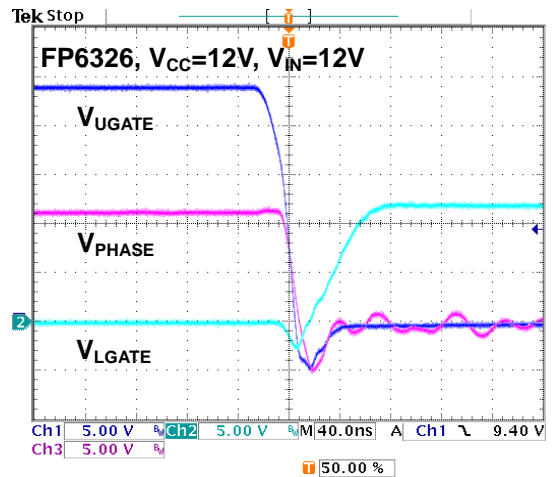

Figure 19. Switching waveform (UGATE Falling) $I_{OUT}=15A$

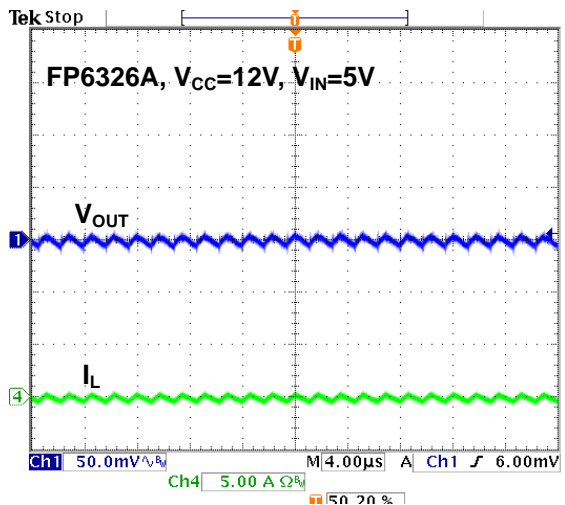

Figure 20. Output Ripple at 15A

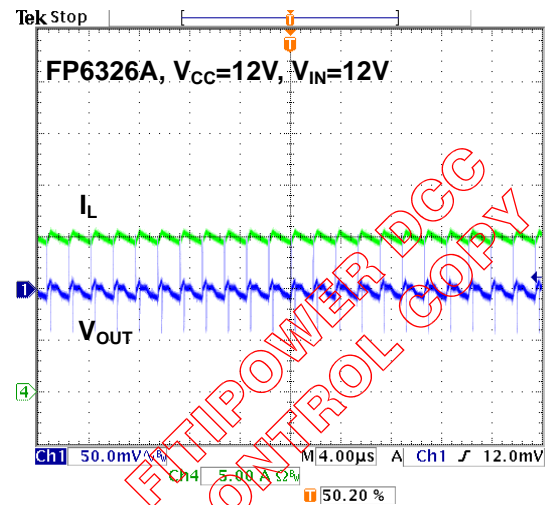

Figure 21. Output Ripple at 15A

Typical Performance Curves (Continued)

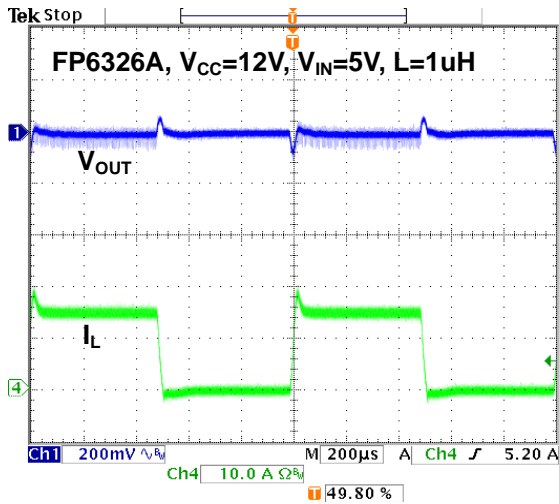

Figure 22. Transient test:1kHz, Slew rate:2.5A/us

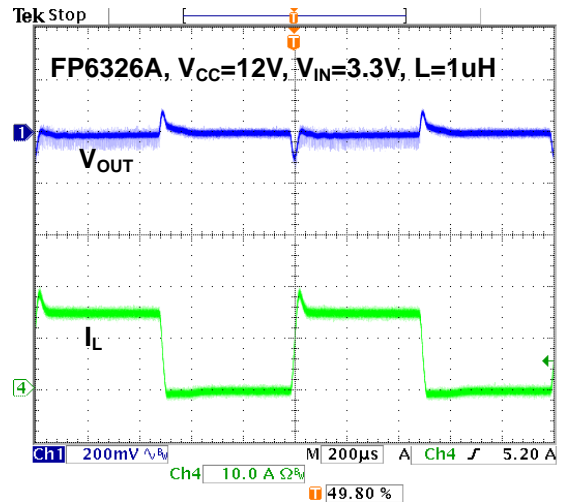

Figure 23. Transient test:1kHz, Slew rate:2.5A/us

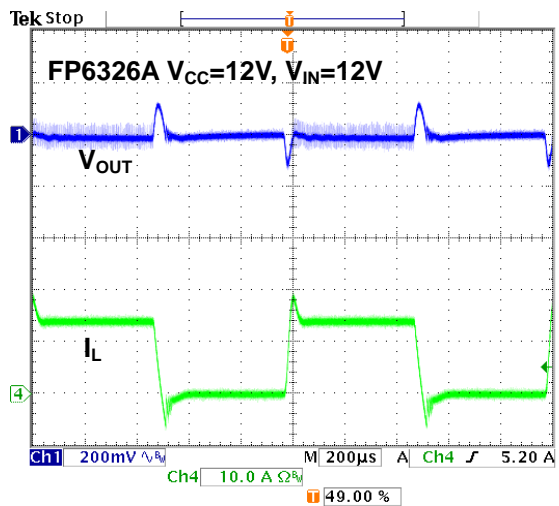

Figure 24. Transient test :1kHz, Slew rate: 2.5A/us

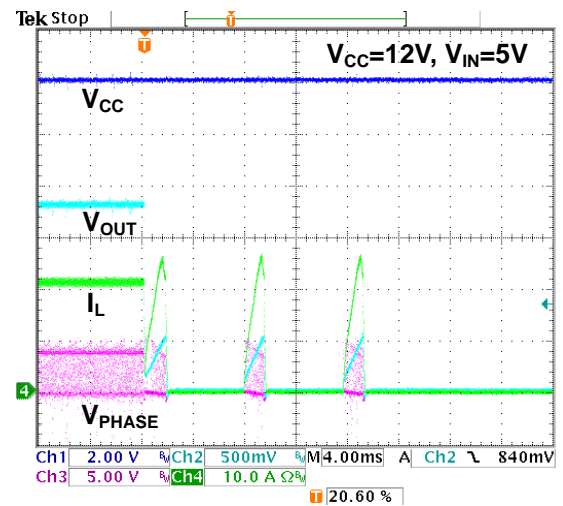

Figure 25. OCP Using DC Loading

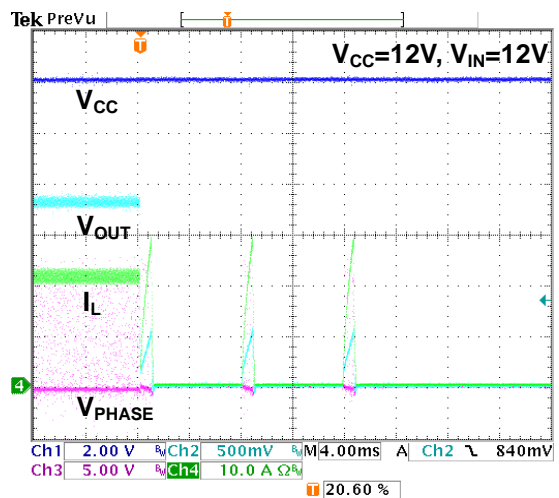

Figure 26. OCP Using DC Loading

FITIPOWER DCC
CONTROL COPY

Functional Description

Initialization

The Power-On Reset (POR) function continually monitors the input supply voltage and the enable function. The POR monitors the bias voltage at the VCC pin

When VCC power is ready, the FP6326/A starts to ramp up the output voltage up to the target voltage.

Soft-Start

The FP6326/A features soft-start to limit inrush current and control the output voltage rise at start-up. The soft-start is accomplished by ramping the internal reference input from 0V to 0.8V. The soft-start interval is 3.5ms typical.

Over-Current Protection

The over-current function protects the converter a shorted output by using the low side MOSFET on-resistance R_{DS-ON} to monitor the current. This method enhances the converter's efficiency and reduces cost by eliminating a current sensing resistor.

The over-current function cycles the soft-start function in a hiccup mode to provide fault protection. After four times are counted, the high side and low side MOSFET will turn off and the output is latched off. A resistor (R_{OCSET}), connected from OCSET pin to the source of high side MOSFET and the drain of low side MOSFET to set the over-current triple level. An internal 40uA(typical) current source develops the voltage across the R_{OCSET} . The over-current setting equation is shown as below:

$$I_{OCSET} = \frac{40\mu A \times R_{OCSET} - 0.4V}{R_{DS-ON}}$$

Shutdown

Connecting a small transistor to OCSET pin, and pulling the OCSET voltage less than 0.15V can shutdown the FP6326/A. At this condition, the FP6326/A is shutdown and high side and low side MOSFETS are turned off. The output is floating.

Under-Voltage Protection

The under-voltage function monitors the FB voltage to protection the converter against the output short-circuit condition. The under-voltage threshold is $0.75 \times V_{REF}$. The UV has 20us triggered delay. When UVP happens, the converter re-starts up without latching off.

Over-Voltage Protection

The over-voltage function monitors the FB voltage to protection the converter against the output from over-voltage. When the output voltage rises to $1.2 \times V_{REF}$, the FP6326/A turns on the low side MOSFET until the output voltage below the OVP threshold.

FITIPOWER DCC
CONTROL COPY

Application Information

Introduction

The FP6326/A integrated circuit is a synchronous PWM controller, it operates over a wide input voltage range. Being low cost, it is a very popular choice of PWM controller. This section will describe the FP6326/A application suggestion. The operation and the design of this application will also be discussed in detail.

Design Procedures

This section will describe the steps to design synchronous buck system, and explains how to construct basic power conversion circuits including the design of the control chip functions and the basic loop.

(1) Synchronous Buck Converter

Since this is a buck output system, the first quantity to be determined is the duty cycle value. The formula calculated the PWM duty ratio, apply to the system which we propose to design:

$$\text{Duty ratio } D = \frac{V_O + V_{DS(\text{sat}), \text{Lowside } N}}{V_{IN} - V_{DS(\text{sat}), \text{Highside } N} + V_{DS(\text{sat}), \text{Lowside } N}} = \frac{T_{ON}}{T_S}$$

(2) Inductor Selection

To find the inductor value it is necessary to consider the inductor ripple current. Choose an inductor which operated in continuous mode down to 10 percent of the rated output load:

$$\Delta I_L = 2 \times 10\% \times I_O$$

The inductor "L" value for this system is connected to be:

$$L \geq \frac{(V_{IN} - V_{DS(\text{sat})} - V_O) \times D_{\text{MIN}}}{\Delta I_L \times f_S}$$

If the core loss is a problem, increasing the inductance of L will be helpful.

(3) Output Capacitor Selection

a. The output capacitor is required to filter the output noise and provide regulator loop stability. When selecting an output capacitor, the important capacitor parameters are; the 100kHz Equivalent Series Resistance (ESR), the RMS ripples current rating, the voltage rating, and capacitance value. For the output capacitor, the ESR value is the most important parameter.

The ESR can be calculated from the following formula.

$$\text{ESR} = \left(\frac{V_{\text{RIPPLE}}}{\Delta I_L} \right)$$

An aluminum electrolytic capacitor's ESR value is related to the capacitance and its voltage rating. In most case, higher voltage electrolytic capacitors have lower ESR values. Most of the time, capacitors with much higher voltage ratings may be needed to provide the low ESR values required for low output ripple voltage.

- b. The capacitor voltage rating should be at least 1.5 times greater than the output voltage, and often much higher voltage ratings are needed to satisfy the low ESR requirements needed for low output ripple voltage.

(3) Output N-channel MOSFET Selection

- a. The current ability of the output N-channel MOSFETs must be at least more than the peak switching current I_{PK} . The voltage rating V_{DS} of the N-channel MOSFETs should be at least 1.25 times the maximum input voltage. Choose the low R_{DS-ON} MOSFETs for reducing the conduction power loss. Choose the low C_{ISS} MOSFETs for reducing the switching loss. But most of time, the two factors are trade-off. Consider the system requirement and define the MOSFETs rating.
- b. The MOSFETs must be fast (switch time) and must be located close to the FP6326/A using short leads and short printed circuit traces. In case of a large output current, we must layout a copper to reduce the temperature of these two MOSFETs.

(4) Input Capacitor Selection

- a. The RMS current rating of the input capacitor can be calculated from the next page formula table.
- b. This capacitor should be located close to the IC using short leads and the volt age rating should be approximately 1.5 times the maximum input voltage.

Application Information (Continued)

Calculating Formula

	$V_{OUT} = V_{FB} \times ((R3/R2) + 1)$
	$L \geq \frac{[V_{IN(min)} - V_{DS(SAT)} - V_{OUT}] \times T_{ON(max)}}{\Delta I_L}$ $I_{RIPPLE} = I_{LOAD(max)} - I_{LOAD(min)}$
C_{OUT}	$ESR = \left[\frac{V_{RIPPLE}}{\Delta I_L} \right]$ $V_{DC-Rating} \geq 1.5 \times V_{OUT}$
C_{IN}	$I_{IN(rms)} = I_{OUT} \times \sqrt{D(1-D)}$ $V_{DC-rating} \geq 1.5 \times V_{IN(max)}$
D	$T_{ON} / (T_{ON} + T_{OFF})$
	V_{OUT} / V_{IN}
ΔI_L	$2 \times 10\% \times I_O$
$I_{IN(rms)}$	$I_{OUT} \times \sqrt{D(1-D)}$

Layout Notice

When designing a high frequency switching regulated power supply, layout is very important. Using a good layout can solve many problems associated with these types of supplies. The problems due to a bad layout are often seen at high current levels and are usually more obvious at large input to output voltage differentials. Some of the main problems are loss of regulation at high output current and/or large input to output voltage differentials, excessive noise on the output and switch waveforms, and instability. Using the simple guidelines that follow will help minimize these problems.

(1) Inductor

Always try to use a low EMI inductor with a ferrite type closed core. Open core can be used if they have low EMI characteristics and are located a bit more away from the low power traces and components.

(2) Feedback

Try to put the feedback trace as far from the inductor and noisy power traces as possible. You would also like the feedback trace to be as direct as possible and somewhat thick. These two sometimes involve a trade-off, but keeping it away from inductor EMI and other noise sources is the more critical of the two. It is often a good idea to run the feedback trace on the side of the PCB opposite of the inductor with a ground plane separating the two.

(3) Filter Capacitors

When using a low value ceramic input filter capacitor, it should be located as close to the VIN pin of the IC as possible. This will eliminate as much trace inductance effects as possible and give the internal IC rail a cleaner voltage supply. Sometimes using a small resistor between VCC and IC VCC pin will more useful because the RC will be a low-pass filter. Some designs require the use of a feed-forward capacitor connected from the output to the feedback pin as well, usually for stability reasons.

(4) Compensation

If external compensation components are needed for stability, they should also be placed closed to the IC. Surface mount components are recommended here as well for the same reasons discussed for the filter capacitors.

(5) Traces and Ground Plane

Make all of the power (high current) traces as short, direct, and thick as possible. It is a good practice on a standard PCB board to make the traces an absolute minimum of 15mils (0.381mm) per Ampere. The inductor, output capacitors, and output diode (In synchronous case, means the low side switch) should be as close to each other possible. This will reduce lead inductance and resistance as well which in turn reduces noise spikes, ringing, and resistive losses which produce voltage errors. The grounds of the IC, input capacitors, output capacitors, and output diode (or switch, if applicable) should be connected close together directly to a ground plane. It would also be a good idea to have a ground plane on both sides of the PCB. For multi-layer boards with more than two layers, a ground plane can be used to separate the power plane (where the power traces and components are) and the signal plane (where the

Application Information (Continued)

feedback and compensation and components are) for improved performance. It is good practice to use one standard via per 200mA of current if the trace will need to conduct a significant amount of current from one plane to the other. Due to the way switching regulators operate, there are power on and power off states. During each state there will be a current loop made by the power components that are currently conducting. Place the power components so that during each of the two states the current loop is conducting in the same direction.

Board Layout

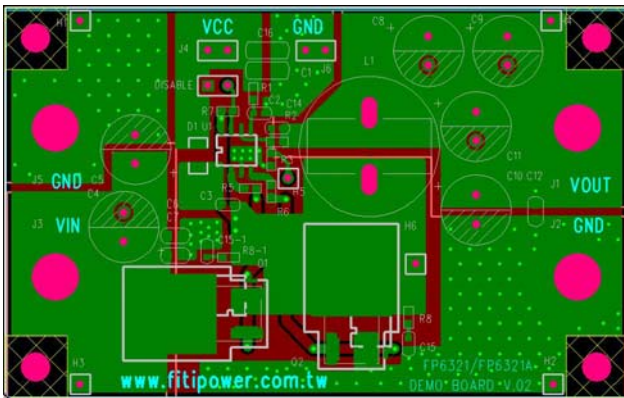

Figure 27. Top Layer

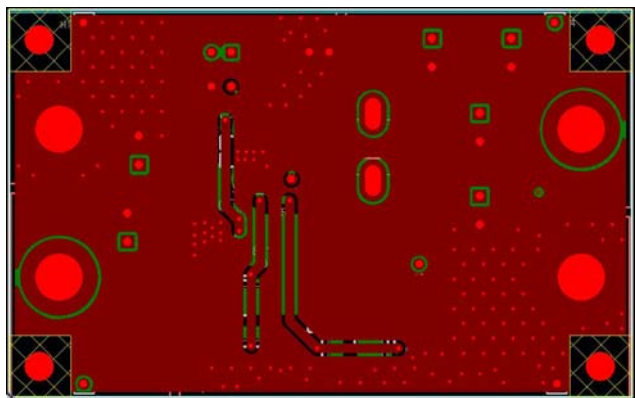

Figure 28. Bottom Layer

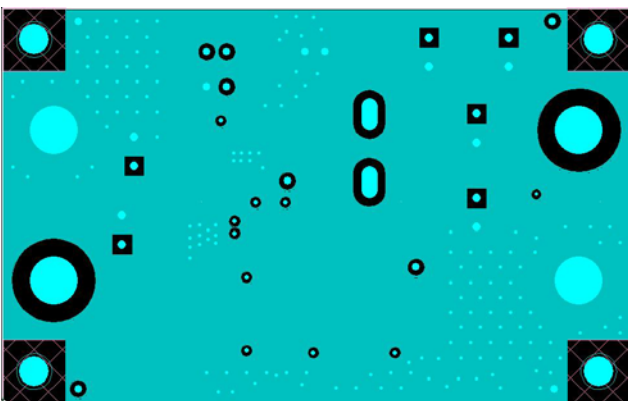

Figure 29. Inner Layer 2

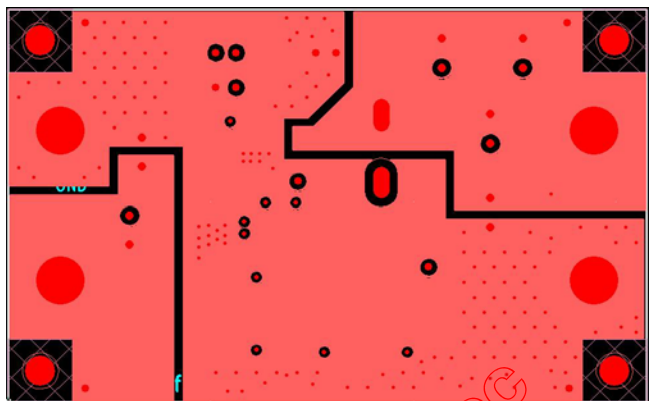
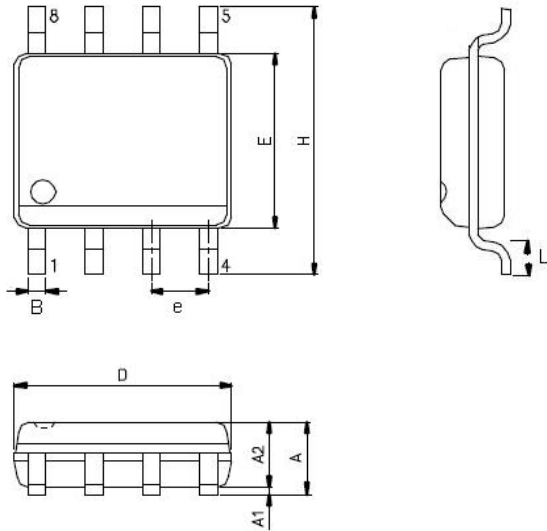

Figure 30. Inner layer 3

FITIPOWER DOC
CONTROL COPY

Outline Information

SOP- 8 Package (Unit: mm)



SYMBOLS UNIT	DIMENSION IN MILLIMETER	
	MIN	MAX
A	1.35	1.75
A1	0.05	0.25
A2	1.30	1.50
B	0.31	0.51
D	4.80	5.00
E	3.80	4.00
e	1.20	1.34
H	5.80	6.20
L	0.40	1.27

Note 1 : Followed From JEDEC MO-012-E.

**FITIPOWER DCC
CONTROL COPY**

Life Support Policy

Fitipower's products are not authorized for use as critical components in life support devices or other medical systems.