



FPF1103 / FPF1104

Advance Load Management Switch

Features

- 1.2V to 4V Input Voltage Operating Range
- Typical $R_{DS(ON)}$:
 - 35m Ω at $V_{IN}=3.3V$
 - 55m Ω at $V_{IN}=1.8V$
 - 85m Ω at $V_{IN}=1.2V$
- Slew Rate Control with t_R : 65 μs
- Output Discharge Function on FPF1104
- Low <1 μA Quiescent Current at $V_{ON}=V_{IN}$
- ESD Protected: Above 4000V HBM, 2000V CDM
- GPIO/CMOS-Compatible Enable Circuitry

Applications

- Mobile Devices and Smart Phones
- Portable Media Devices
- Digital Cameras
- Advanced Notebook, UMPC, MID
- Portable Medical Devices
- GPS and Navigation Equipment

Description

The FPF1103/04 are low R_{DS} P-channel MOSFET load switches of the IntelliMAX™ family. Integrated slew-rate control prevents inrush current from glitch supply rails with capacitive loads common in power applications.

The input voltage range operates from 1.2V to 4V to fulfill today's lowest ultra-portable device supply requirements. Switch control is by a logic input (ON-pin) capable of interfacing directly with low-voltage CMOS control signals and GPIOs in embedded processors.

Ordering Information

Part Number	Part Marking	Switch (Typical) At 1.8V _{IN}	Input Buffer	Output Discharge	ON Pin Activity	t _R	Eco Status	Package
FPF1103	Q9	55m Ω	CMOS	NA	Active HIGH	65 μs	Green	4-Ball, Wafer-Level Chip-Scale Package (WLCSP), 1.0 x 1.0mm, 0.5mm Pitch
FPF1104	QA	55m Ω	CMOS	65 Ω	Active HIGH	65 μs	Green	

 For Fairchild's definition of Eco Status, please visit: http://www.fairchildsemi.com/company/green/rohs_green.html.

Application Diagram

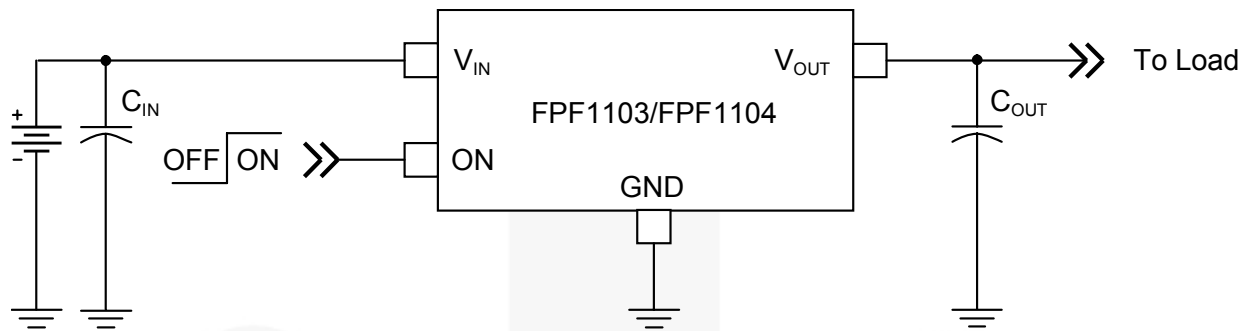

Figure 1. Typical Application

Notes:

1. C_{IN} = 1 μ F, X5R, 0603, for example Murata GRM185R60J105KE26
2. C_{OUT} = 1 μ F, X5R, 0805, for example Murata GRM216R61A105KA01

Block Diagram

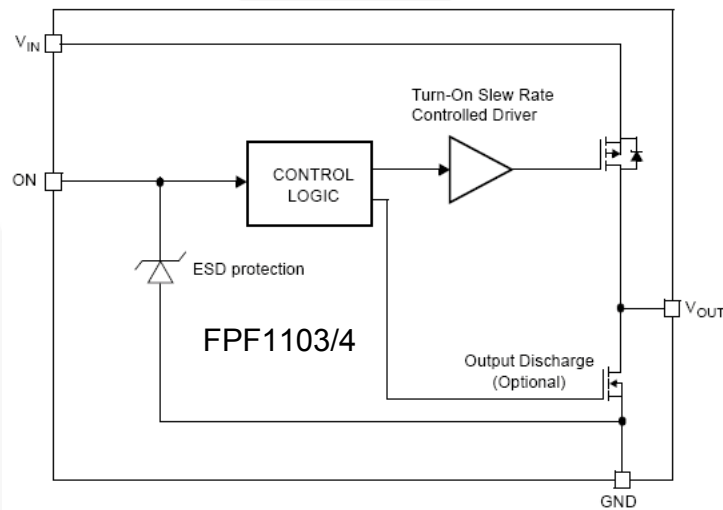

Figure 2. Block Diagram (Output Discharge for FPF1104 Only)

www.DataSheet4U.com

Pin Configurations

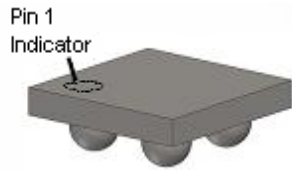

Figure 3. 1 x 1mm WLCSP Bumps Facing Down

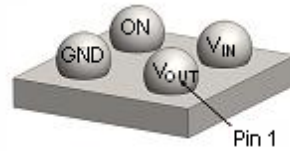

Figure 4. 1 x 1mm WLCSP Bumps Facing Up

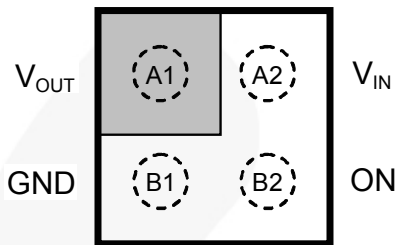

Figure 5. Pin Assignments (Top View)

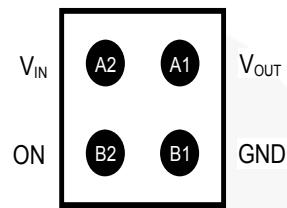

Figure 6. Pin Assignments (Bottom View)

Pin Definitions

Pin #	Name	Description
A1	V _{OUT}	Switch Output
A2	V _{IN}	Supply Input: Input to the Power Switch
B1	GND	Ground
B2	ON	ON/OFF Control, Active High

Absolute Maximum Ratings

Stresses exceeding the absolute maximum ratings may damage the device. The device may not function or be operable above the recommended operating conditions and stressing the parts to these levels is not recommended. In addition, extended exposure to stresses above the recommended operating conditions may affect device reliability. The absolute maximum ratings are stress ratings only.

Symbol	Parameter	Min.	Max.	Unit
V _{IN}	V _{IN} , V _{OUT} , V _{ON} to GND	-0.3	4.2	V
I _{SW}	Maximum Continuous Switch Current		1.2	A
P _D	Power Dissipation at T _A =25°C		1.0	W
T _{STG}	Storage Junction Temperature	-65	+150	°C
T _A	Operating Temperature Range	-40	+85	°C
Θ _{JA}	Thermal Resistance, Junction-to-Ambient	1S2P with 1 Thermal Via	95	°C/W
		1S2P without Thermal Via	187	
ESD	Electrostatic Discharge Capability	Human Body Model, JESD22-A114	4	kV
		Charged Device Model, JESD22-C101	2	

Recommended Operating Conditions

The Recommended Operating Conditions table defines the conditions for actual device operation. Recommended operating conditions are specified to ensure optimal performance to the datasheet specifications. Fairchild does not recommend exceeding them or designing to Absolute Maximum Ratings.

Symbol	Parameter	Min.	Max.	Unit
V _{IN}	Supply Voltage	1.2	4.0	V
T _A	Ambient Operating Temperature	-40	+85	°C

Electrical Characteristics

Unless otherwise noted, $V_{IN}=1.2$ to $4.0V$, $T_A=-40$ to $+85^{\circ}C$; typical values are at $V_{IN}=3.3V$ and $T_A=25^{\circ}C$.

Symbol	Parameter	Conditions	Min.	Typ.	Max.	Units
Basic Operation						
V_{IN}	Supply Voltage		1.2		4.0	V
$I_{Q(OFF)}$	Off Supply Current	$V_{ON}=GND$, $V_{OUT}=Open$, $V_{IN}=4V$			1	μA
$I_{SD(OFF)}$	Off Switch Current	$V_{ON}=GND$, $V_{OUT}=GND$			1	μA
I_Q	Quiescent Current	$I_{OUT}=0mA$, $V_{ON}=V_{IN}$			1	μA
		$I_{OUT}=0mA$, $V_{ON} < V_{IN}$			3	
R_{ON}	On-Resistance	$V_{IN}=3.3V$, $I_{OUT}=200mA$, $T_A=25^{\circ}C$		35	50	m Ω
		$V_{IN}=1.8V$, $I_{OUT}=200mA$, $T_A=25^{\circ}C$		55	70	
		$V_{IN}=1.5V$, $I_{OUT}=200mA$, $T_A=25^{\circ}C$		70		
		$V_{IN}=1.2V$, $I_{OUT}=200mA$, $T_A=25^{\circ}C$		85	150	
		$V_{IN}=1.8V$, $I_{OUT}=200mA$, $T_A=85^{\circ}C^{(3)}$		65	100	
R_{PD}	Output Discharge $R_{PULL\ DOWN}$	$V_{IN}=3.3V$, $V_{ON}=0V$, $I_{FORCE}=20mA$, $T_A=25^{\circ}C$, FPF1104		65	110	Ω
V_{IH}	ON Input Logic High Voltage	$V_{IN}=1.2V$ to $4.0V$	1.1			V
V_{IL}	ON Input Logic Low Voltage	$V_{IN}=1.2V$ to $4.0V$			0.35	V
I_{ON}	ON Input Leakage	$V_{ON}=V_{IN}$ or GND	-1		1	μA
Dynamic Characteristics						
t_{DON}	Turn-On Delay ⁽⁴⁾	$V_{IN}=3.3V$, $R_L=10\Omega$, $C_L=0.1\mu F$, $T_A=25^{\circ}C$		35		μs
t_R	V_{OUT} Rise Time ⁽⁴⁾			65		μs
t_{ON}	Turn-On Time ^(4,6)			100		μs
t_{DON}	Turn-On Delay ⁽⁴⁾	$V_{IN}=3.3V$, $R_L=500\Omega$, $C_L=0.1\mu F$, $T_A=25^{\circ}C$		30	50	μs
t_R	V_{OUT} Rise Time ⁽⁴⁾			40	55	μs
t_{ON}	Turn-On Time ^(4,6)			70	105	μs
FPF1103						
t_{DOFF}	Turn-Off Delay ⁽⁴⁾	$V_{IN}=3.3V$, $R_L=10\Omega$, $C_L=0.1\mu F$, $T_A=25^{\circ}C$		2.0	2.5	μs
t_F	V_{OUT} Fall Time ⁽⁴⁾			2.2		μs
t_{OFF}	Turn-Off ^(4,7)			4.2		μs
t_{DOFF}	Turn-Off Delay ⁽⁴⁾	$V_{IN}=3.3V$, $R_L=500\Omega$, $C_L=0.1\mu F$, $T_A=25^{\circ}C$		7.0		μs
t_F	V_{OUT} Fall Time ⁽⁴⁾			110		μs
t_{OFF}	Turn-Off ^(4,7)			117		μs
FPF1104⁽⁵⁾						
t_{DOFF}	Turn-Off Delay ⁽⁴⁾	$V_{IN}=3.3V$, $R_L=10\Omega$, $C_L=0.1\mu F$, $R_{PD}=65\Omega$, $T_A=25^{\circ}C$		2.0	2.5	μs
t_F	V_{OUT} Fall Time ⁽⁴⁾			1.9		μs
t_{OFF}	Turn-Off ^(4,7)			3.9		μs
t_{DOFF}	Turn-Off Delay ⁽⁴⁾	$V_{IN}=3.3V$, $R_L=500\Omega$, $C_L=0.1\mu F$, $R_{PD}=65\Omega$, $T_A=25^{\circ}C$		2.5		μs
t_F	V_{OUT} Fall Time ⁽⁴⁾			10.6		μs
t_{OFF}	Turn-Off ^(4,7)			13.1		μs

Notes:

- This parameter is guaranteed by design and characterization; not production tested.
- $t_{DON}/t_{DOFF}/t_R/t_F$ are defined in Figure 7.
- Output discharge path is enabled during off.

Timing Diagram

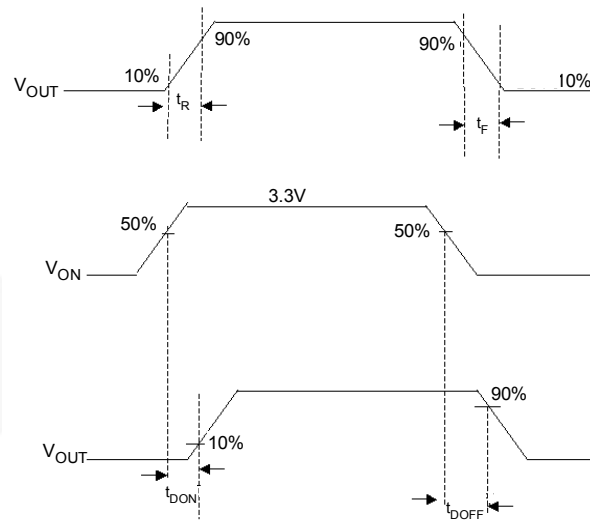

Notes:

6. $t_{ON} = t_R + t_{DON}$.
7. $t_{OFF} = t_F + t_{DOFF}$.

Figure 7. Timing Diagram



Typical Performance Characteristics

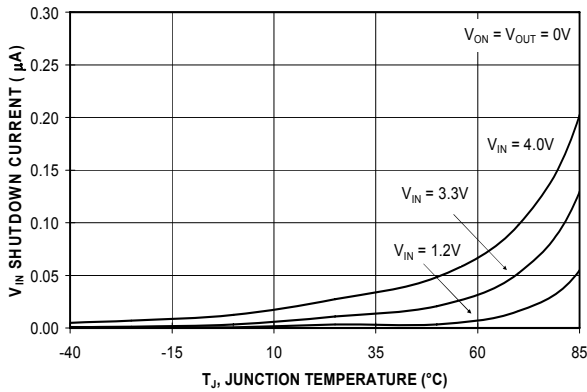

Figure 8. Shutdown Current vs. Temperature

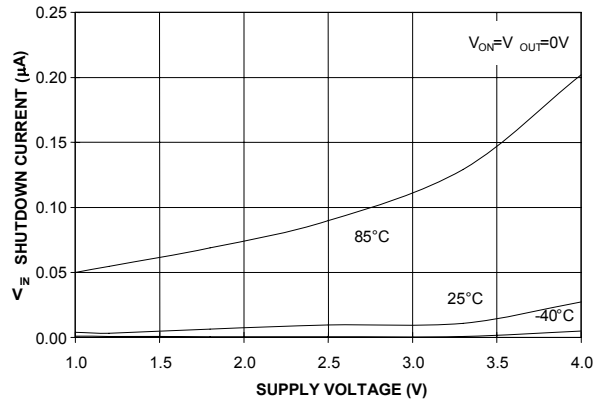

Figure 9. Shutdown Current vs. Supply Voltage

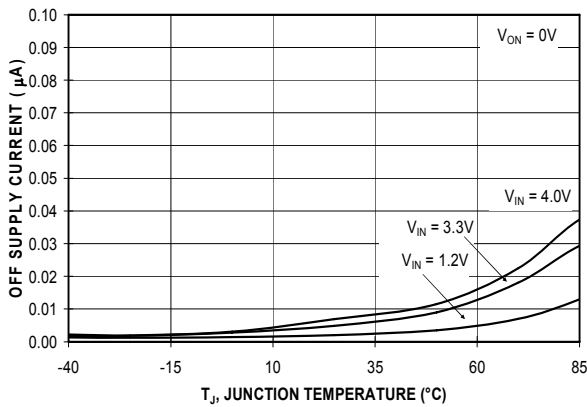

Figure 10. Off Supply Current vs. Temperature (FPF1103, V_{OUT} is floating)

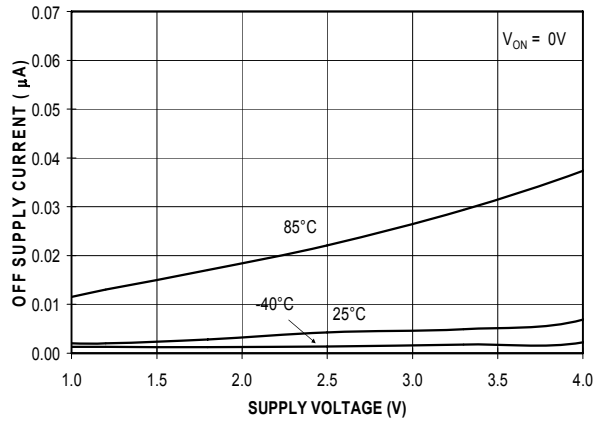

Figure 11. Off Supply Current vs. Supply Voltage (FPF1103, V_{OUT} is floating)

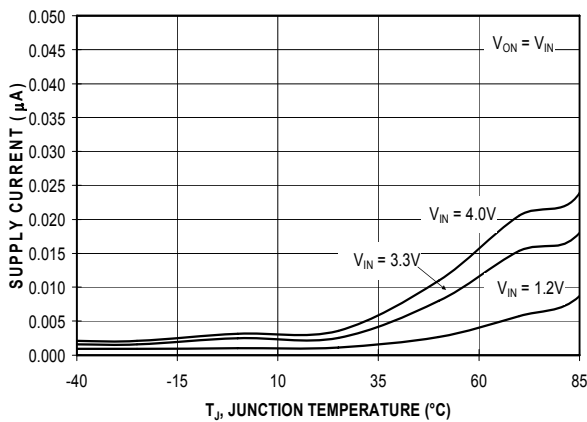

Figure 12. Quiescent Current vs. Temperature (V_{ON}=V_{IN})

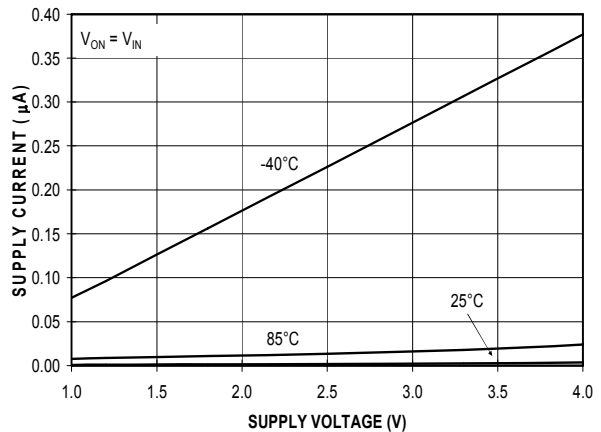

Figure 13. Quiescent Current vs. Supply Voltage

www.DataSheet4U.com

Typical Performance Characteristics

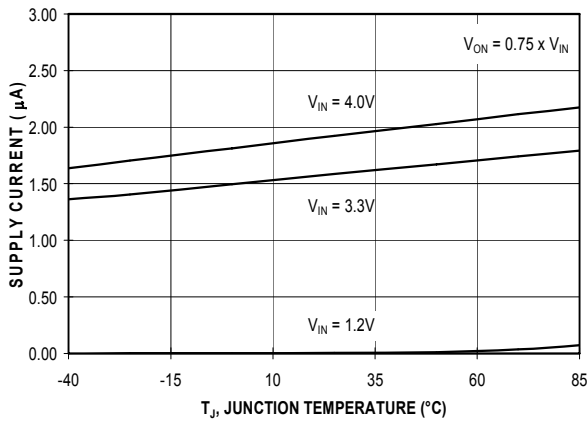

Figure 14. Quiescent Current vs. Temperature ($V_{ON}=0.75 \times V_{IN}$)

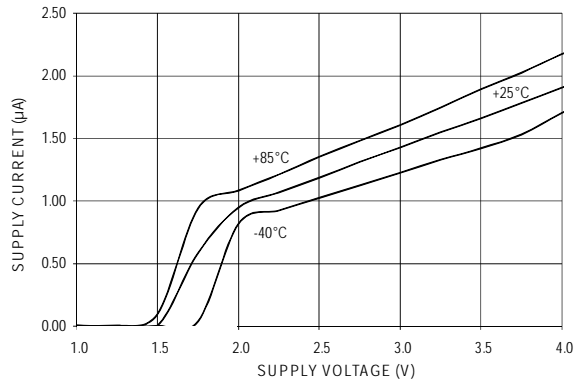

Figure 15. Quiescent Current vs. Supply Voltage at $V_{ON}=1.2V$

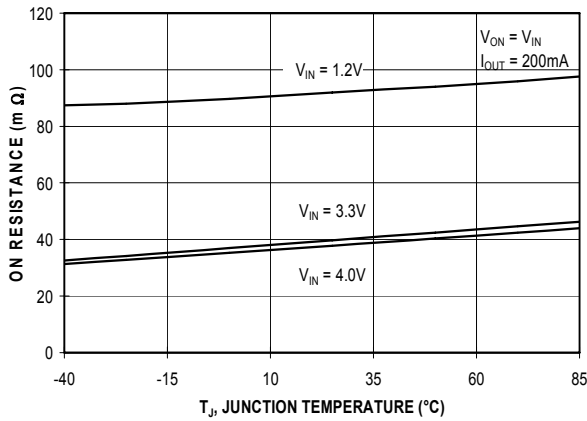

Figure 16. R_{ON} vs. Temperature

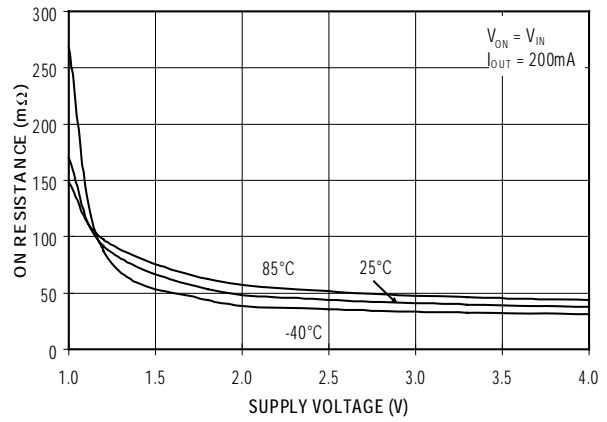

Figure 17. R_{ON} vs. Supply Voltage

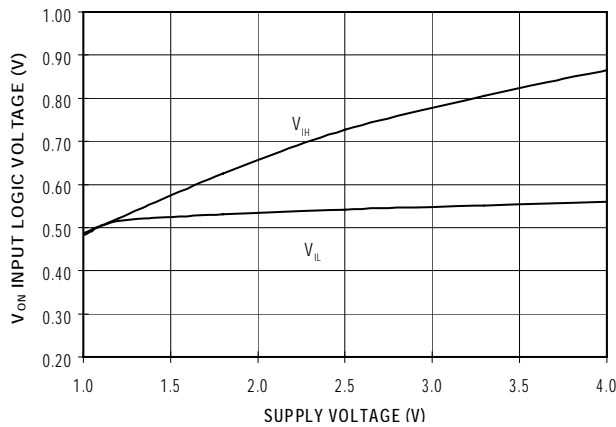

Figure 18. ON-Pin Threshold vs. V_{IN}

www.DataSheet4U.com

Typical Performance Characteristics

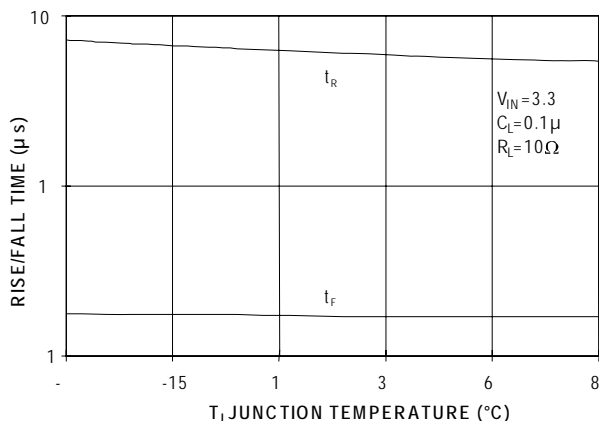

Figure 19. V_{OUT} Rise and Fall Time vs. Temperature at $R_L=10\Omega$

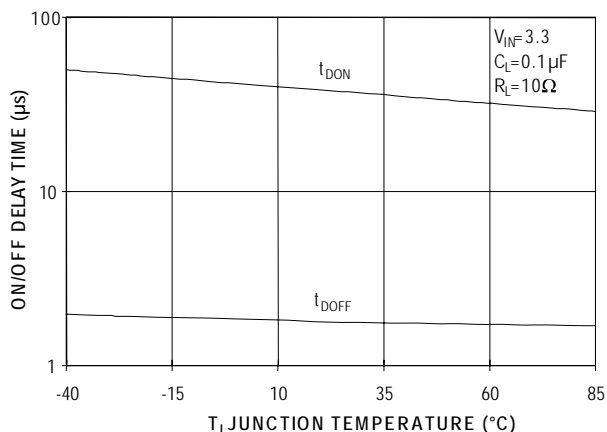

Figure 20. V_{OUT} Turn-On and Turn-Off Delay vs. Temperature at $R_L=10\Omega$

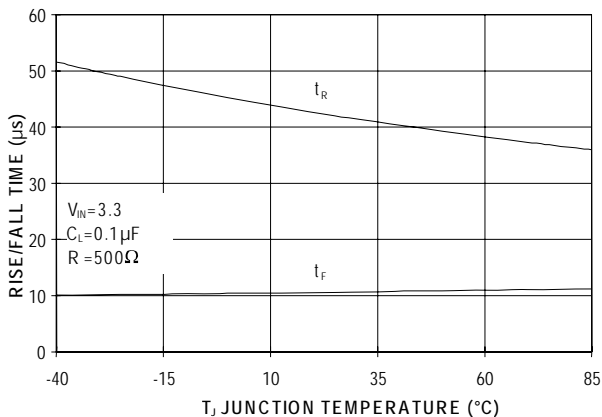

Figure 21. V_{OUT} Rise and Fall Time vs. Temperature at $R_L=500\Omega$

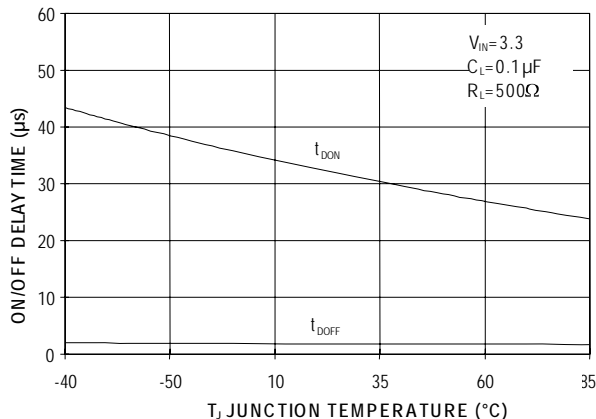

Figure 22. V_{OUT} Turn-On and Turn-Off Delay vs. Temperature at $R_L=500\Omega$

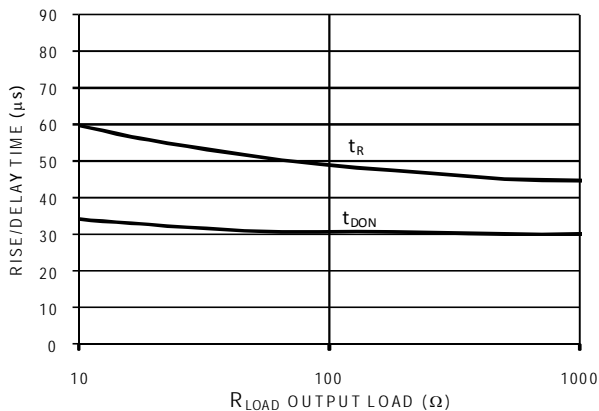

Figure 23. t_R/t_{DON} vs. Output Load at $V_{IN}=3.3V$

Typical Performance Characteristics

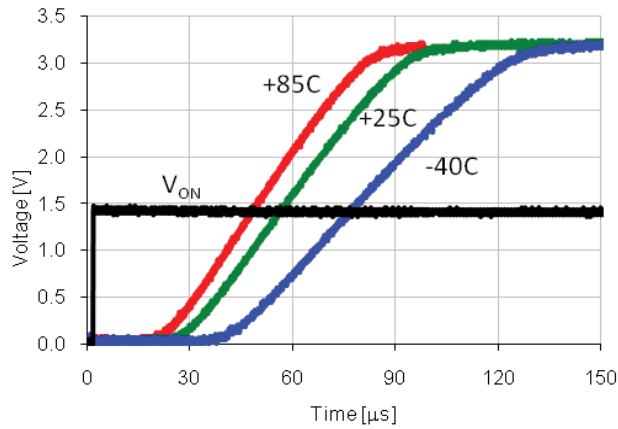

Figure 24. Turn-On Response
(V_{IN}=3.3V, C_{IN}=1μF, C_{OUT}=0.1μF, R_L=100Ω)

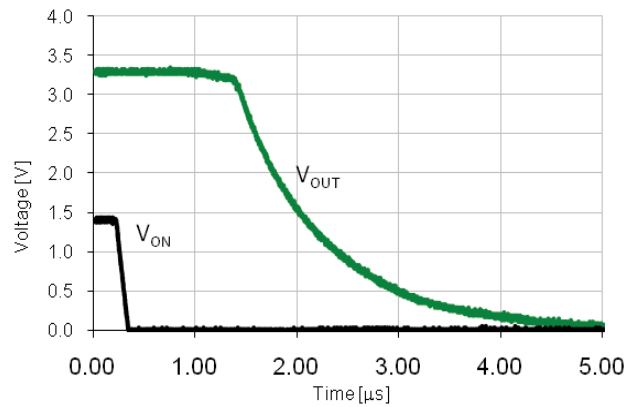

Figure 25. Turn-Off Response
(V_{IN}=3.3V, C_{IN}=1μF, C_{OUT}=0.1μF, R_L=100Ω)

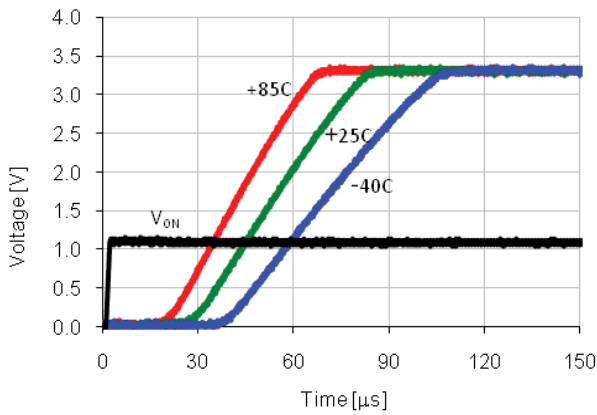

Figure 26. Turn-On Response
(V_{IN}=3.3V, C_{IN}=1μF, C_{OUT}=0.1μF, R_L=500Ω)

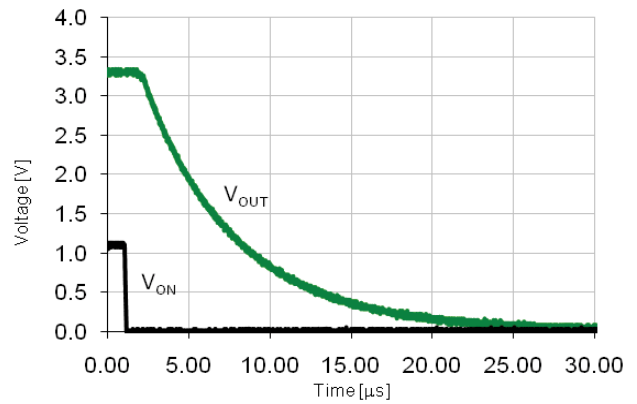

Figure 27. Turn-Off Response
(V_{IN}=3.3V, C_{IN}=1μF, C_{OUT}=0.1μF, R_L=500Ω)

www.DataSheet4U.com



Application Information

Input Capacitor

An IntelliMAX™ switch doesn't require an input capacitor. To reduce device inrush current effect, a 0.1μF ceramic capacitor, C_{IN}, is recommended close to the VIN pin. A higher value of C_{IN} can be used to further reduce the voltage drop experienced as the switch is turned on into a large capacitive load.

Output Capacitor

An IntelliMAX™ switch works without an output capacitor. However, if parasitic board inductance forces V_{OUT} below GND when switching off, a 0.1μF capacitor, C_{OUT}, should be placed between V_{OUT} and GND.

Fall Time

Device output fall time can be calculated based on RC constant of the external components as follows:

$$t_F = R_L \times C_L \times 2.2 \quad (1)$$

where t_F is 90% to 10% fall time, R_L is output load, and C_L is output capacitor.

The same equation works for a device with a pull-down output resistor. R_L is replaced by a parallel connected pull-down and an external output resistor combination, as follows:

$$t_F = \frac{R_L \times R_{PD}}{R_L + R_{PD}} \times C_L \times 2.2 \quad (2)$$

where t_F is 90% to 10% fall time, R_L is output load, R_{PD}=65Ω is output pull-down resistor, and C_L is the output capacitor.

Resistive Output Load

If resistive output load is missing, the IntelliMAX™ switch without a pull-down output resistor is not discharging the output voltage. Output voltage drop depends, in that case, mainly on external device leaks.

Recommended Land Pattern and Layout

For best thermal performance and minimal inductance and parasitic effects, it is recommended to keep input and output traces short and capacitors

as close to the device as possible. Below is a recommended layout for this device to achieve optimum performance.

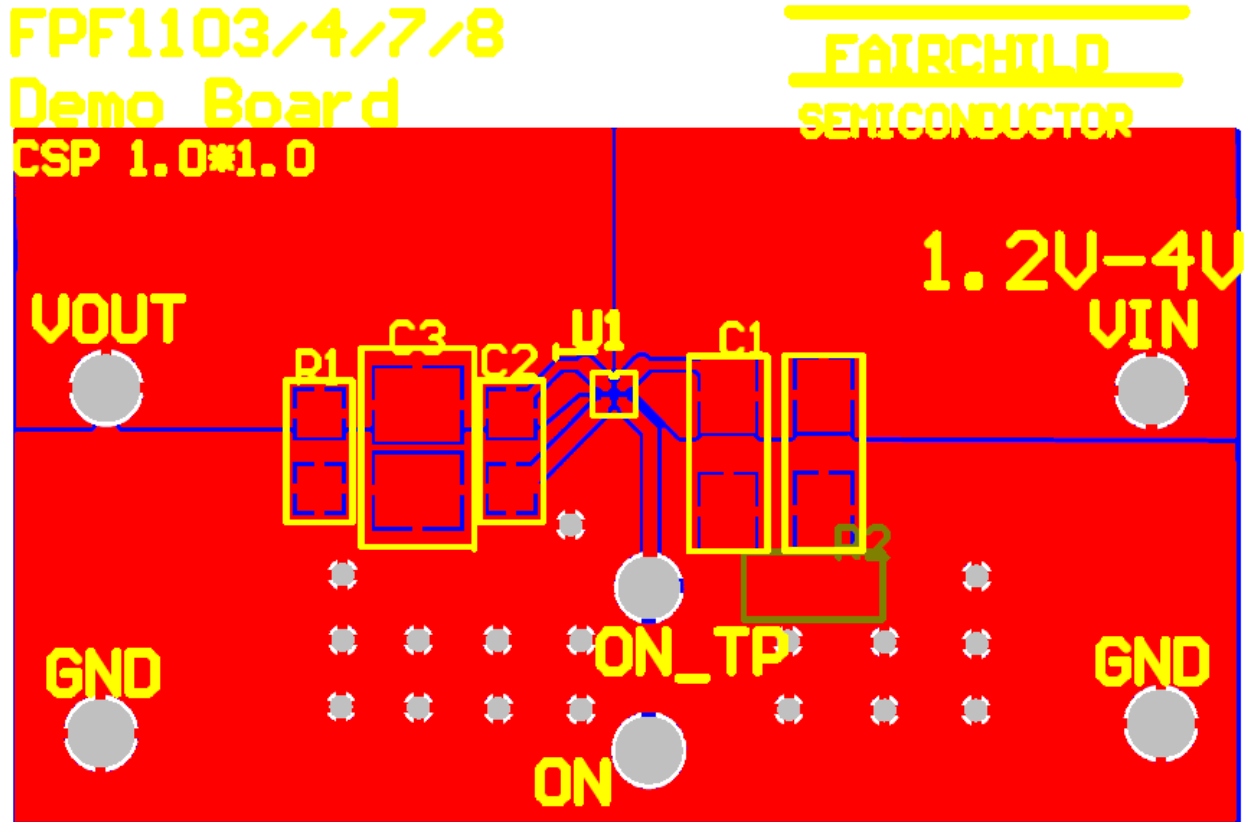
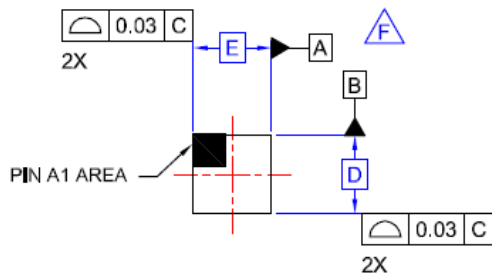

Figure 28. Recommended Land Pattern and Layout

www.DataSheet4U.com

Physical Dimensions



TOP VIEW

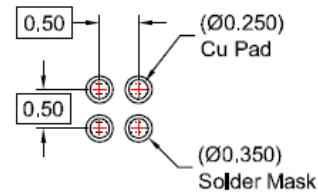

RECOMMENDED LAND PATTERN (NSMD PAD TYPE)

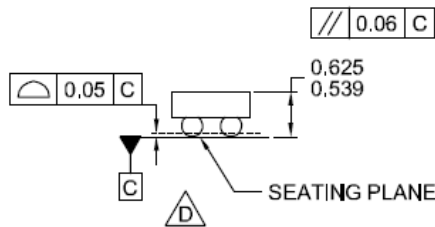

SIDE VIEWS

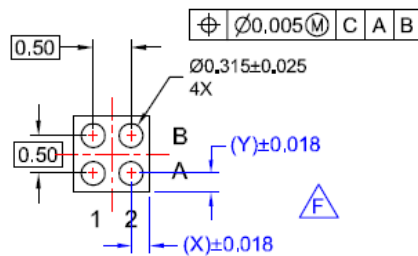
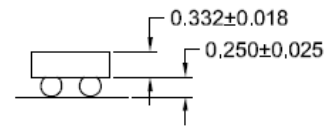

BOTTOM VIEW

NOTES:

- A. NO JEDEC REGISTRATION APPLIES.
- B. DIMENSIONS ARE IN MILLIMETERS.
- C. DIMENSIONS AND TOLERANCES PER ASME Y14.5M, 1994.
- D. DATUM C IS DEFINED BY THE SPHERICAL CROWNS OF THE BALLS.
- E. PACKAGE NOMINAL HEIGHT IS 582 MICRONS ±43 MICRONS (539-625 MICRONS).
- F. FOR DIMENSIONS D, E, X, AND Y SEE PRODUCT DATASHEET.
- G. DRAWING FILENAME: MKT-UC004ABrev2.

Figure 29.4 Ball, 1.0 x 1.0mm Wafer-Level Chip-Scale Packaging (WLCSP)

Product-Specific Dimensions

Product	D	E	X	Y
FPF1103	960µm ± 30µm	960µm ± 30µm	0.230mm	0.230mm
FPF1104	960µm ± 30µm	960µm ± 30µm	0.230mm	0.230mm

Package drawings are provided as a service to customers considering Fairchild components. Drawings may change in any manner without notice. Please note the revision and/or date on the drawing and contact a Fairchild Semiconductor representative to verify or obtain the most recent revision. Package specifications do not expand the terms of Fairchild's worldwide terms and conditions, specifically the warranty therein, which covers Fairchild products.

Always visit Fairchild Semiconductor's online packaging area for the most recent package drawings:
<http://www.fairchildsemi.com/packaging/>



TRADEMARKS

The following includes registered and unregistered trademarks and service marks, owned by Fairchild Semiconductor and/or its global subsidiaries, and is not intended to be an exhaustive list of all such trademarks.

AccuPower™	FlashWriter®*	Power-SPM™	<p>SYSTEM GENERAL® The Power Franchise®</p> <p>the power franchise</p> <p>TinyBoost™</p> <p>TinyBuck™</p> <p>TinyCalc™</p> <p>TinyLogic®</p> <p>TINYOPTO™</p> <p>TinyPower™</p> <p>TinyPWM™</p> <p>TinyWire™</p> <p>TriFault Detect™</p> <p>TRUECURRENT™*</p> <p>µSerDes™</p> <p>SerDes™</p> <p>UHC®</p> <p>Ultra FRFET™</p> <p>UniFET™</p> <p>VCM™</p> <p>VisualMax™</p> <p>XST™</p>
Auto-SPM™	FPS™	PowerTrench®	
Build it Now™	F-PFS™	PowerXST™	
CorePLUS™	FRFET®	Programmable Active Droop™	
CorePOWER™	Global Power Resource™	QFET®	
CROSSVOLT™	Green FPS™	QST™	
CTL™	Green FPS™ e-Series™	Quiet Series™	
Current Transfer Logic™	Gmax™	RapidConfigure™	
EcoSPARK®	GTO™	™	
EfficientMax™	IntelliMAX™	Saving our world, 1mW/W/kW at a time™	
EZSWITCH™*	ISOPLANAR™	SignalWise™	
™*	MegaBuck™	SmartMax™	
DEUXPEED™	MICROCOUPLER™	SMART START™	
™	MicroFET™	SPM®	
Fairchild®	MicroPak™	STEALTH™	
Fairchild Semiconductor®	MillerDrive™	SuperFET™	
FACT Quiet Series™	MotionMax™	SuperSOT™-3	
FACT®	Motion-SPM™	SuperSOT™-6	
FAST®	OPTOLOGIC®	SuperSOT™-8	
FastvCore™	OPTOPLANAR®	SupreMOS™	
FETBench™	™	SyncFET™	
		Sync-Lock™	

* Trademarks of System General Corporation, used under license by Fairchild Semiconductor.

DISCLAIMER

FAIRCHILD SEMICONDUCTOR RESERVES THE RIGHT TO MAKE CHANGES WITHOUT FURTHER NOTICE TO ANY PRODUCTS HEREIN TO IMPROVE RELIABILITY, FUNCTION, OR DESIGN. FAIRCHILD DOES NOT ASSUME ANY LIABILITY ARISING OUT OF THE APPLICATION OR USE OF ANY PRODUCT OR CIRCUIT DESCRIBED HEREIN; NEITHER DOES IT CONVEY ANY LICENSE UNDER ITS PATENT RIGHTS, NOR THE RIGHTS OF OTHERS. THESE SPECIFICATIONS DO NOT EXPAND THE TERMS OF FAIRCHILD'S WORLDWIDE TERMS AND CONDITIONS, SPECIFICALLY THE WARRANTY THEREIN, WHICH COVERS THESE PRODUCTS.

LIFE SUPPORT POLICY

FAIRCHILD'S PRODUCTS ARE NOT AUTHORIZED FOR USE AS CRITICAL COMPONENTS IN LIFE SUPPORT DEVICES OR SYSTEMS WITHOUT THE EXPRESS WRITTEN APPROVAL OF FAIRCHILD SEMICONDUCTOR CORPORATION.

As used herein:

- Life support devices or systems are devices or systems which, (a) are intended for surgical implant into the body or (b) support or sustain life, and (c) whose failure to perform when properly used in accordance with instructions for use provided in the labeling, can be reasonably expected to result in a significant injury of the user.
- A critical component in any component of a life support, device, or system whose failure to perform can be reasonably expected to cause the failure of the life support device or system, or to affect its safety or effectiveness.

ANTI-COUNTERFEITING POLICY

Fairchild Semiconductor Corporation's Anti-Counterfeiting Policy. Fairchild's Anti-Counterfeiting Policy is also stated on our external website, www.fairchildsemi.com, under Sales Support.

Counterfeiting of semiconductor parts is a growing problem in the industry. All manufacturers of semiconductor products are experiencing counterfeiting of their parts. Customers who inadvertently purchase counterfeit parts experience many problems such as loss of brand reputation, substandard performance, failed applications, and increased cost of production and manufacturing delays. Fairchild is taking strong measures to protect ourselves and our customers from the proliferation of counterfeit parts. Fairchild strongly encourages customers to purchase Fairchild parts either directly from Fairchild or from Authorized Fairchild Distributors who are listed by country on our web page cited above. Products customers buy either from Fairchild directly or from Authorized Fairchild Distributors are genuine parts, have full traceability, meet Fairchild's quality standards for handling and storage and provide access to Fairchild's full range of up-to-date technical and product information. Fairchild and our Authorized Distributors will stand behind all warranties and will appropriately address any warranty issues that may arise. Fairchild will not provide any warranty coverage or other assistance for parts bought from Unauthorized Sources. Fairchild is committed to combat this global problem and encourage our customers to do their part in stopping this practice by buying direct or from authorized distributors.

PRODUCT STATUS DEFINITIONS

Definition of Terms

Datasheet Identification	Product Status	Definition
Advance Information	Formative / In Design	Datasheet contains the design specifications for product development. Specifications may change in any manner without notice.
Preliminary	First Production	Datasheet contains preliminary data; supplementary data will be published at a later date. Fairchild Semiconductor reserves the right to make changes at any time without notice to improve design.
No Identification Needed	Full Production	Datasheet contains final specifications. Fairchild Semiconductor reserves the right to make changes at any time without notice to improve the design.
Obsolete	Not In Production	Datasheet contains specifications on a product that is discontinued by Fairchild Semiconductor. The datasheet is for reference information only.

Rev. I43