



August 2000

QFET™

FQS4900

Dual N & P-Channel, Logic Level MOSFET

General Description

These dual N and P-channel enhancement mode power field effect transistors are produced using Fairchild's proprietary, planar stripe, DMOS technology. This advanced technology has been especially tailored to minimize on-state resistance, provide superior switching performance, and withstand high energy pulse in the avalanche and commutation mode. This device is well suited for high interface in telephone sets.

Features

- N-Channel 1.3A, 60V, $R_{DS(on)} = 0.55 \Omega @ V_{GS} = 10 V$
 $R_{DS(on)} = 0.65 \Omega @ V_{GS} = 5 V$
- P-Channel -0.3A, -300V, $R_{DS(on)} = 15.5 \Omega @ V_{GS} = -10 V$
 $R_{DS(on)} = 16 \Omega @ V_{GS} = -5 V$
- Low gate charge (typical N-Channel 1.6 nC)
 (typical P-Channel 3.6 nC)
- Fast switching
- Improved dv/dt capability

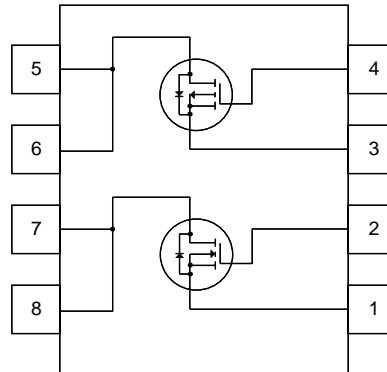
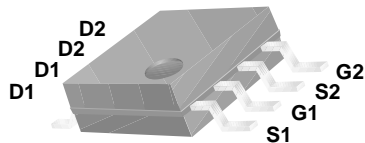

Absolute Maximum Ratings $T_A = 25^\circ C$ unless otherwise noted

Symbol	Parameter	N-Channel	P-Channel	Units
V_{DSS}	Drain-Source Voltage	60	-300	V
I_D	Drain Current - Continuous ($T_A = 25^\circ C$) - Continuous ($T_A = 70^\circ C$)	1.3	-0.3	A
		0.82	-0.19	A
I_{DM}	Drain Current - Pulsed (Note 1)	5.2	-1.2	A
V_{GSS}	Gate-Source Voltage	± 20		V
dv/dt	Peak Diode Recovery dv/dt (Note 2)	7.0	4.5	V/ns
P_D	Power Dissipation ($T_A = 25^\circ C$) ($T_A = 70^\circ C$)	2.0		W
		1.3		W
T_J, T_{STG}	Operating and Storage Temperature Range	-55 to +150		$^\circ C$

Thermal Characteristics

Symbol	Parameter	Typ	Max	Units
$R_{\theta JA}$	Thermal Resistance, Junction-to-Ambient	--	62.5	$^\circ C/W$

Electrical Characteristics T_A = 25°C unless otherwise noted

Symbol	Parameter	Test Conditions	Type	Min	Typ	Max	Units
Off Characteristics							
BV _{DSS}	Drain-Source Breakdown Voltage	V _{GS} = 0 V, I _D = 250 μA	N-Ch	60	--	--	V
		V _{GS} = 0 V, I _D = -250 μA	P-Ch	-300	--	--	V
I _{DSS}	Zero Gate Voltage Drain Current	V _{DS} = 60 V, V _{GS} = 0 V	N-Ch	--	--	1	μA
		V _{DS} = 48 V, T _C = 55°C		--	--	10	μA
		V _{DS} = -300 V, V _{GS} = 0 V	P-Ch	--	--	-1	μA
		V _{DS} = -240 V, T _C = 55°C		--	--	-10	μA
I _{GSSF}	Gate-Body Leakage Current, Forward	V _{GS} = 20 V, V _{DS} = 0 V	All	--	--	100	nA
I _{GSSR}	Gate-Body Leakage Current, Reverse	V _{GS} = -20 V, V _{DS} = 0 V	All	--	--	-100	nA

On Characteristics

V _{GS(th)}	Gate Threshold Voltage	V _{DS} = 4V, I _D = 20 mA	N-Ch	1.0	--	1.95	V
		V _{DS} = 4V, I _D = -20 mA	P-Ch	-1.0	--	-1.95	V
R _{DS(on)}	Static Drain-Source On-Resistance	V _{GS} = 10 V, I _D = 0.65 A	N-Ch	--	0.39	0.55	Ω
		V _{GS} = 5 V, I _D = 0.65 A		--	0.46	0.65	Ω
		V _{GS} = -10 V, I _D = -0.15 A	P-CH	--	11.2	15.5	Ω
		V _{GS} = -5 V, I _D = -0.15 A		--	11.4	16	Ω
g _{FS}	Forward Transconductance	V _{DS} = 10 V, I _D = 0.65 A	N-CH	--	1.7	--	S
		V _{DS} = -10 V, I _D = -0.15 A	P-CH	--	0.6	--	S

Switching Characteristics

t _{d(on)}	Turn-On Delay Time	N-Channel V _{DD} = 30 V, I _D = 1.3 A, R _G = 25 Ω	N-Ch	--	5.7	21	ns
			P-Ch	--	10	30	ns
t _r	Turn-On Rise Time	P-Channel V _{DD} = -150 V, I _D = -0.3 A, R _G = 25 Ω	N-Ch	--	21	50	ns
			P-Ch	--	25	60	ns
t _{d(off)}	Turn-Off Delay Time	N-Channel V _{DD} = -150 V, I _D = -0.3 A, R _G = 25 Ω	N-Ch	--	11	32	ns
			P-Ch	--	35	80	ns
t _f	Turn-Off Fall Time	P-Channel V _{DD} = -150 V, I _D = -0.3 A, R _G = 25 Ω	N-Ch	--	17	45	ns
			P-Ch	--	47	105	ns
Q _g	Total Gate Charge	N-Channel V _{DS} = 48 V, I _D = 1.3 A,	N-Ch	--	1.6	2.1	nC
			P-Ch	--	3.6	4.7	nC
Q _{gs}	Gate-Source Charge	V _{GS} = 5 V	N-Ch	--	0.28	--	nC
			P-Ch	--	0.42	--	nC
Q _{gd}	Gate-Drain Charge	V _{DS} = -240 V, I _D = -0.3 A, V _{GS} = -5 V	N-Ch	--	0.82	--	nC
			P-Ch	--	2.1	--	nC

Drain-Source Diode Characteristics and Maximum Ratings

I _S	Maximum Continuous Drain-Source Diode Forward Current	N-Ch	--	--	1.3	A	
		P-Ch	--	--	-0.3	A	
V _{SD}	Drain-Source Diode Forward Voltage	V _{GS} = 0 V, I _S = 1.3 A	N-Ch	--	--	1.5	V
		V _{GS} = 0 V, I _S = -0.3 A	P-Ch	--	--	-4.0	V

Notes:

1. Repetitive Rating : Pulse width limited by maximum junction temperature
3. Pulse Test : Pulse width ≤ 300μs, Duty cycle ≤ 2%
4. Essentially independent of operating temperature

Typical Characteristics : N-Channel

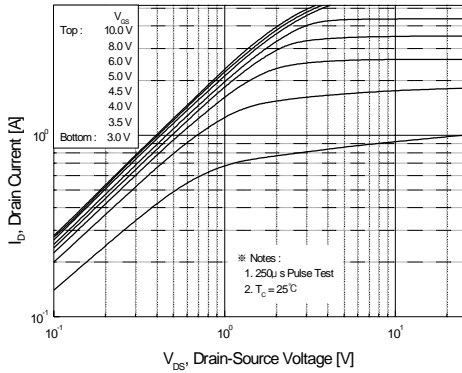

Figure 1. On-Region Characteristics

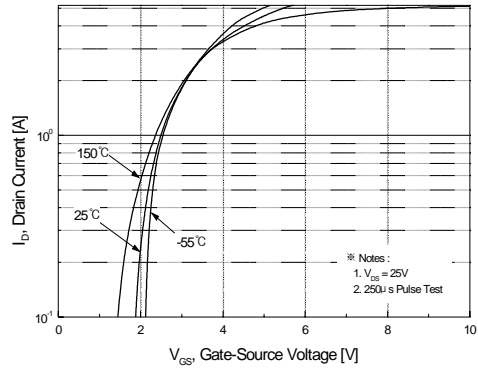

Figure 2. Transfer Characteristics

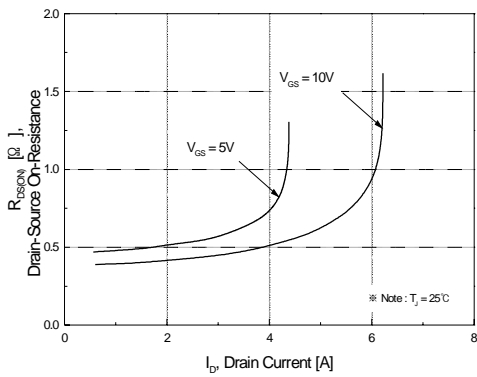

Figure 3. On-Resistance Variation vs. Drain Current and Gate Voltage

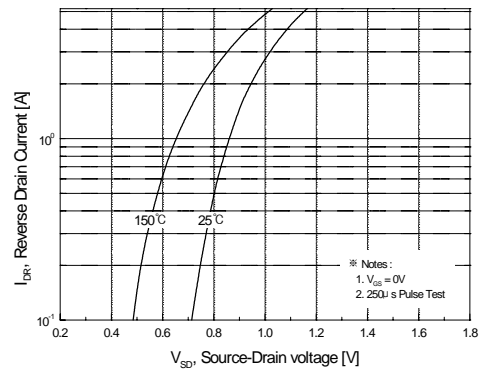

Figure 4. Body Diode Forward Voltage Variation vs. Source Current and Temperature

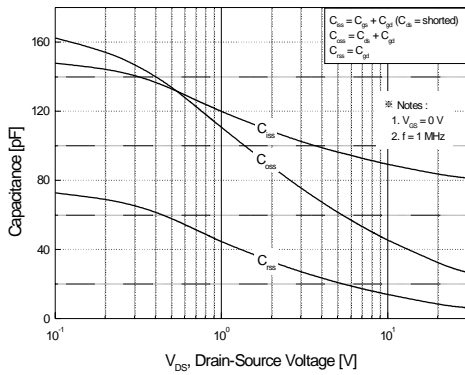

Figure 5. Capacitance Characteristics

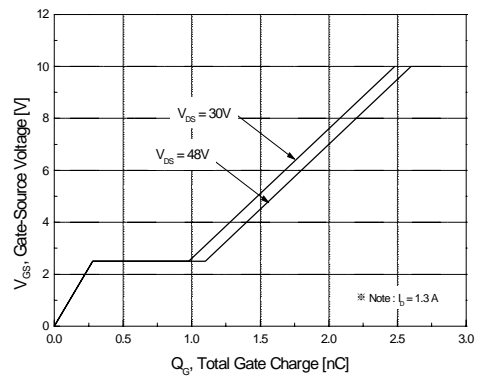

Figure 6. Gate Charge Characteristics

Typical Characteristics : N-Channel (Continued)

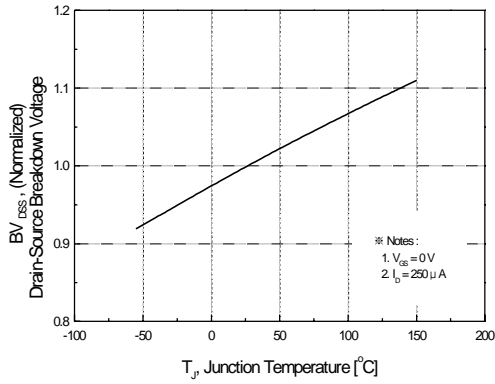

Figure 7. Breakdown Voltage Variation vs. Temperature

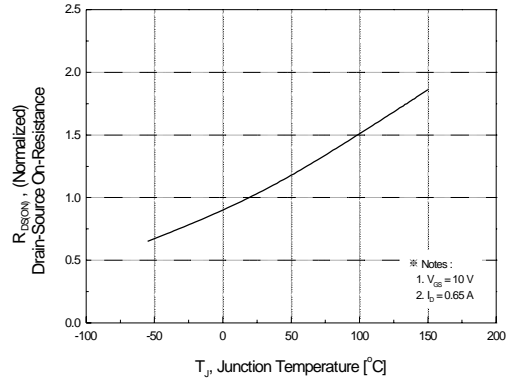

Figure 8. On-Resistance Variation vs. Temperature

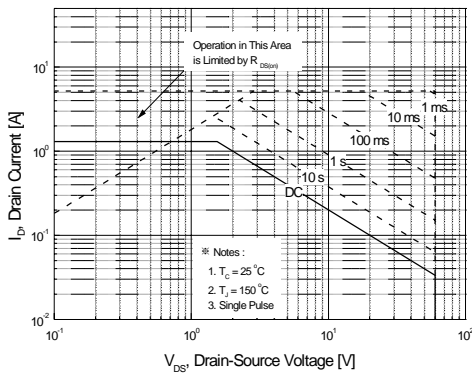

Figure 9. Maximum Safe Operating Area

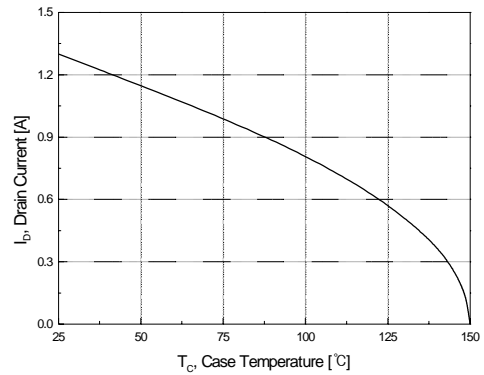

Figure 10. Maximum Drain Current vs. Case Temperature

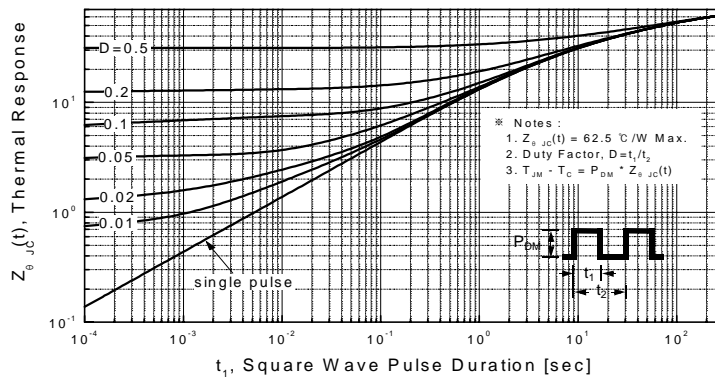

Figure 11. Transient Thermal Response Curve

Typical Characteristics : P-Channel (Continued)

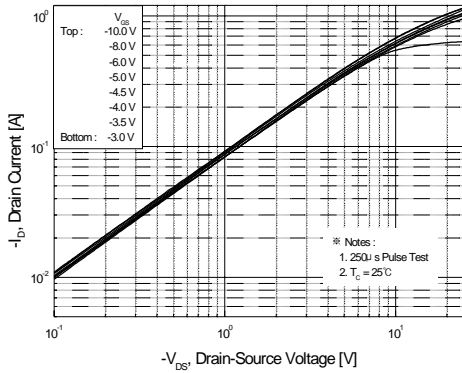

Figure 1. On-Region Characteristics

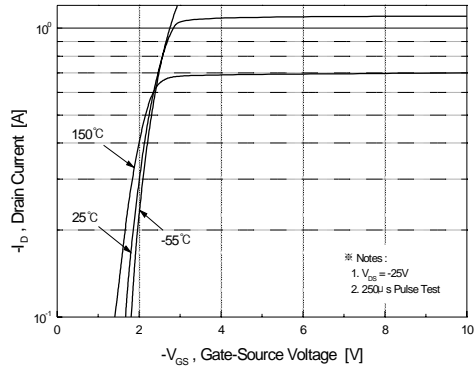

Figure 2. Transfer Characteristics

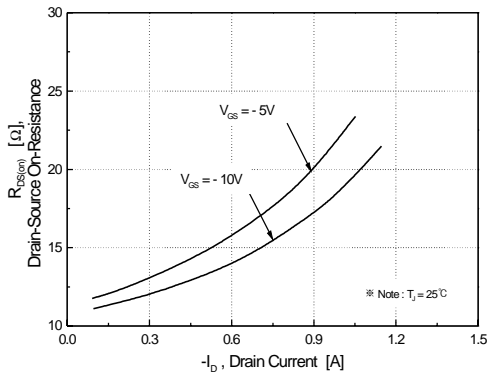

Figure 3. On-Resistance Variation vs. Drain Current and Gate Voltage

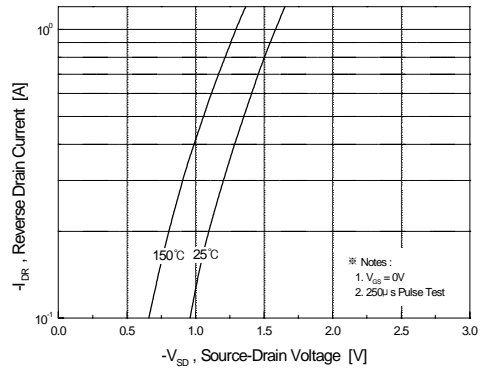

Figure 4. Body Diode Forward Voltage Variation vs. Source Current and Temperature

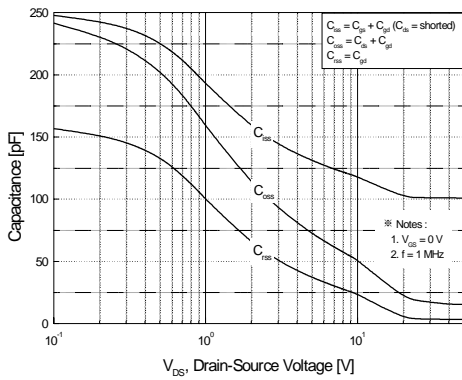

Figure 5. Capacitance Characteristics

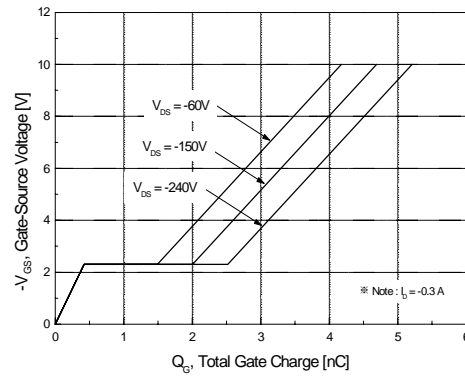

Figure 6. Gate Charge Characteristics

Typical Characteristics : P-Channel (Continued)

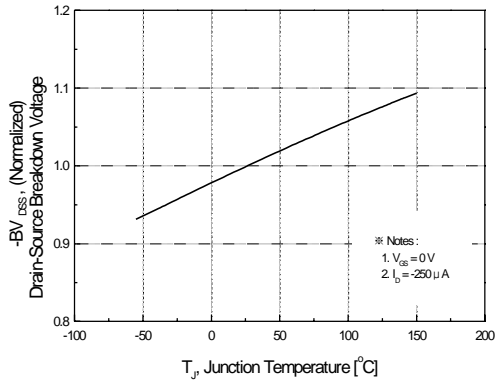

Figure 7. Breakdown Voltage Variation vs. Temperature

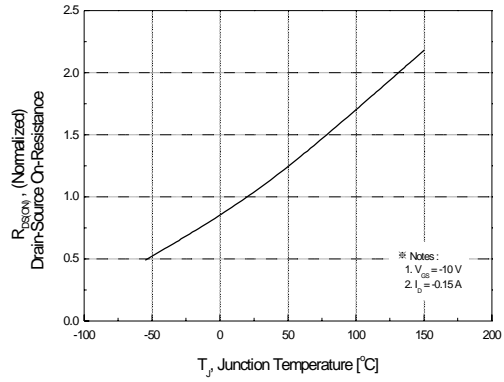

Figure 8. On-Resistance Variation vs. Temperature

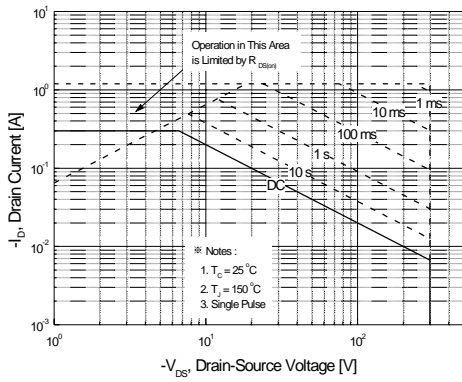

Figure 9. Maximum Safe Operating Area

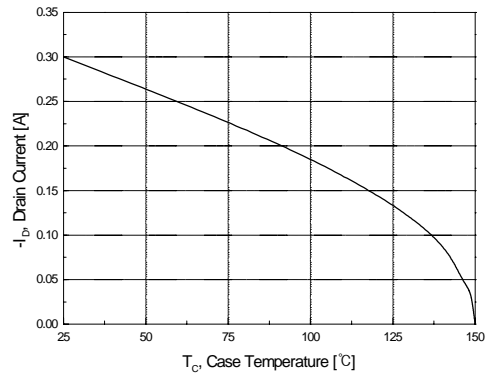

Figure 10. Maximum Drain Current vs. Case Temperature

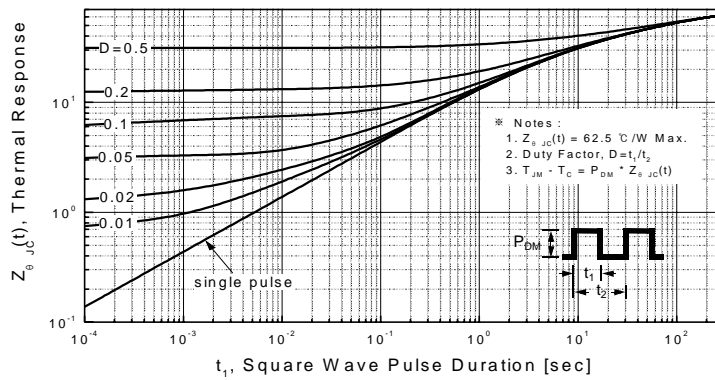
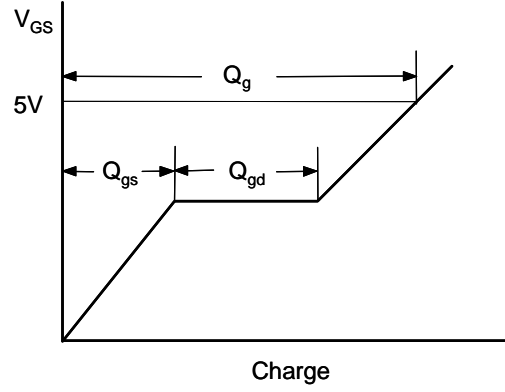
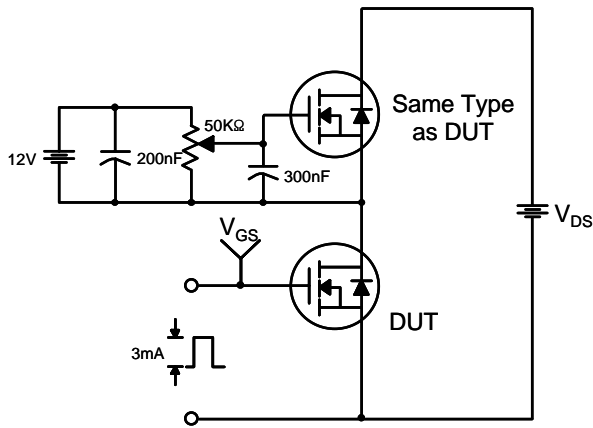
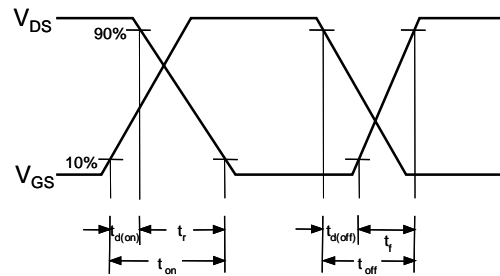
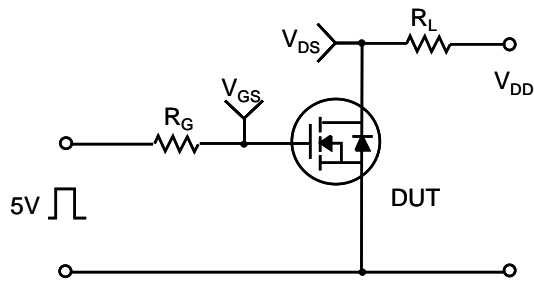

Figure 11. Transient Thermal Response Curve

Gate Charge Test Circuit & Waveform



Resistive Switching Test Circuit & Waveforms



Package Dimensions

8-SOP

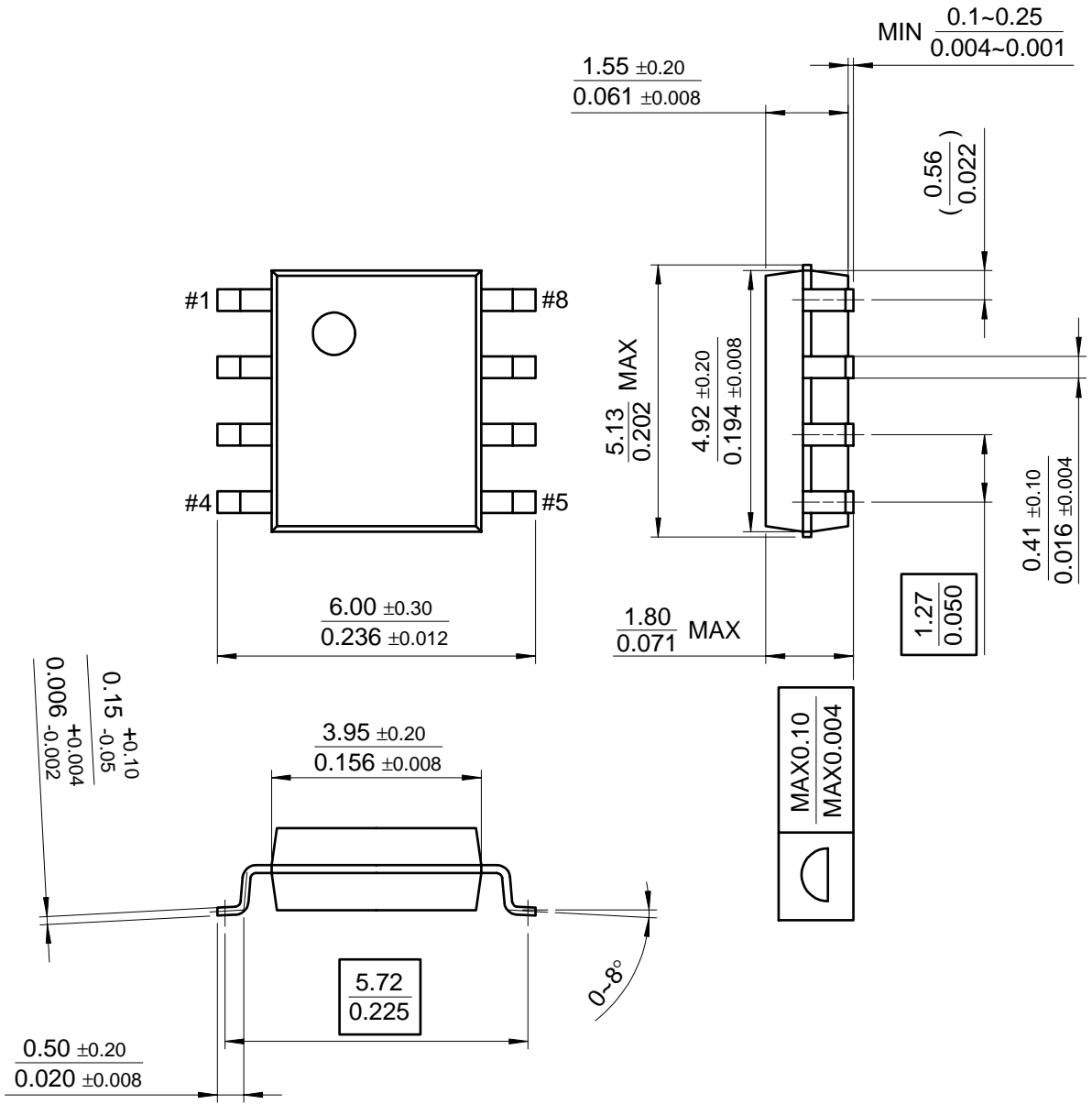

TRADEMARKS

The following are registered and unregistered trademarks Fairchild Semiconductor owns or is authorized to use and is not intended to be an exhaustive list of all such trademarks.

ACE _x TM	HiSeC TM	SuperSOT TM -8
Bottomless TM	ISOPLANAR TM	SyncFET TM
CoolFET TM	MICROWIRE TM	TinyLogic TM
CROSSVOLT TM	POP TM	UHC TM
E ² CMOS TM	PowerTrench [®]	VCX TM
FACT TM	QFET TM	
FACT Quiet Series TM	QS TM	
FAST [®]	Quiet Series TM	
FAST _r TM	SuperSOT TM -3	
GTO TM	SuperSOT TM -6	

DISCLAIMER

FAIRCHILD SEMICONDUCTOR RESERVES THE RIGHT TO MAKE CHANGES WITHOUT FURTHER NOTICE TO ANY PRODUCTS HEREIN TO IMPROVE RELIABILITY, FUNCTION OR DESIGN. FAIRCHILD DOES NOT ASSUME ANY LIABILITY ARISING OUT OF THE APPLICATION OR USE OF ANY PRODUCT OR CIRCUIT DESCRIBED HEREIN; NEITHER DOES IT CONVEY ANY LICENSE UNDER ITS PATENT RIGHTS, NOR THE RIGHTS OF OTHERS.

LIFE SUPPORT POLICY

FAIRCHILD'S PRODUCTS ARE NOT AUTHORIZED FOR USE AS CRITICAL COMPONENTS IN LIFE SUPPORT DEVICES OR SYSTEMS WITHOUT THE EXPRESS WRITTEN APPROVAL OF FAIRCHILD SEMICONDUCTOR INTERNATIONAL.

As used herein:

1. Life support devices or systems are devices or systems which, (a) are intended for surgical implant into the body, or (b) support or sustain life, or (c) whose failure to perform when properly used in accordance with instructions for use provided in the labeling, can be reasonably expected to result in significant injury to the user.
2. A critical component is any component of a life support device or system whose failure to perform can be reasonably expected to cause the failure of the life support device or system, or to affect its safety or effectiveness.

PRODUCT STATUS DEFINITIONS

Definition of Terms

Datasheet Identification	Product Status	Definition
Advance Information	Formative or In Design	This datasheet contains the design specifications for product development. Specifications may change in any manner without notice.
Preliminary	First Production	This datasheet contains preliminary data, and supplementary data will be published at a later date. Fairchild Semiconductor reserves the right to make changes at any time without notice in order to improve design.
No Identification Needed	Full Production	This datasheet contains final specifications. Fairchild Semiconductor reserves the right to make changes at any time without notice in order to improve design.
Obsolete	Not In Production	This datasheet contains specifications on a product that has been discontinued by Fairchild semiconductor. The datasheet is printed for reference information only.