

LOW DROP FIXED AND ADJUSTABLE POSITIVE VOLTAGE REGULATOR

The FR1117Series is a Low Drop Voltage Regulator able to provide up to 1A of output current, available even in adjustable version ($V_{ref}=1.25V$)

FEATURES

- Low Dropout Voltage : 1.2V/Typ. ($I_{out}=1.0A$)
- Very Low Quiescent Current : 4.2 mA/Typ.
- Output Current up to 1A
- Fixed Output Voltage of 1.2V, 1.25V, 1.5V, 1.8V, 2.5V, 3.3V, 5.0V
- Adjustable Version Availability : $V_{ref}=1.25V$
- Internal Current and Thermal Limit
- Only 10 μF for stability
- Available in $\pm 2\%$ (at 25°C) and 4% in full Temperature range
- High Ripple Rejection : 80dB/Typ
- Temperature Range (T_j) : -40°C ~ 125°C (for FR1117X-1.2 :0°C ~ 125°C)

LINE UP

ITEM	OUTPUT VOLTAGE (V)	PACKAGE
FR1117P/S/D/F-AD	Adjustable	F : SOT-89 S : SOT-223 D : D-PAK P : TO-220
FR1117P/S/D/F-1.2	1.2	
FR1117P/S/D/F-1.5	1.5	
FR1117P/S/D/F-1.8	1.8	
FR1117P/S/D/F-2.5	2.5	
FR1117P/S/D/F-3.3	3.3	
FR1117P/S/D/F-5.0	5.0	

MAXIMUM RATINGS ($T_a=25^\circ C$)

CHARACTERISTIC	SYMBOL	RATING	UNIT
Input Voltage	V_{IN}	15	V
Output Current	I_{OUT}	1.0	A
Thermal Resistance (R_{thj-c}) Note1.	F	100	$^\circ C/W$
	S	15	$^\circ C/W$
	D	8	$^\circ C/W$
	P	3	$^\circ C/W$
Operating Temperature	$T_{opr}(T_j)$	-40 ~ 125	$^\circ C$
Storage Temperature	T_{stg}	-55 ~ 150	$^\circ C$

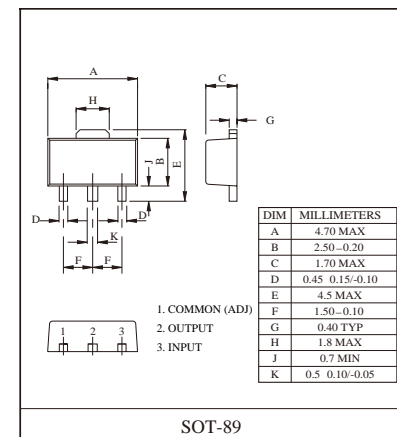
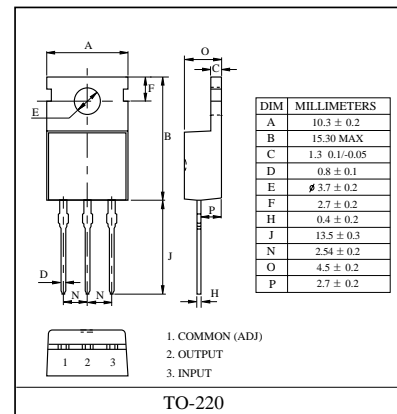
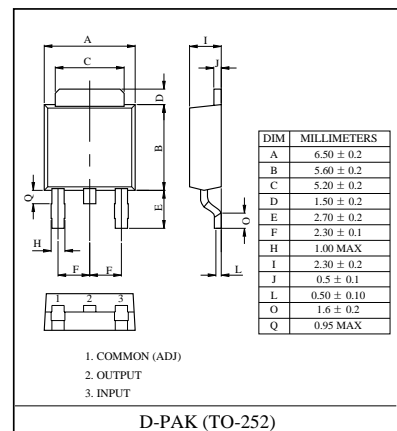
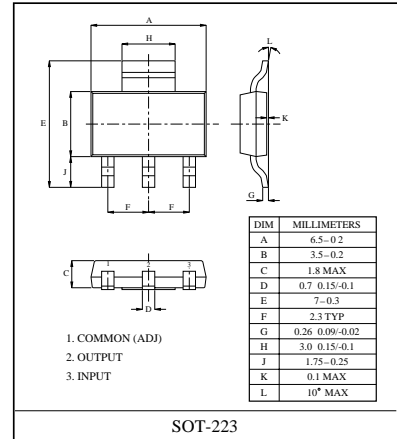

Note1 : Devices mounted on FR-4 substrate, single sided PC board, 2oz copper, with 5mm x 5mm thermal pad layout, no air flow. The case point of θ_{JC} is located on the thermal tab.



FR1117P/S/D/F-AD ~ FR1117P/S/D/F-5.0

ELECTRICAL CHARACTERISTICS

FR1117 (Unless otherwise specified, T_j= -40 ~ 125°C)

CHARACTERISTIC		SYMBOL	TEST CONDITIONS	MIN.	TYP.	MAX.	UNIT
Output Voltage	1.2	V _{OUT}	10mA ≤ I _{OUT} ≤ 1A, V _{OUT} +1.5V ≤ V _{IN} ≤ 10V	1.176	1.200	1.224	V
	1.25(AD)			1.225	1.250	1.280	
	1.5			1.470	1.500	1.530	
	1.8			1.764	1.800	1.836	
	2.5			2.450	2.500	2.550	
	3.3			3.240	3.300	3.360	
	5.0			4.900	5.000	5.100	
Line Regulation	1.2	Reg Line	V _{OUT} +1.5V ≤ V _{IN} ≤ 10V, I _{OUT} =10mA	-	2.0	7.0	mV
	1.25(AD)			-	0.1	0.2	%
	1.5			-	2.0	7.0	mV
	1.8			-	2.0	7.0	
	2.5			-	2.0	7.0	
	3.3			-	3.0	7.0	
	5.0			-	4.0	10.0	
Load Regulation	1.2	Reg Load	10mA ≤ I _{OUT} ≤ 1A, V _{IN} =V _{OUT} +2.0V	-	3.0	10.0	mV
	1.25(AD)			-	0.2	0.4	%
	1.5			-	3.0	10.0	mV
	1.8			-	3.0	10.0	
	2.5			-	3.0	10.0	
	3.3			-	4.0	12.0	
	5.0			-	5.0	15.0	
Quiescent Current		I _B	V _{IN} =V _{OUT} +1.5V, I _{OUT} =0A	-	5.2	10	mA
Adjustable Pin Current		I _{Adj}	V _{IN} =V _{OUT} +1.5V	-	50	120	μA
Output Noise Voltage		V _{NO}	V _{IN} =V _{OUT} +1.25V, I _{OUT} =40mA, 10Hz ≤ f ≤ 10kHz	-	100	-	μVrms
Short Circuit Current Limit		I _{SC}	V _{IN} =V _{OUT} +1.5V	1.0	1.25	2.2	A
Ripple Rejection		R · R	I _{OUT} =1A, f=120Hz, V _{ripple} =1Vp-p V _{IN} =V _{OUT} +5V	60	72	-	dB
Dropout Voltage		V _D	I _{OUT} =1A, V _{IN} =0.95V _{OUT}	-	1.2	1.4	V
Temperature Stability		TCV _O	V _{IN} =V _{OUT} +1.5V, I _{OUT} =10mA	-	0.5	-	%

Fig.1 Application Circuit-1 (Fixed-Type)

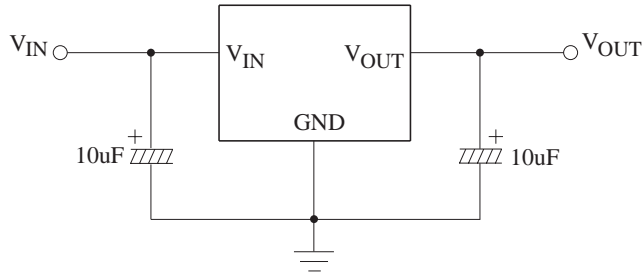
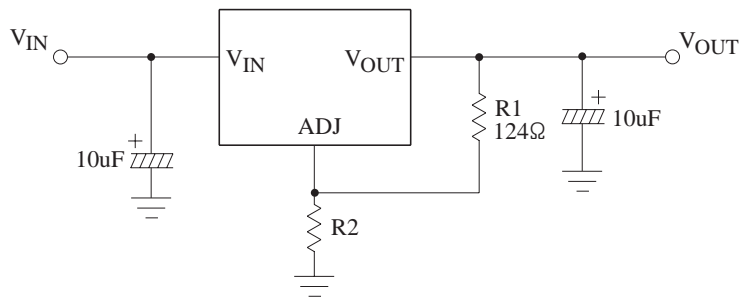
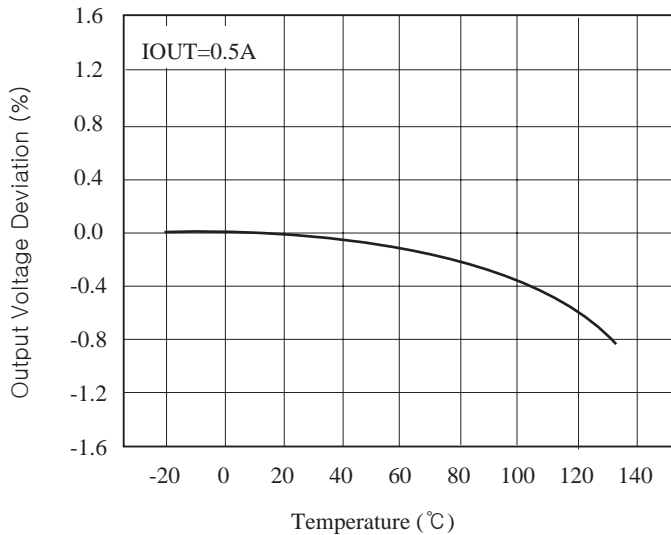

Fig.2 Application Circuit-2 (Adjustable-Type)



$$V_{OUT} = V_{REF} (1 + R2/R1) + I_{ADJ} \cdot R2$$

Temperature Stability



Ripple Rejection (with C_{adj} 25uF)

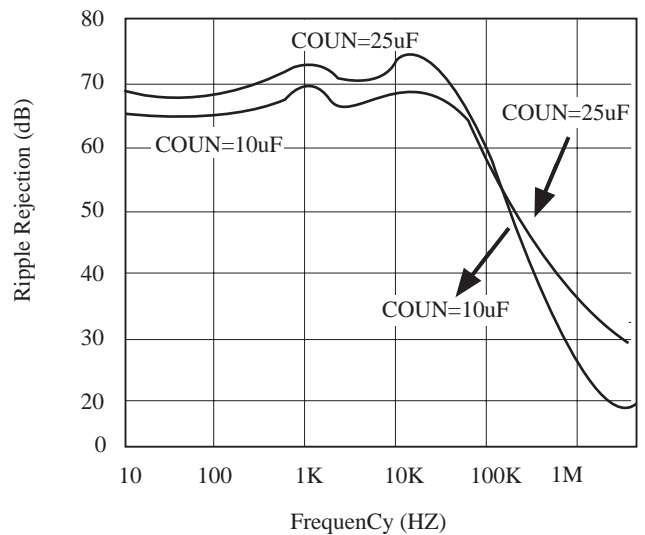



FR1117P/S/D/F-AD ~ FR1117P/S/D/F-5.0

Minimum Load Current (Adjustable)

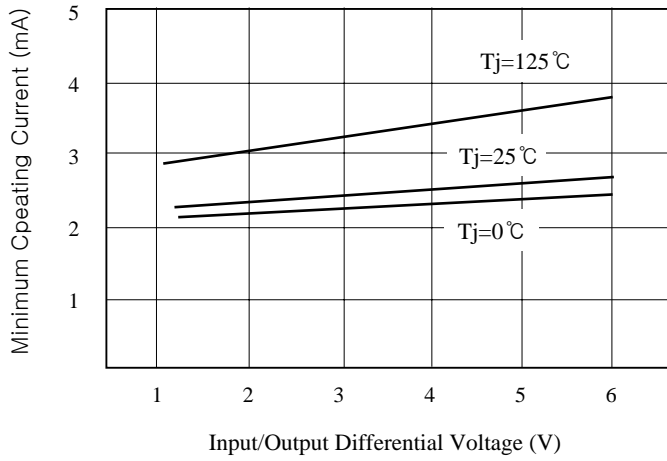

Adjust Pin Current

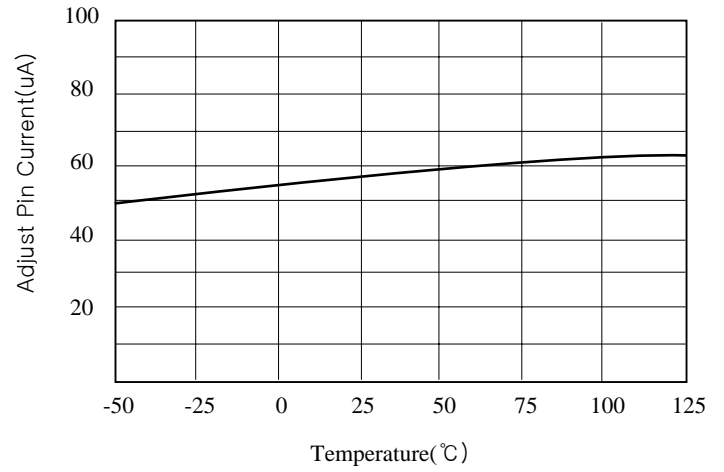

Dropout Voltage

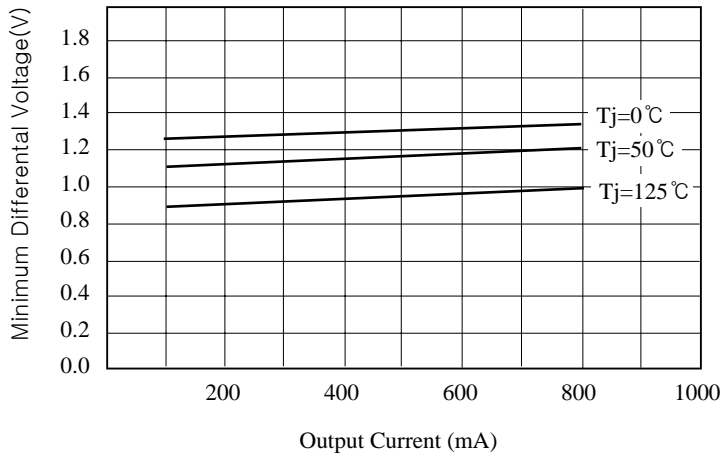

Dropout Voltage - Temperature

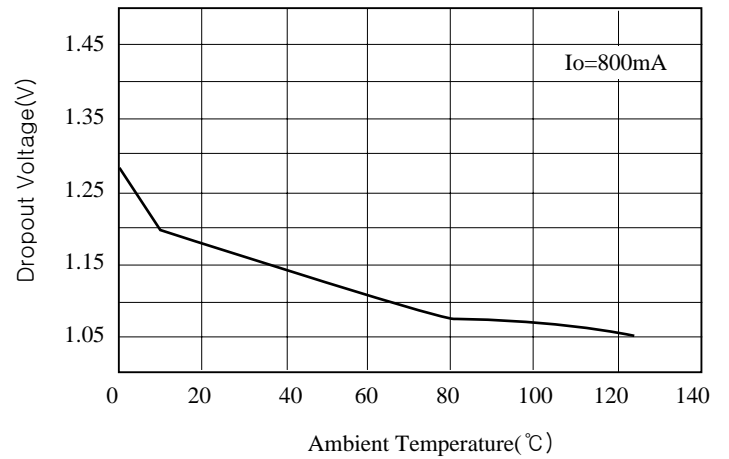



FR1117P/S/D/F-AD ~ FR1117P/S/D/F-5.0

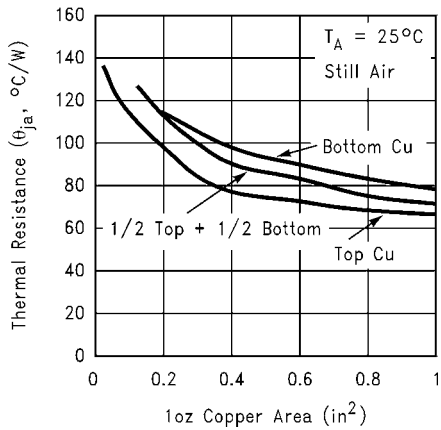

R θ JA vs 1-oz Copper Area for SOT-223

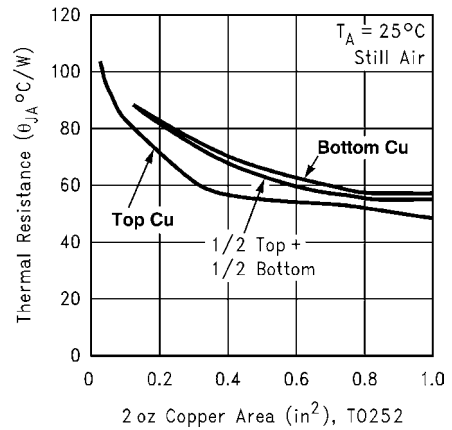

R θ JA vs 2-oz Copper Area for TO-252

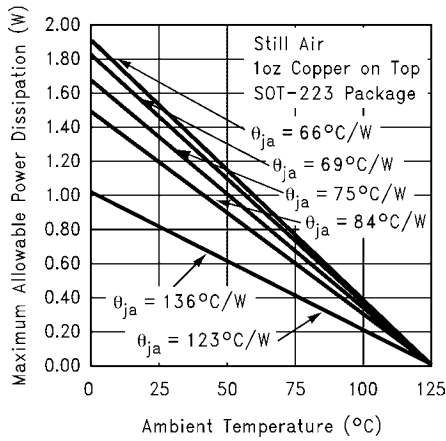

Maximum Allowable Power Dissipation vs Ambient Temperature for SOT-223

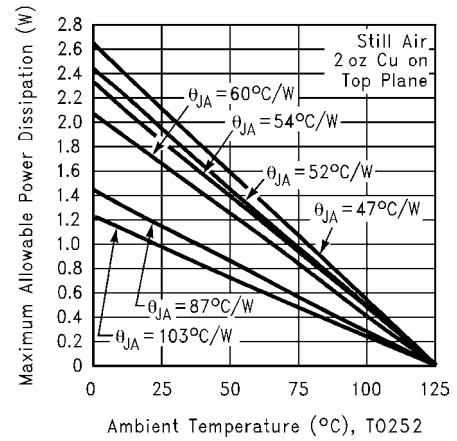

Maximum Allowable Power Dissipation vs Ambient Temperature for TO-252

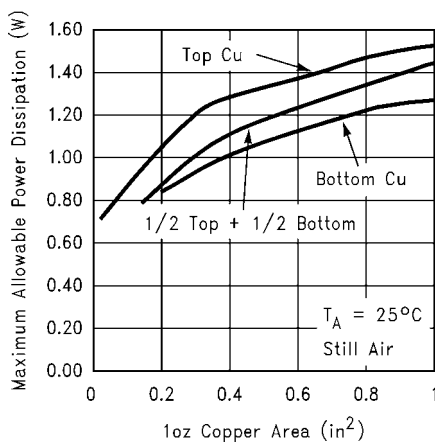

Maximum Allowable Power Dissipation vs 1-oz Copper Area for SOT-223

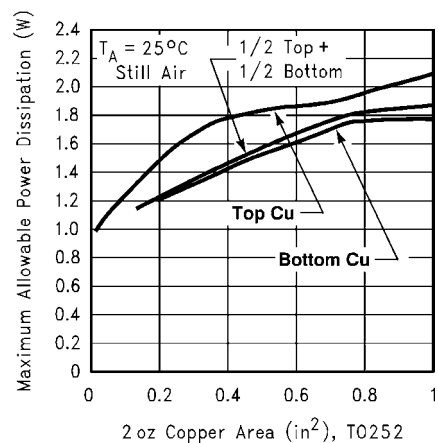

Maximum Allowable Power Dissipation vs 2-oz Copper Area for TO-252



APPLICATION INFORMATION

Maximum Output Current Capability

The FR1117 can deliver a continuous current of 1A over the full operating junction temperature range. However, the output current is limited by the restriction of power dissipation which differs from packages. A heat sink may be required depending on the maximum power dissipation and maximum ambient temperature of application. With respect to the applied package, the maximum output current of 1A may be still undeliverable due to the restriction of the power dissipation of FR1117. Under all possible conditions, the junction temperature must be within the range specified under operating conditions. The temperatures over the device are given by:

$$T_C = T_A + P_D \times \theta_{CA} / \quad T_J = T_C + P_D \times \theta_{JC} / \quad T_J = T_A + P_D \times \theta_{JA}$$

where T_J is the junction temperature, T_C is the case temperature, T_A is the ambient temperature, P_D is the total power dissipation of the device, θ_{CA} is the thermal resistance of case-to-ambient, θ_{JC} is the thermal resistance of junction-to-case, and θ_{JA} is the thermal resistance of junction to ambient. The total power dissipation of the device is given by:

$$P_D = P_{IN} - P_{OUT} = (V_N \times I_{IN}) - (V_{OUT} \times I_{OUT}) \\ = (V_{IN} \times (I_{OUT} + I_{GND})) - (V_{OUT} \times I_{OUT}) = (V_{IN} - V_{OUT}) \times I_{OUT} + V_{IN} \times I_{GND}$$

where I_{GND} is the operating ground current of the device which is specified at the Electrical Characteristics. The maximum allowable temperature rise (T_{Rmax}) depends on the maximum ambient temperature (T_{Amax}) of the application, and the maximum allowable junction temperature (T_{Jmax}):

$$T_{Rmax} = T_{Jmax} - T_{Amax}$$

The maximum allowable value for junction-to-ambient thermal resistance, θ_{JA} , can be calculated using the formula:

$$\theta_{JA} = T_{Rmax} / P_D = (T_{Jmax} - T_{Amax}) / P_D$$

FR1117 is available in SOT-223, TO-252 and SOT-89 packages. The thermal resistance depends on amount of copper area or heat sink, and on air flow. If the maximum allowable value of θ_{JA} calculated above is over 137°C/W for SOT-223 package, over 105 °C/W for TO-252 package, over 315 °C/W for SOT-89 package, no heat sink is needed since the package can dissipate enough heat to satisfy these requirements. If the value for allowable θ_{JA} falls near or below these limits, a heat sink or proper area of copper plane is required. In summary, the absolute maximum ratings of thermal resistances are as follow:

Absolute Maximum Ratings of Thermal Resistance

Characteristic	Symbol	Rating	Unit
Thermal Resistance Junction-To-Ambient / SOT-223	$\theta_{JA-SOT-223}$	137	°C/W
Thermal Resistance Junction-To-Ambient / TO-252	$\theta_{JA-TO-252}$	105	°C/W
Thermal Resistance Junction-To-Ambient / SOT-89	$\theta_{JA-SOT-89}$	315	°C/W

No heat sink / No air flow / No adjacent heat source / 0.066 inch² copper area. ($T_A=25^\circ\text{C}$)