

## FR151G thru FR157G

### 1.Feature & Dimensions

- \* Plastic package has Underwriters Laboratory Flammability Classification 94V-0
- \* High temperature metallurgically bonded construction
- \* Cavity-free glass passivated junction
- \* Capable of meeting environmental standards of MIL-S-19500
- \* 1.5 A operation at TA=55°C with no thermal runaway
- \* For use in high frequency rectifier circuits
- \* Fast switching for high efficiency
- \* Typical IR less than 1.0μA
- \* High temperature soldering guaranteed: 260°C/10 seconds
- \* 0.375" (9.5mm) lead length, 5 lbs. (2.3kg) tension

### 2.Mechanical Data

- Case:** JEDEC DO-15, molded plastic body
- Terminals:** Plated axial leads, solderable per MIL-STD-750, Method 2026
- Polarity:** Color band denotes cathode end
- Mounting Position:** Any
- Weight:** 0.015 oz., 0.40 g
- Handling precaution:** None

### 3.Electrical Characteristic

#### Maximum Ratings & Thermal Characteristics Ratings at 25°C ambient temperature unless otherwise specified.

| Parameter Symbol  | symbol          | FR 151G     | FR 152G | FR 153G | FR 154G | FR 155G | FR15 5PG | FR 156G | FR 157G | FR15 7PG | Unit |
|---|-----------------|-------------|---------|---------|---------|---------|----------|---------|---------|----------|------|
| Maximum repetitive peak reverse voltage   | $V_{RRM}$       | 50          | 100     | 200     | 400     | 600     | 600      | 800     | 1000    | 1000     | V    |
| Maximum RMS voltage   | $V_{RMS}$       | 35          | 70      | 140     | 280     | 420     | 420      | 560     | 700     | 700      | V    |
| Maximum DC blocking voltage   | $V_{DC}$        | 50          | 100     | 200     | 400     | 600     | 600      | 800     | 1000    | 1000     | V    |
| Maximum average forward rectified current 0.375" (9.5mm) lead length at $T_A = 55^\circ\text{C}$              | $I_{F(AV)}$     | 1.5         |         |         |         |         |          |         |         |          | A    |
| Peak forward surge current 8.3ms single half sine-wave superimposed on rated load (JEDEC Method)              | $I_{FSM}$       | 60          |         |         |         |         |          |         |         |          | A    |
| Maximum full load reverse current, full cycle average, 0.375"(9.5mm) lead lengths at $T_A = 55^\circ\text{C}$ | $I_{R(AV)}$     | 100         |         |         |         |         |          |         |         |          | μA   |
| Typical thermal resistance (Note 2)   | $R_{\theta JA}$ | 55          |         |         |         |         |          |         |         |          | °C/W |
| Operating junction and storage temperature range  | $T_J, T_{STG}$  | -50 to +150 |         |         |         |         |          |         |         |          | °C   |

#### Electrical Characteristics Ratings at 25°C ambient temperature unless otherwise specified.

| Parameter Symbol   | symbol   | FR 151G    | FR 152G | FR 153G | FR 154G | FR 155G | FR15 5PG | FR 156G | FR 157G | FR15 7PG | Unit |
|--|----------|------------|---------|---------|---------|---------|----------|---------|---------|----------|------|
| Maximum instantaneous forward voltage at 1.5A  | $V_F$    | 1.3        |         |         |         |         |          |         |         |          | V    |
| Maximum DC reverse current $T_A = 25^\circ\text{C}$ at rated DC blocking voltage $T_A = 125^\circ\text{C}$ | $I_R$    | 5.0<br>200 |         |         |         |         |          |         |         |          | μA   |
| Typical reverse recovery time (Note 1)   | $t_{rr}$ | 150        |         |         | 250     | 150     | 500      | 250     |         |          | ns   |
| Typical junction capacitance at 4.0V, 1MHz   | $C_J$    | 35         |         |         |         |         |          |         |         |          | PF   |

NOTES:

1.  $I_F = 0.5A, I_R = 1.0A, I_{RR} = 0.25A$
2. Thermal resistance from junction to ambient at 0.375" (9.5mm) lead length, P.C.B. mounted

### Glass Passivated Junction Fast Switching Rectifiers

Reverse Voltage 50 to 1000V  
Forward Current 1.5A

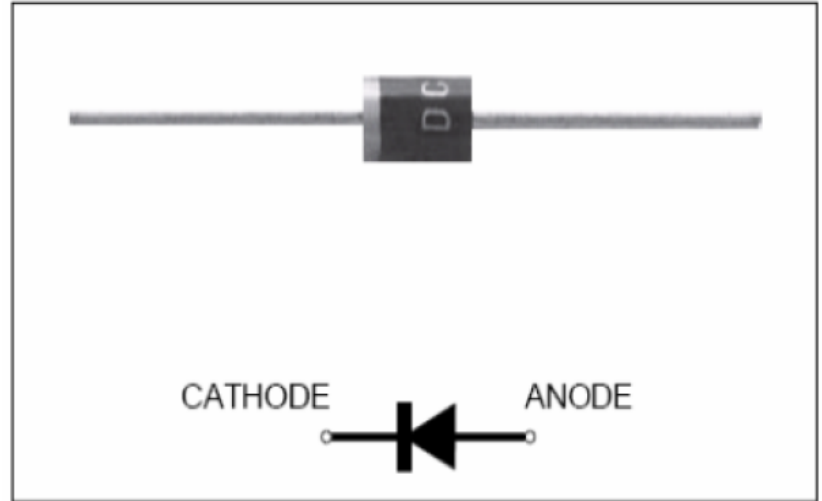

We declare that the material of product compliance with RoHS requirements.

#### 4. Characteristic Curves ( TA = 25°C unless otherwise noted )

Fig. 1 - Forward Current Derating Curve

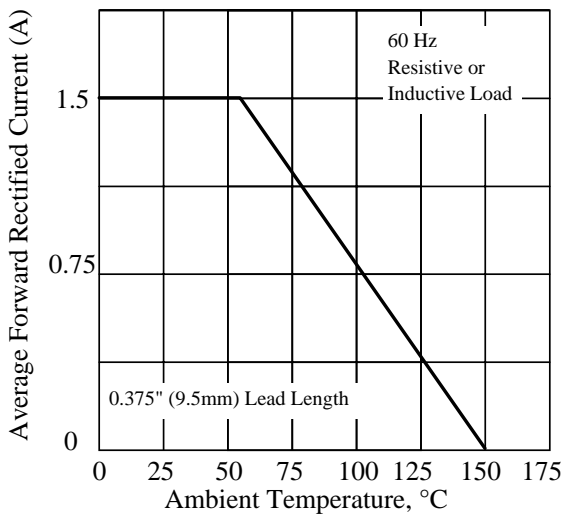

Fig. 2 - Maximum Non-repetitive Peak Forward Surge Current

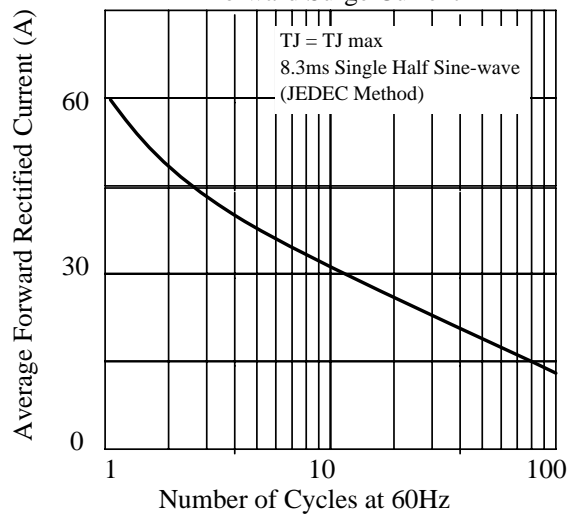

Fig 3. - Typical Instantaneous Forward Characteristics

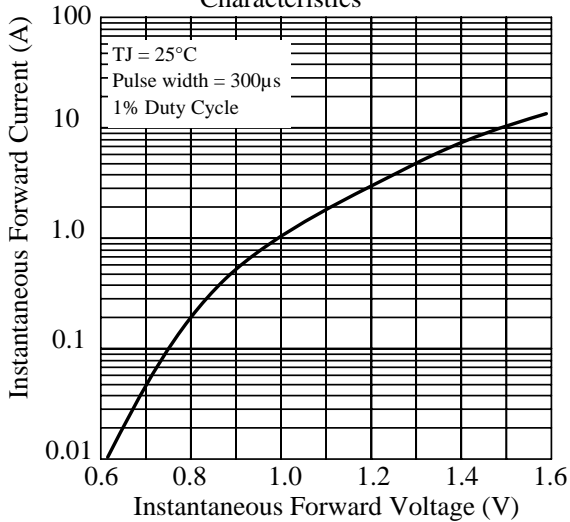

Fig 4. - Typical Reverse Characteristics

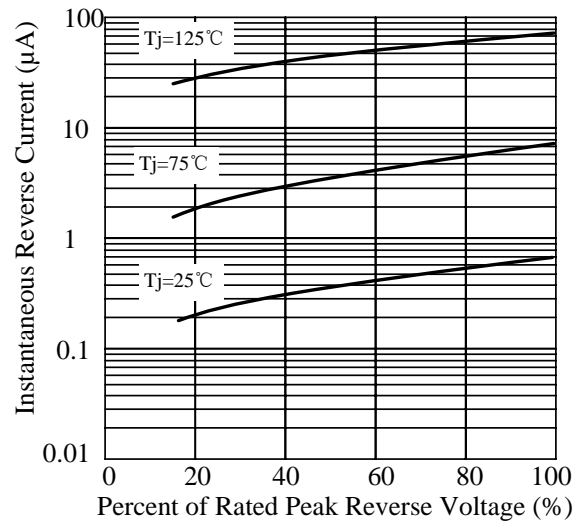

Fig 5. - typical transient thermal impedance

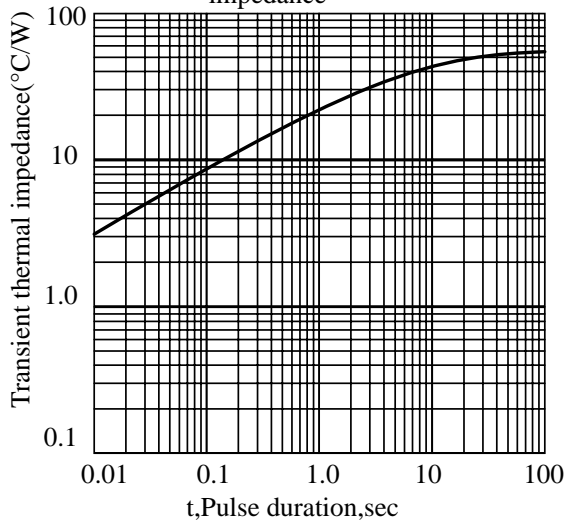
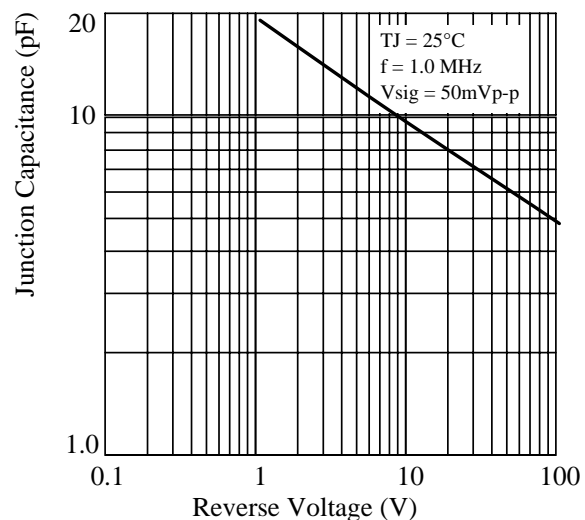
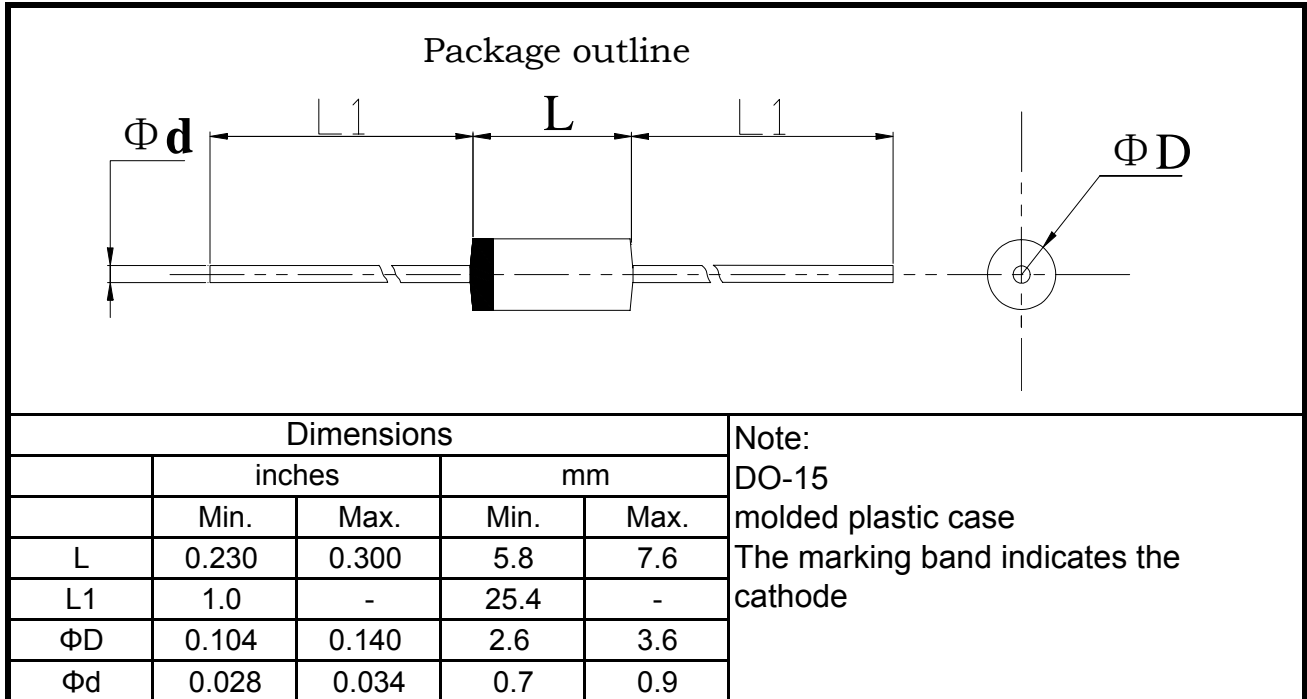

Fig 6. - Typical Junction Capacitance



**5.Package Dimensions in inches and (millimeters)**

## Packing Of Plastic-Sealed Axial Lead Diodes

### 1. 卷盘/Reel Packing (52mm)

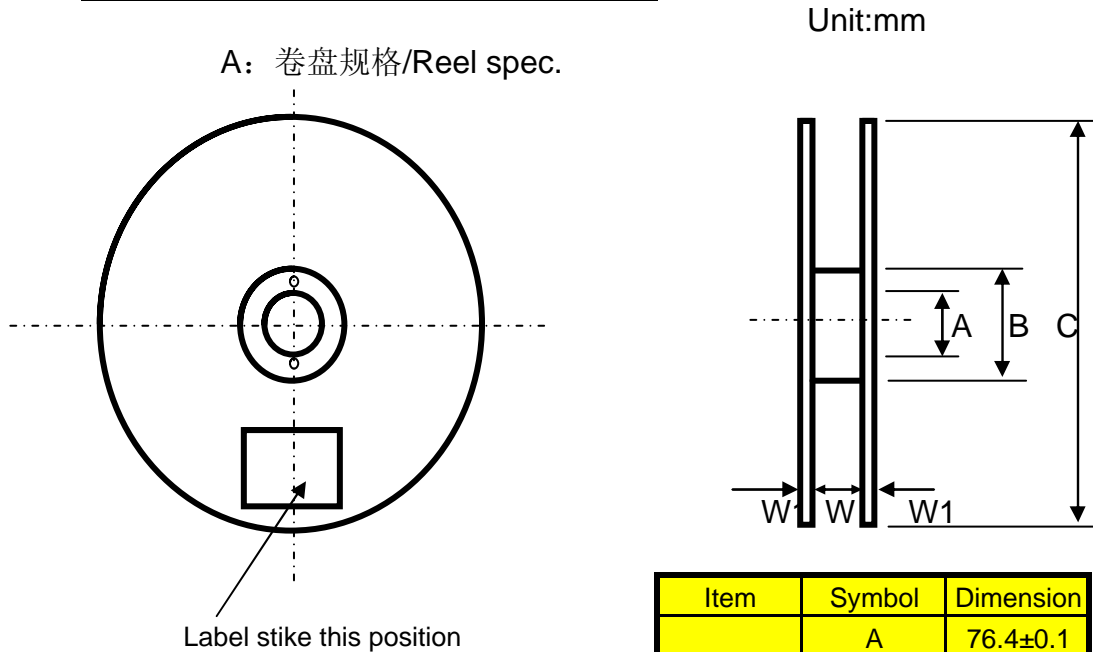

| Item      | Symbol | Dimension |
|-----------|--------|-----------|
| Dimeter   | A      | 76.4±0.1  |
|           | B      | 82.5±0.2  |
|           | C      | 330±0.5   |
| Width     | W      | 72±0.2    |
| Thickness | W1     | 3±0.2     |

### B: 外箱规格/Outer Box Specification

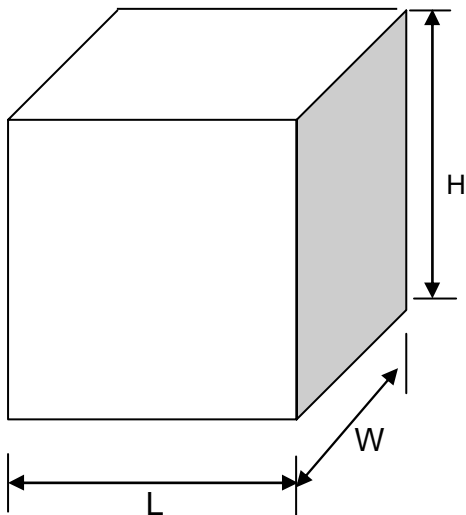

| Item | Symbol | Dimension |
|------|--------|-----------|
| Size | L      | 350±2     |
|      | W      | 350±2     |
|      | H      | 340±4     |

按以上包装方式: (As per the above spec)

|                   | 外型/Outside    |       |          |
|-------------------|---------------|-------|----------|
|                   | DO-41 & A-405 | DO-15 | DO-201AD |
| Q'ty/Taping       | 5K            | 4K    | 1.4K     |
| Q'ty/Packing Case | 20K           | 16K   | 5.6K     |

**2. 弹带盒装/Ammo Packing**

Unit:mm

A: 弹带盒规格/Ammo Box Spec.



| Item       | Symbol | Dimension | Notes     |
|------------|--------|-----------|-----------|
| Box's Size | L      | 260±2     | 52mm TYPE |
|            | W      | 76±2      |           |
|            | H      | 100±4     |           |
|            | L      | 250±3     | 26mm TYPE |
|            | W      | 45±3      |           |
|            | H      | 95±5      |           |

B: 外箱规格/Outer Box Specification

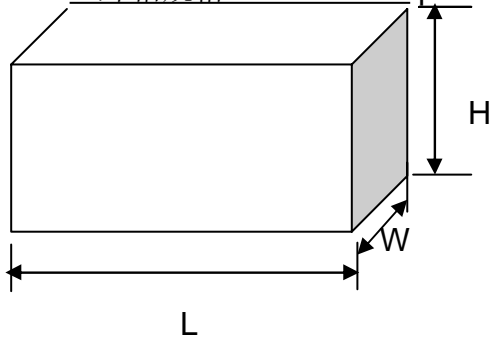

| Item        | Symbol | Dimension | Notes     |
|-------------|--------|-----------|-----------|
| Case's Size | L      | 430±2     | 52mm TYPE |
|             | W      | 280±2     |           |
|             | H      | 225±4     |           |
|             | L      | 435±3     | 26mm TYPE |
|             | W      | 280±3     |           |
|             | H      | 295±5     |           |

按以上包装方式: (As per the above spec)

|                                | 外型/Outside          |       |          |
|--------------------------------|---------------------|-------|----------|
|                                | A-405 & DO-41 & R-1 | DO-15 | DO-201AD |
| Q'ty/Taping                    | 3K                  | 2K    | 0.8K     |
| Q'ty/Packing Case<br>26mm/TYPE | 30K                 | 20K   | 7.2K     |
| Q'ty/Packing Case<br>52mm/TYPE | 60K                 | 40K   | 14.4K    |

**3. 散装/Bulk Packing**

**A. 包装盒尺寸/Box Dimension**

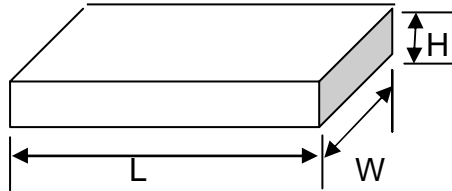

( DO-41&DO-15 )

| Item       | Symbol | Dimension |
|------------|--------|-----------|
| Box's Size | L      | 200±2     |
|            | W      | 84±2      |
|            | H      | 21±2      |

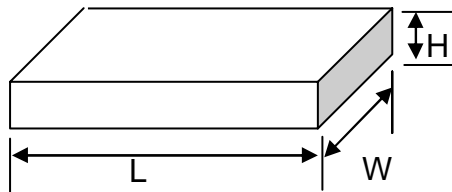

( DO-201AD )

| Item       | Symbol | Dimension |
|------------|--------|-----------|
| Box's Size | L      | 200±2     |
|            | W      | 84±2      |
|            | H      | 29±2      |

**B: 外箱规格/Outer Box Specification**

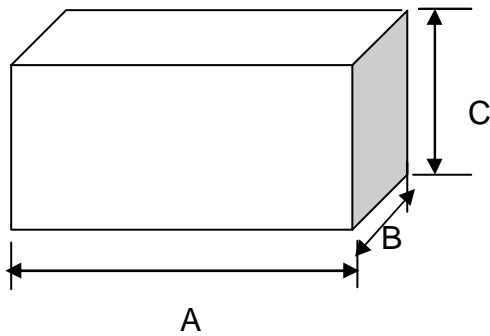

| Item        | Symbol | Dimension |
|-------------|--------|-----------|
| Case's Size | L      | 465±2     |
|             | W      | 225±2     |
|             | H      | 260±4     |

按以上包装方式: (As per the above spec)

|                   | 外型/Outside      |       |          |
|-------------------|-----------------|-------|----------|
|                   | DO-41&A-405&R-1 | DO-15 | DO-201AD |
| Q'ty/Taping       | 1K              | 0.5K  | 0.3K     |
| Q'ty/Packing Case | 50K             | 25K   | 12K      |

4. 编带图形及规格/Taping Specification

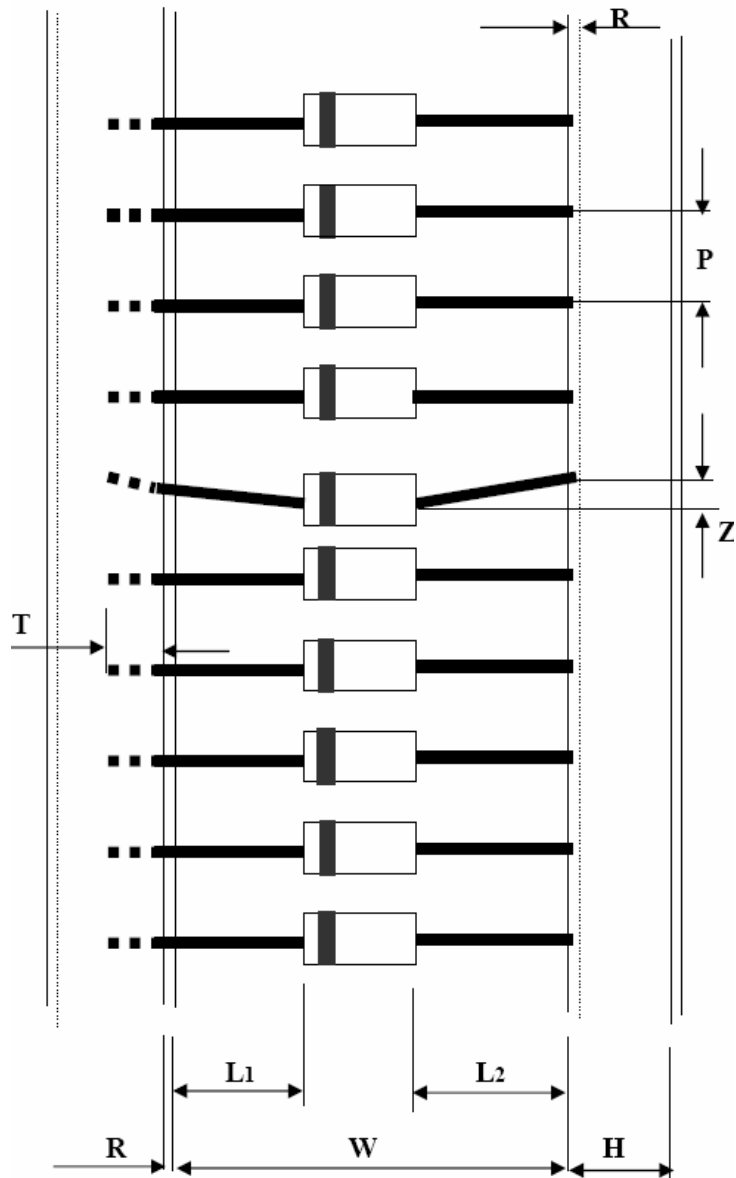

Unit:mm

| 尺寸代号           | 编带尺寸/Tape Dimension |              |              |
|----------------|---------------------|--------------|--------------|
| Dimension Code | 26/tape             | 52/tape      | 52/tape#     |
| W              | 26 0.0/+1.6         | 52 -1.0/+2.0 | 52 -1.0/+2.0 |
| P              | 5±0.5               | 5±0.5        | 10±0.5       |
| L1-L2          | <1.0                | <1.2         | <1.2         |
| H              | 6±1.0               | 6±1.0        | 6±1.0        |
| Z              | <1.2                | <1.2         | <1.2         |
| R              | <1.0                | <1.0         | <1.0         |
| T              | >3.2                | >3.2         | >3.2         |

注: 52编带# 为DO-201AD编带规格

Remark: 52 tape# is DO-201AD taping spec.