



DC COMPONENTS CO., LTD.

RECTIFIER SPECIALISTS

FR1A
THRU
FR1K

TECHNICAL SPECIFICATIONS OF SURFACE MOUNT FAST RECOVERY RECTIFIER

VOLTAGE RANGE - 50 to 800 Volts

CURRENT - 1.0 Ampere

FEATURES

- * Ideal for surface mounted applications
- * Low leakage current
- * Glass passivated junction

MECHANICAL DATA

- * Case: Molded plastic
- * Epoxy: UL 94V-0 rate flame retardant
- * Terminals: Solder plated, solderable per MIL-STD-750, Method 2026
- * Polarity: As marked
- * Mounting position: Any
- * Weight: 0.093 gram



SMB (DO-214AA)

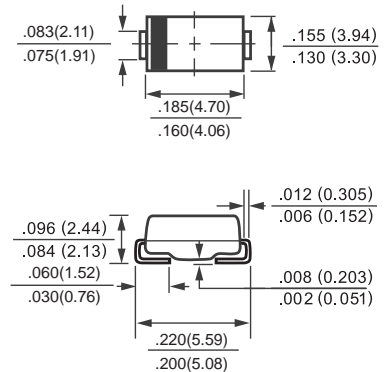

Dimensions in inches and (millimeters)

MAXIMUM RATINGS AND ELECTRICAL CHARACTERISTICS

Ratings at 25 °C ambient temperature unless otherwise specified.
 Single phase, half wave, 60 Hz, resistive or inductive load.
 For capacitive load, derate current by 20%.

	SYMBOL	FR1A	FR1B	FR1D	FR1G	FR1J	FR1K	UNITS
Maximum Recurrent Peak Reverse Voltage	VRRM	50	100	200	400	600	800	Volts
Maximum RMS Voltage	VRMS	35	70	140	280	420	560	Volts
Maximum DC Blocking Voltage	Vbc	50	100	200	400	600	600	Volts
Maximum Average Forward Rectified Current at TA = 75 °C	IO	1.0						Amps
Peak Forward Surge Current 8.3 ms single half sine-wave superimposed on rated load (JEDEC Method)	IFSM	30						Amps
Maximum Instantaneous Forward Voltage at 1.0A DC	VF	1.3						Volts
Maximum DC Reverse Current at Rated DC Blocking Voltage	@ TA = 25 °C	5.0						uAmps
	@ TA = 100 °C	150						
Maximum Reverse Recovery Time (Note 3)	trr	150	250	500				nSec
Typical Thermal Resistance (Note 2)	RθJL	12						°C/W
Typical Junction Capacitance (Note 1)	Cj	30						pF
Operating and Storage Temperature Range	TJ,TSTG	-65 to + 175						°C

- NOTES : 1. Measured at 1 MHz and applied reverse voltage of 4.0 volts.
 2. Thermal Resistance (Junction to Ambient), 0.2x0.2in² (5X5mm²) copper pads to each terminal.
 3. Test Conditions: IF=0.5A, IR=1.0A, IRR=0.25A.

RATING AND CHARACTERISTIC CURVES (FR1A THRU FR1K)

FIG. 1 - TYPICAL FORWARD CURRENT DERATING CURVE

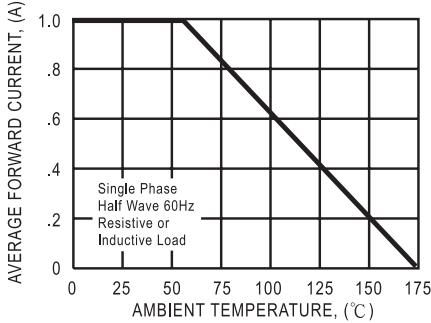

FIG. 2 - MAXIMUM NON-REPETITIVE FORWARD SURGE CURRENT

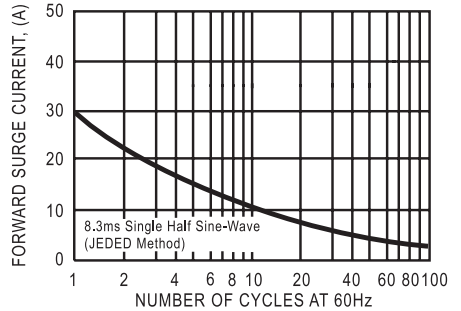

FIG. 3 - TYPICAL REVERSE CHARACTERISTICS

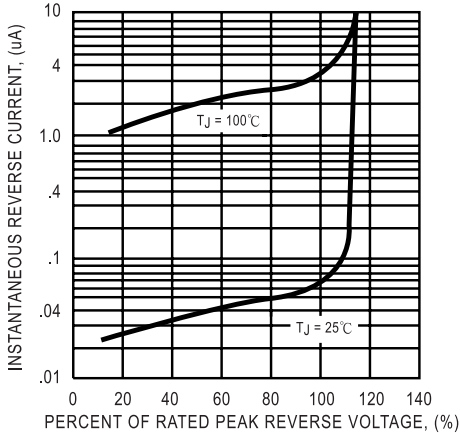

FIG. 4 - TYPICAL INSTANTANEOUS FORWARD CHARACTERISTICS

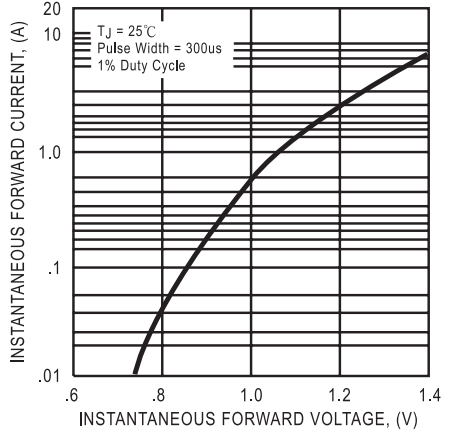
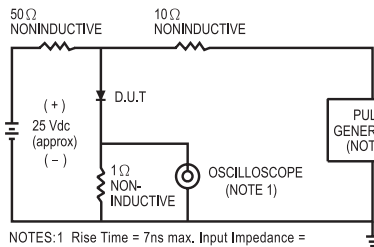

FIG. 5 - TEST CIRCUIT DIAGRAM AND REVERSE RECOVERY TIME CHARACTERISTIC



NOTES: 1 Rise Time = 7ns max. Input Impedance = 1 megohm, 22 pF.
 2. Rise Time = 10ns max. Source Impedance = 50 ohms.

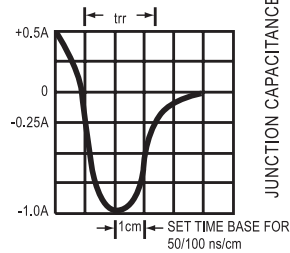
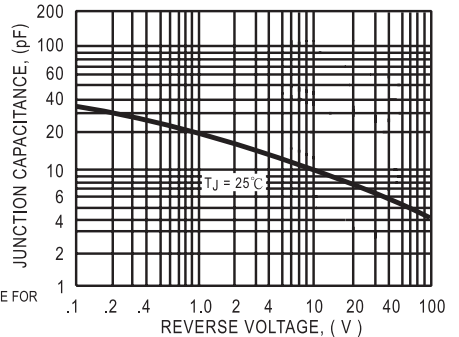

FIG. 6 - TYPICAL JUNCTION CAPACITANCE



DC COMPONENTS CO., LTD.