



Micro Commercial Components



Micro Commercial Components
20736 Marilla Street Chatsworth
CA 91311
Phone: (818) 701-4933
Fax: (818) 701-4939

FR501
THRU
FR507

Features

- Epoxy meets UL 94 V-0 flammability rating
Moisture Sensitivity Level 1
Low Forward Voltage Drop and High Current Capability
Fast Switching Speed For High Efficiency
Lead Free Finish/RoHS Compliant(Note 1) ("P" Suffix designates RoHS Compliant. See ordering information)

Maximum Ratings

- Operating Temperature: -55°C to +150°C
Storage Temperature: -55°C to +150°C

Table with 5 columns: MCC Catalog Number, Device Marking, Maximum Recurrent Peak Reverse Voltage, Maximum RMS Voltage, Maximum DC Blocking Voltage. Rows include FR501 through FR507.

Electrical Characteristics @ 25°C Unless Otherwise Specified

Table with 4 columns: Parameter, Symbol, Value, Conditions. Rows include Average Forward Current, Peak Forward Surge Current, Maximum Instantaneous Forward Voltage, Maximum DC Reverse Current At Rated DC Blocking Voltage, Maximum Reverse Recovery Time, Typical Junction Capacitance.

Notes:1.High Temperature Solder Exemption Applied, see EU Directive Annex 7.

5 Amp Fast Recovery Rectifier
50 to 1000 Volts

DO-201AD

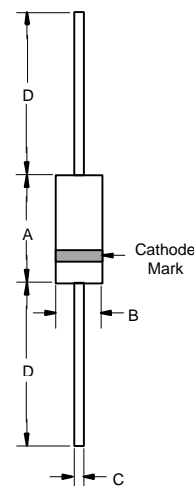
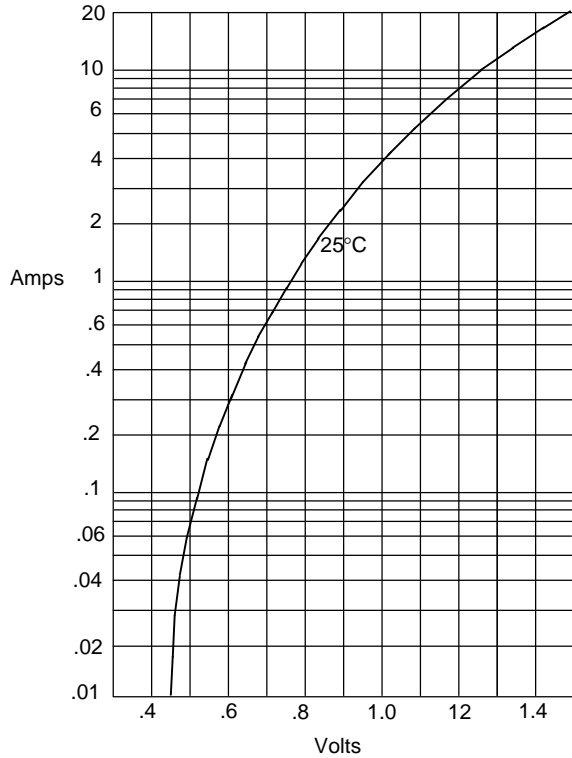

Table with 6 columns: DIM, INCHES (MIN, MAX), MM (MIN, MAX), NOTE. Rows include dimensions A, B, C, D.

FR501 thru FR507

Figure 1
Typical Forward Characteristics



Instantaneous Forward Current - Amperes *versus*
Instantaneous Forward Voltage - Volts

Figure 2
Forward Derating Curve

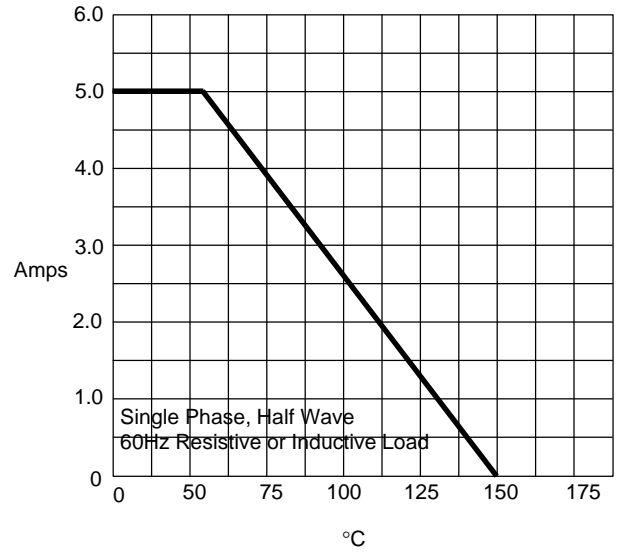

Average Forward Rectified Current - Amperes *versus*
Ambient Temperature - °C

Figure 3
Junction Capacitance

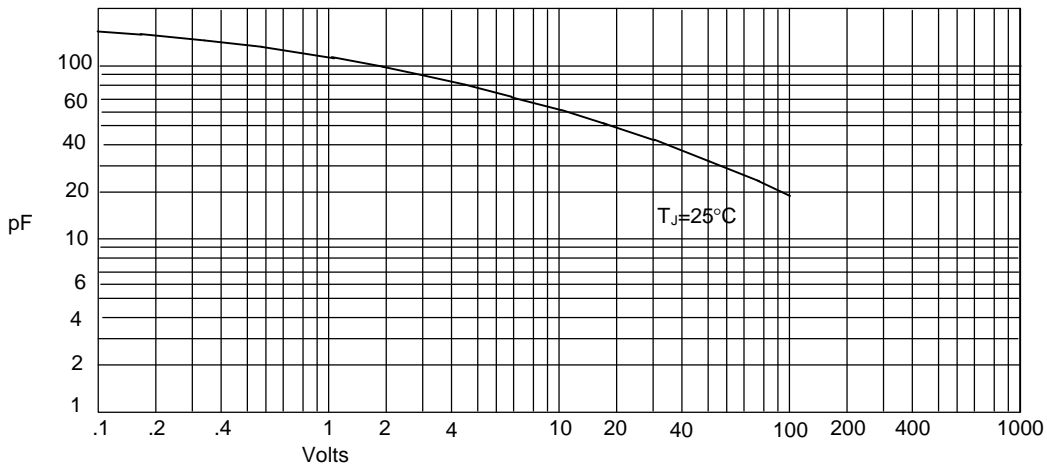

Junction Capacitance - pF *versus*
Reverse Voltage - Volts

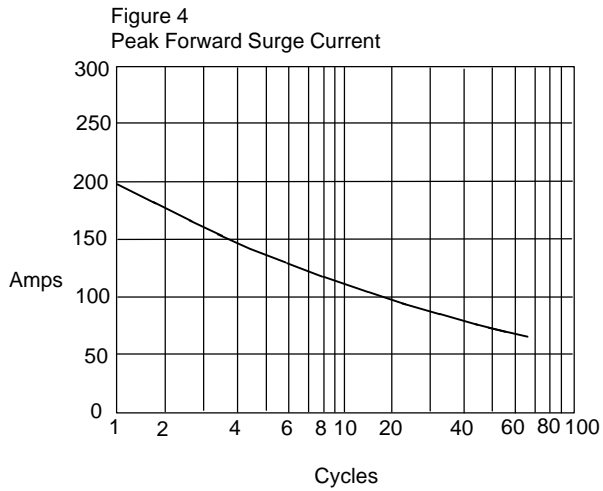

Peak Forward Surge Current - Amperes versus
Number Of Cycles At 60Hz - Cycles

Figure 5
Reverse Recovery Time Characteristic And Test Circuit Diagram

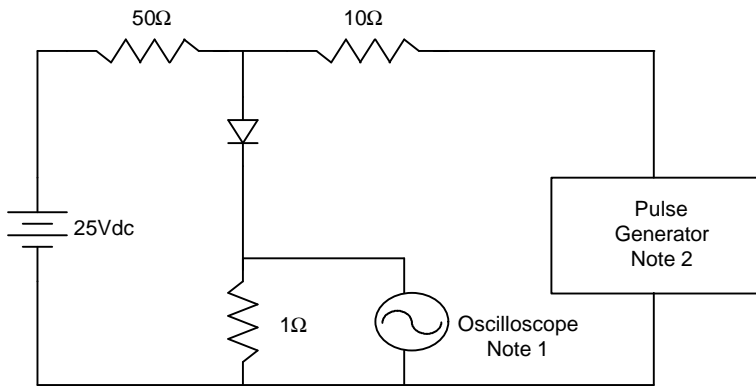

- Notes:
1. Rise Time = 7ns max.
Input impedance = 1 megohm, 22pF
 2. Rise Time = 10ns max.
Source impedance = 50 ohms
 3. Resistors are non-inductive

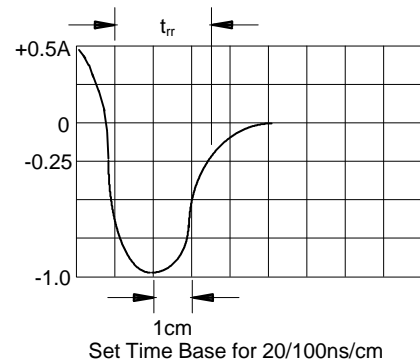



Micro Commercial Components

Ordering Information :

Device	Packing
Part Number-TP	Tape&Reel: 1.2Kpcs/Reel
Part Number-AP	Ammo Packing: 1.2Kpcs/Ammo Box
Part Number-BP	Bulk: 12Kpcs/Carton

*****IMPORTANT NOTICE*****

Micro Commercial Components Corp. reserves the right to make changes without further notice to any product herein to make corrections, modifications , enhancements , improvements , or other changes . **Micro Commercial Components Corp .** does not assume any liability arising out of the application or use of any product described herein; neither does it convey any license under its patent rights ,nor the rights of others . The user of products in such applications shall assume all risks of such use and will agree to hold **Micro Commercial Components Corp .** and all the companies whose products are represented on our website, harmless against all damages.

*****LIFE SUPPORT*****

MCC's products are not authorized for use as critical components in life support devices or systems without the express written approval of Micro Commercial Components Corporation.

*****CUSTOMER AWARENESS*****

Counterfeiting of semiconductor parts is a growing problem in the industry. Micro Commercial Components (MCC) is taking strong measures to protect ourselves and our customers from the proliferation of counterfeit parts. MCC strongly encourages customers to purchase MCC parts either directly from MCC or from Authorized MCC Distributors who are listed by country on our web page cited below. Products customers buy either from MCC directly or from Authorized MCC Distributors are genuine parts, have full traceability, meet MCC's quality standards for handling and storage. **MCC will not provide any warranty coverage or other assistance for parts bought from Unauthorized Sources.** MCC is committed to combat this global problem and encourage our customers to do their part in stopping this practice by buying direct or from authorized distributors.