

## 18V, 3A, 500KHz Synchronous Step-Down DC/DC Converter

### Description

The FR8205 is a synchronous step-down DC/DC converter that provides 4.5V to 18V input voltage range and 3A continuous load current capability. At light load condition, the FR8205 can operate at power saving mode to support high efficiency and reduce power loss.

The FR8205 fault protection includes cycle-by-cycle current limit, UVLO, hiccup short circuit protection and thermal shutdown. The internal 2ms soft-start function prevents inrush current at turn-on. This device uses current mode control scheme which provides fast transient response. Internal compensation function reduces external compensatory components and simplifies the design process. In shutdown mode, the supply current is about 1 $\mu$ A.

The FR8205 is offered in FC-SOT-23-6 package, which provides good thermal conductance.

### Features

- Low  $R_{DS(ON)}$  Integrated Power MOSFET (90m $\Omega$ /50m $\Omega$ )
- Internal Compensation Function
- Wide Input Voltage Range: 4.5V to 18V
- Adjustable Output Voltage Down to 0.6V
- 3A Output Current
- 500kHz Switching Frequency
- Internal 2ms Soft-Start
- Cycle-by-Cycle Current Limit
- Over Temperature Protection with Auto Recovery
- Under Voltage Lockout
- Hiccup Short Circuit Protection
- FC-SOT-23-6 Package

### Applications

- STB (Set-Top-Box)
- LCD Display, TV
- Distributed Power System
- Networking, XDSL Modem

### Pin Assignments

S6 Package (FC-SOT-23-6)

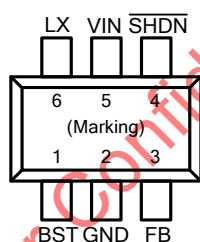
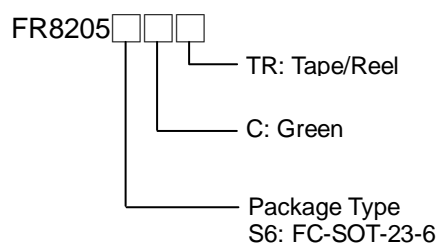

Figure 1. Pin Assignments of FR8205

### Ordering Information



### FC-SOT-23-6 Marking

Part Number	Product Code
FR8205S6CTR	FF7

## Typical Application Circuit

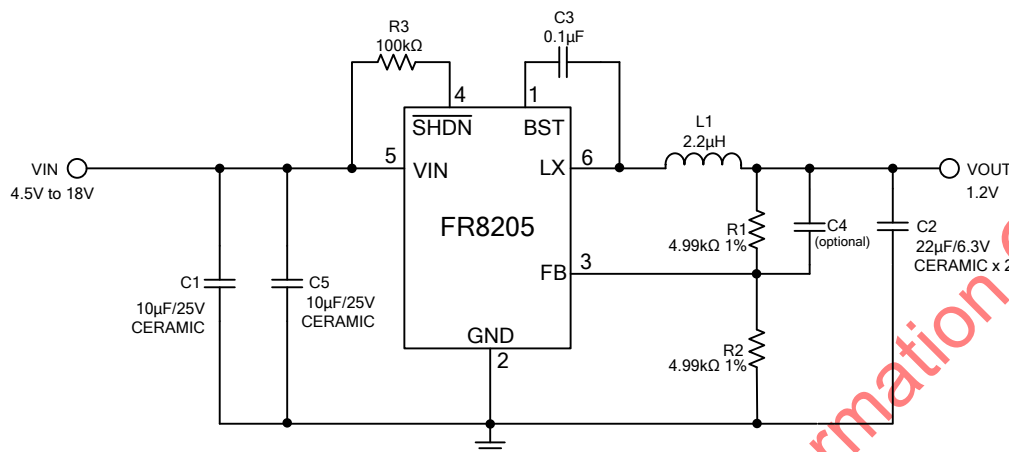

Figure 2. C<sub>IN</sub>/C<sub>OUT</sub> use Ceramic Capacitors Application Circuit

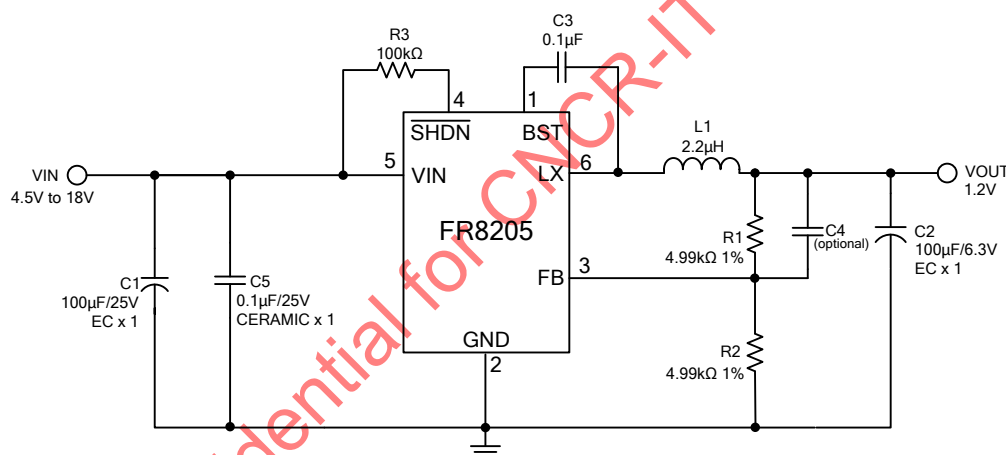

Figure 3. C<sub>IN</sub>/C<sub>OUT</sub> use Electrolytic Capacitors Application Circuit

V<sub>IN</sub>=12V, the recommended BOM list is as below.

V <sub>OUT</sub>	C1	R1	R2	C5	C4	L1	C2
1.2V	10μF MLCC	4.99kΩ	4.99kΩ	10μF MLCC	10pF~10nF	2.2μH	22μF MLCC x2
1.8V	10μF MLCC	30.9kΩ	15.4kΩ	10μF MLCC	10pF~10nF	3.3μH	22μF MLCC x2
2.5V	10μF MLCC	30.9kΩ	9.76kΩ	10μF MLCC	10pF~10nF	4.7μH	22μF MLCC x2
3.3V	10μF MLCC	30kΩ	6.65kΩ	10μF MLCC	10pF~10nF	4.7μH	22μF MLCC x2
5V	10μF MLCC	30.9kΩ	4.22kΩ	10μF MLCC	10pF~10nF	6.8μH	22μF MLCC x2
1.2V	100μF EC	4.99kΩ	4.99kΩ	0.1μF	--	2.2μH	100μF EC
1.8V	100μF EC	30.9kΩ	15.4kΩ	0.1μF	--	3.3μH	100μF EC
2.5V	100μF EC	30.9kΩ	9.76kΩ	0.1μF	--	4.7μH	100μF EC
3.3V	100μF EC	30kΩ	6.65kΩ	0.1μF	--	4.7μH	100μF EC
5V	100μF EC	30.9kΩ	4.22kΩ	0.1μF	--	6.8μH	100μF EC

Table 1. Recommended Component Values

## Functional Pin Description

Pin Name	Pin No.	Pin Function
BST	1	High side gate drive boost pin. A capacitor rating between 10nF~100nF must be connected from this pin to LX. It can boost the gate drive to fully turn on the internal high side NMOS.
GND	2	Ground pin.
FB	3	Voltage feedback input pin. Connect FB and VOUT with a resistive voltage divider. This IC senses feedback voltage via FB and regulates it at 0.6V.
$\overline{\text{SHDN}}$	4	Enable input pin. Pull high to turn on IC, and pull low to turn off IC. Connect VIN with a 100k $\Omega$ resistor for self-startup.
VIN	5	Power supply input pin. Placed input capacitors as close as possible from VIN to GND to avoid noise influence.
LX	6	Power switching node. Connect an external inductor to this switching node.

## Block Diagram

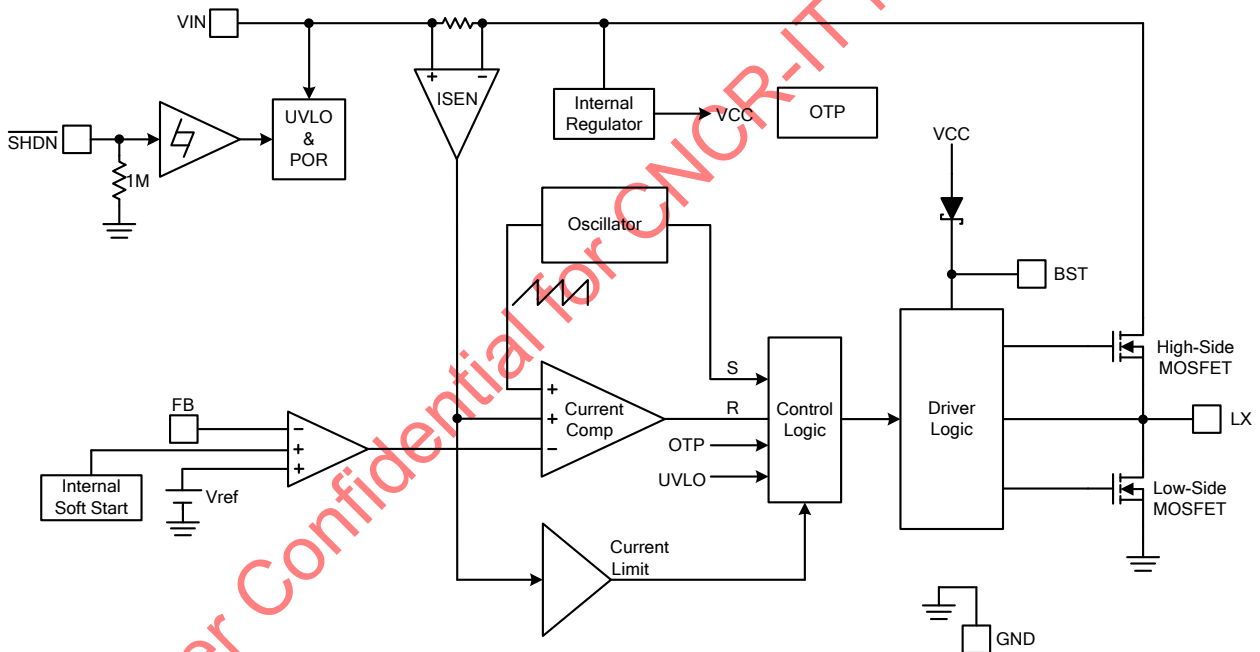

Figure 4. Block Diagram of FR8205

## Absolute Maximum Ratings <sup>(Note 1)</sup>

• Supply Voltage $V_{IN}$ -----	-0.3V to +20V
• Enable Voltage $V_{\overline{SHDN}}$ -----	-0.3V to +20V
• LX Voltage $V_{LX}$ -----	-0.3 to $V_{IN}+0.3V$
• Dynamic LX Voltage in 15ns Duration-----	-5V to $V_{IN}+5V$
• BST Pin Voltage $V_{BST}$ -----	-0.3V to $V_{LX}+6.5V$
• All Other Pins Voltage -----	-0.3V to +6V
• Maximum Junction Temperature ( $T_J$ ) -----	+150°C
• Storage Temperature ( $T_S$ ) -----	-65°C to +150°C
• Lead Temperature (Soldering, 10sec.) -----	+260°C
• Package Thermal Resistance, ( $\theta_{JA}$ ) <sup>(Note 2)</sup>	
FC-SOT-23-6 -----	+85°C/W
• Package Thermal Resistance, ( $\theta_{JC}$ )	
FC-SOT-23-6 -----	+20°C/W

Note 1: Stresses beyond this listed under "Absolute Maximum Ratings" may cause permanent damage to the device.

Note 2:  $\theta_{JA}$  is measured at  $T_A=25^\circ C$  on a high effective thermal conductivity 4-layer test PCB per JEDEC-51-7. The thermal resistance greatly varies with layout, copper thickness, number of layers and PCB size.

## Recommended Operating Conditions

• Supply Voltage $V_{IN}$ -----	+4.5V to +18V
• Operation Temperature Range -----	-40°C to +85°C

## Electrical Characteristics

( $V_{IN}=12V$ ,  $T_A=25^{\circ}C$ , unless otherwise specified.)

Parameter	Symbol	Conditions	Min	Typ	Max	Unit
$V_{IN}$ Quiescent Current	$I_{DDQ}$	$V_{\overline{SHDN}}=2V$ , $V_{FB}=1.0V$		1		mA
$V_{IN}$ Shutdown Supply Current	$I_{SD}$	$V_{\overline{SHDN}}=0V$		1	3	$\mu A$
Feedback Voltage	$V_{FB}$	$4.5V \leq V_{IN} \leq 18V$	0.588	0.6	0.612	V
High-Side MOSFET $R_{DS(ON)}$ (Note 3)	$R_{DS(ON)}$			90		m $\Omega$
Low-Side MOSFET $R_{DS(ON)}$ (Note 3)	$R_{DS(ON)}$			50		m $\Omega$
High-Side MOSFET Leakage Current	$I_{LX(leak)}$	$V_{\overline{SHDN}}=0V$ , $V_{LX}=0V$			10	$\mu A$
High-Side MOSFET Current Limit (Note 3)	$I_{LIMIT(HS)}$	Minimum Duty	3.5	4.5	6	A
Oscillation Frequency	$F_{OSC}$		400	500	600	kHz
Short Circuit Oscillation Frequency	$F_{OSC(short)}$	$V_{FB}=0V$		150		kHz
Maximum Duty Cycle	$D_{MAX}$	$V_{FB}=0.5V$		88		%
Minimum On Time (Note 3)	$T_{MIN}$			100		ns
Input Supply Voltage UVLO Threshold	$V_{UVLO(Vth)}$	$V_{IN}$ Rising		4.3		V
Input Supply Voltage UVLO Threshold Hysteresis	$V_{UVLO(HYS)}$			400		mV
Internal Soft-Start Period	$T_{SS}$			2		ms
$\overline{SHDN}$ Input Low Voltage	$V_{\overline{SHDN}(L)}$				0.4	V
$\overline{SHDN}$ Input High Voltage	$V_{\overline{SHDN}(H)}$		2			V
$\overline{SHDN}$ Input Current	$I_{\overline{SHDN}}$	$V_{\overline{SHDN}}=2V$		2		$\mu A$
Thermal Shutdown Threshold (Note 3)	$T_{SD}$			165		$^{\circ}C$

Note 3 : Not production tested.

Typical Performance Curves

$V_{IN}=12V$ ,  $V_{OUT}=3.3V$ ,  $C1=10\mu F \times 2$ ,  $C2=22\mu F \times 2$ ,  $L1=4.7\mu H$ ,  $T_A=+25^\circ C$ , unless otherwise noted.

$I_{OUT}=0A$

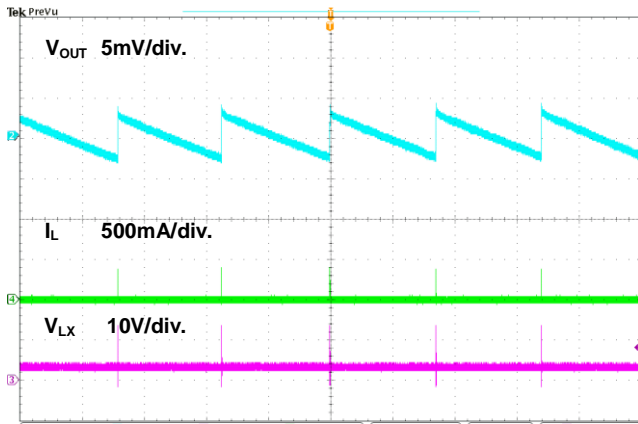

800us/div.  
Figure 5. Steady State Waveform

$I_{OUT}=3A$

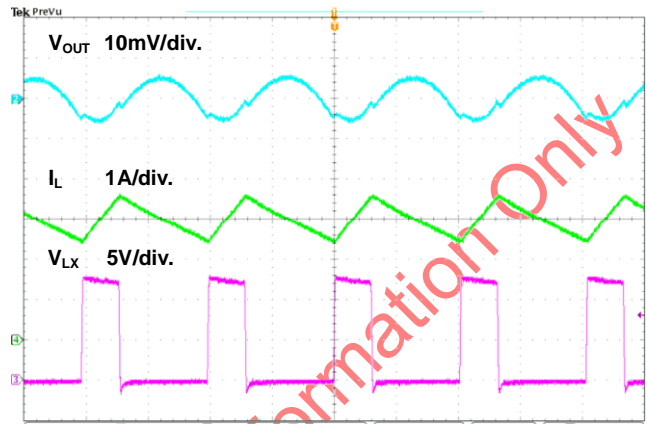

1us/div.  
Figure 6. Steady State Waveform

$I_{OUT}=0A$

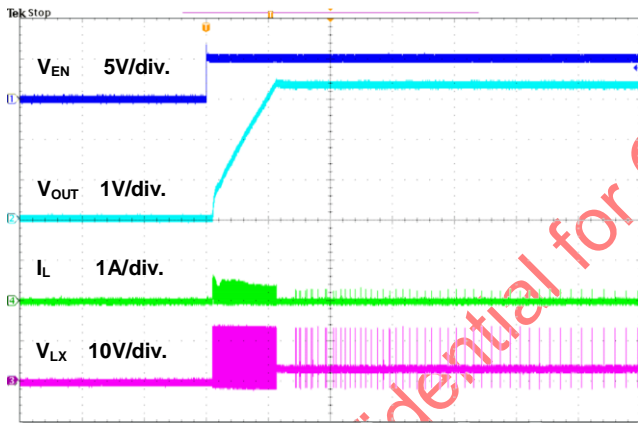

2ms/div.  
Figure 7. Power On through  $\overline{SHDN}$  Waveform

$I_{OUT}=3A$

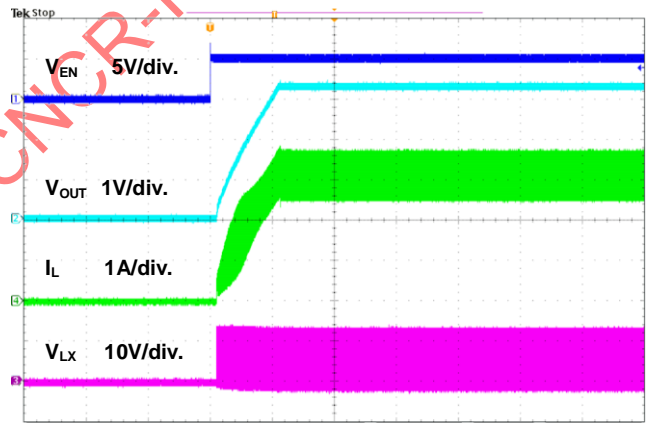

2ms/div.  
Figure 8. Power On through  $\overline{SHDN}$  Waveform

$I_{OUT}=0A$

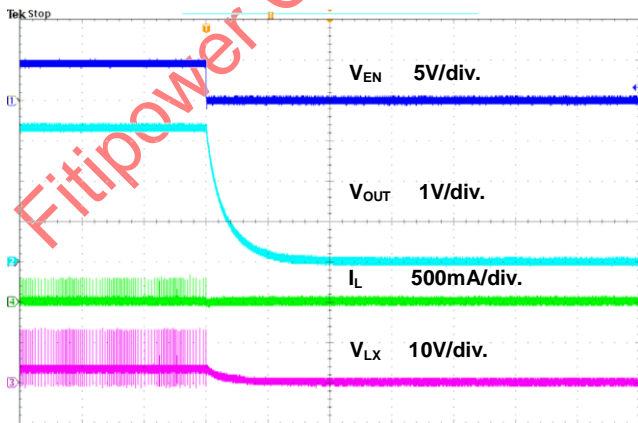

20ms/div.  
Figure 9. Power Off through  $\overline{SHDN}$  Waveform

$I_{OUT}=3A$

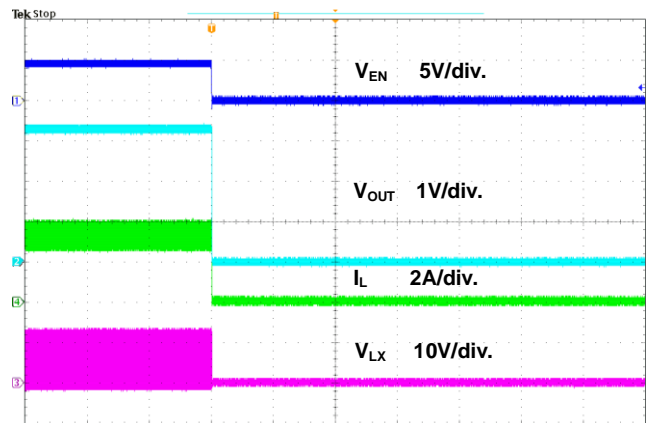

20ms/div.  
Figure 10. Power Off through  $\overline{SHDN}$  Waveform

Typical Performance Curves (Continued)

$V_{IN}=12V$ ,  $V_{OUT}=3.3V$ ,  $C1=10\mu F \times 2$ ,  $C2=22\mu F \times 2$ ,  $L1=4.7\mu H$ ,  $T_A=+25^\circ C$ , unless otherwise noted.

$I_{OUT}=0A$

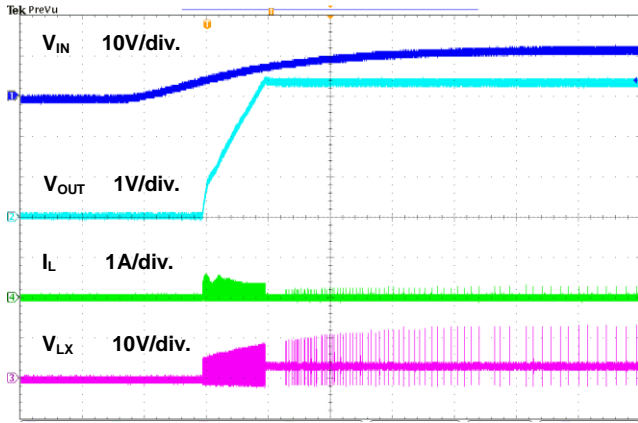

Figure 11. Power On through VIN Waveform

$I_{OUT}=3A$

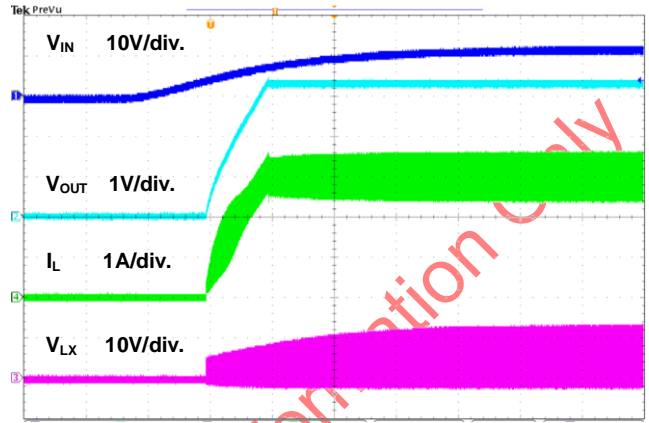

Figure 12. Power On through VIN Waveform

$I_{OUT}=0A$

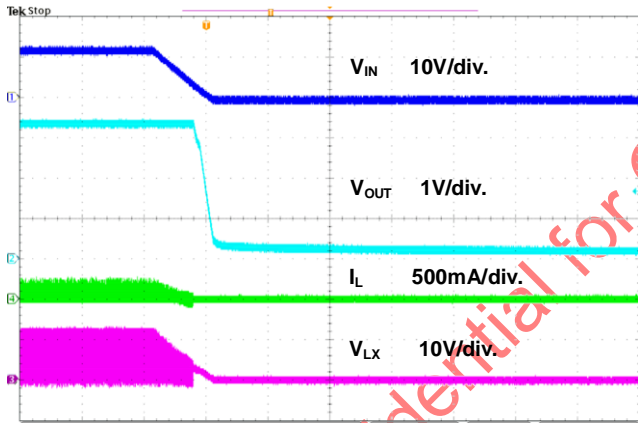

Figure 13. Power Off through VIN Waveform

$I_{OUT}=3A$

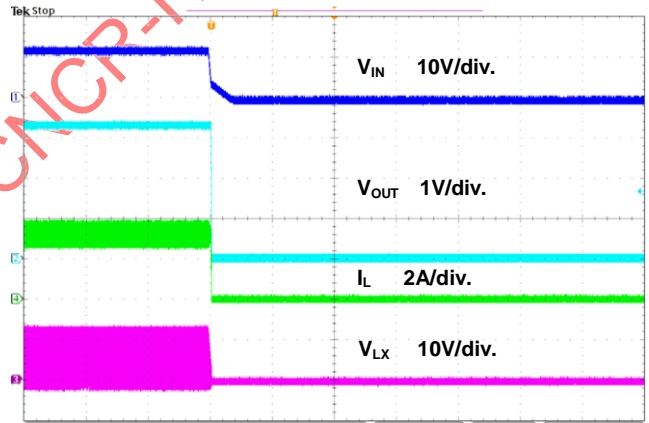

Figure 14. Power Off through VIN Waveform

$I_{OUT}=1A$  to  $3A$



Figure 15. Load Transient Waveform

$I_{OUT}= 3A$

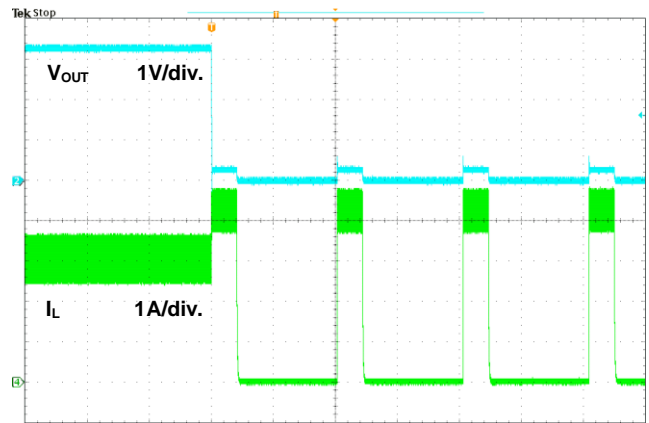

Figure 16. Short Circuit Test

Typical Performance Curves (Continued)

$V_{OUT}=1.2V$

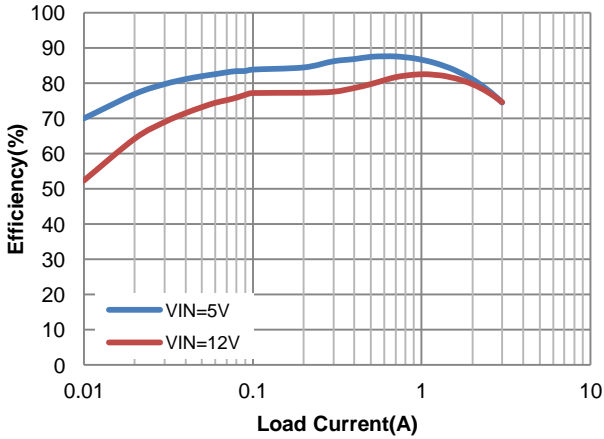

Figure 17. Efficiency vs. Load Current

$V_{OUT}=3.3V$

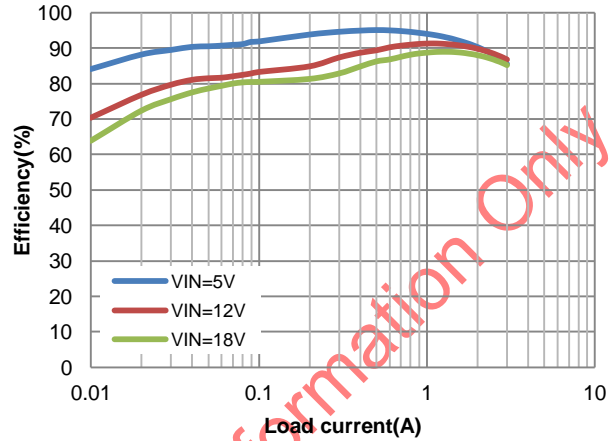

Figure 18. Efficiency vs. Load Current

$V_{OUT}=5V$

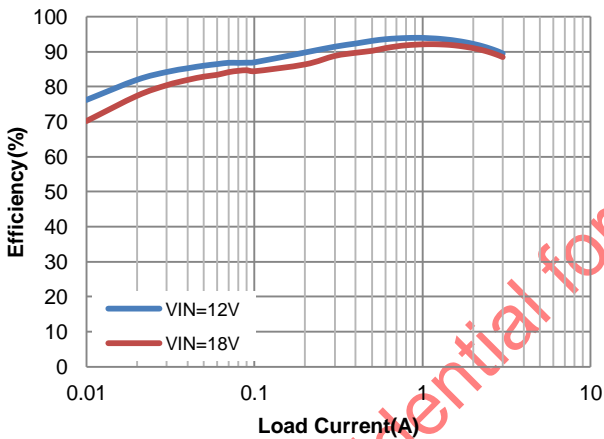

Figure 19. Efficiency vs. Load Current

$I_{OUT}=600mA$

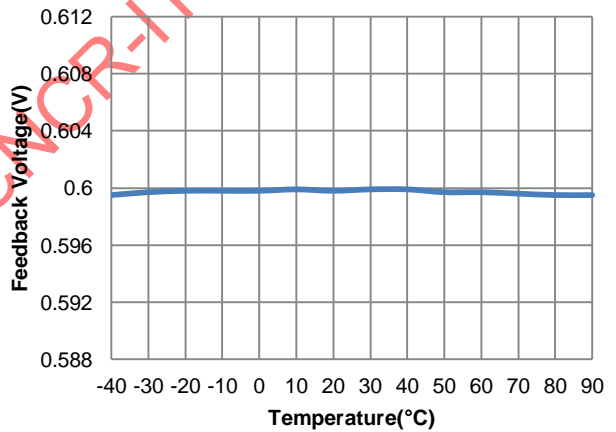

Figure 20. Feedback Voltage vs. Temperature

$I_{OUT}=600mA$

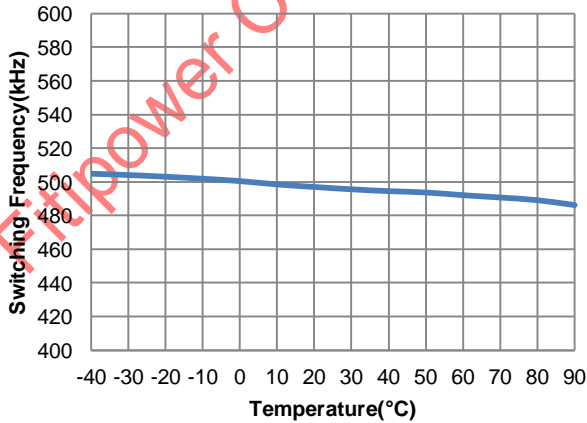

Figure 21. Switching Frequency vs. Temperature



## Function Description

The FR8205 is a high efficiency, internal compensation, and constant frequency current mode step-down synchronous DC/DC converter. It has integrated high-side (90mΩ, typ) and low-side (50mΩ, typ) power switches, and provides 3A continuous load current. It regulates input voltage from 4.5V to 18V, and down to an output voltage as low as 0.6V.

### Control Loop

Under normal operation, the output voltage is sensed by FB pin through a resistive voltage divider and amplified through the error amplifier. The voltage of error amplifier output is compared to the switch current to control the RS latch. At the beginning of each clock cycle, the high-side NMOS turns on when the oscillator sets the RS latch, and turns off when current comparator resets the RS latch. Then the low-side NMOS turns on until the clock period ends.

### Internal Compensation Function

The stability of the feedback circuit is controlled through internal compensation circuits. This internal compensation function is optimized for most applications and this function can reduce external R, C components.

### Enable

The FR8205  $\overline{\text{SHDN}}$  pin provides digital control to turn on/turn off the regulator. When the voltage of  $\overline{\text{SHDN}}$  exceeds the threshold voltage, the regulator starts the soft start function. If the  $\overline{\text{SHDN}}$  pin voltage is below than the shutdown threshold voltage, the regulator will turn into the shutdown mode and the shutdown current will be smaller than 1μA. For auto start-up operation, connect  $\overline{\text{SHDN}}$  to VIN through a 100kΩ resistor.

### Soft Start

The FR8205 employs internal soft start function to reduce input inrush current during start up. The typical value of internal soft start time is 2ms.

### Input Under Voltage Lockout

When the FR8205 is power on, the internal circuits are held inactive until  $V_{\text{IN}}$  voltage exceeds the input UVLO threshold voltage. And the regulator will be disabled when  $V_{\text{IN}}$  is below the input UVLO threshold voltage. The hysteric of the UVLO comparator is 400mV (typ).

### Over Current Protection

The FR8205 over current protection function is implemented using cycle-by-cycle current limit architecture. The inductor current is monitored by measuring the high-side MOSFET series sense resistor voltage. When the load current increases, the inductor current also increases. When the peak inductor current reaches the current limit threshold, the output voltage starts to drop. When the over current condition is removed, the output voltage returns to the regulated value.

### Short Circuit Protection

The FR8205 provides short circuit protection function to prevent the device damage from short condition. When the short condition occurs and the feedback voltage drops lower than 0.4V, the oscillator frequency will be reduced to 150kHz and hiccup mode will be triggered to prevent the inductor current increasing beyond the current limit. Once the short condition is removed, the frequency will return to normal.

### Over Temperature Protection

The FR8205 incorporates an over temperature protection circuit to protect itself from overheating. When the junction temperature exceeds the thermal shutdown threshold temperature, the regulator will be shutdown. And the hysteric of the over temperature protection is 30°C (typ).

## Application Information

### Output Voltage Setting

The output voltage  $V_{OUT}$  is set using a resistive divider from the output to FB. The FB pin regulated voltage is 0.6V. Thus the output voltage is:

$$V_{OUT} = 0.6V \times \left(1 + \frac{R1}{R2}\right)$$

Table 2 lists recommended values of R1 and R2 for most used output voltage.

**Table 2 Recommended Resistance Values**

$V_{OUT}$	R1	R2
5V	30.9k $\Omega$	4.22k $\Omega$
3.3V	30k $\Omega$	6.65k $\Omega$
2.5V	30.9k $\Omega$	9.76k $\Omega$
1.8V	30.9k $\Omega$	15.4k $\Omega$
1.2V	4.99k $\Omega$	4.99k $\Omega$

Place resistors R1 and R2 close to FB pin to prevent stray pickup.

### Input Capacitor Selection

The use of the input capacitor is filtering the input voltage ripple and the MOSFETS switching spike voltage. Because the input current to the step-down converter is discontinuous, the input capacitor is required to supply the current to the converter to keep the DC input voltage. The capacitor voltage rating should be 1.25 to 1.5 times greater than the maximum input voltage. The input capacitor ripple current RMS value is calculated as:

$$I_{CIN(RMS)} = I_{OUT} \times \sqrt{D \times (1-D)}$$

$$D = \frac{V_{OUT}}{V_{IN}}$$

Where D is the duty cycle of the power MOSFET.

This function reaches the maximum value at  $D=0.5$  and the equivalent RMS current is equal to  $I_{OUT}/2$ . The following diagram is the graphical representation of above equation.

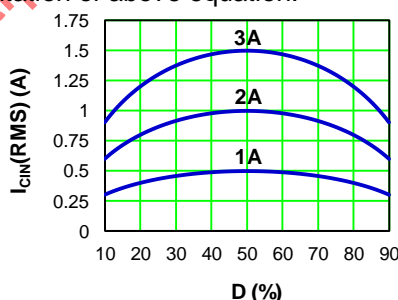

A low ESR capacitor is required to keep the noise minimum. Ceramic capacitors are better, but tantalum or low ESR electrolytic capacitors may also suffice. When using tantalum or electrolytic capacitors, a 0.1 $\mu$ F ceramic capacitor should be placed as close to the IC as possible.

### Output Capacitor Selection

The output capacitor is used to keep the DC output voltage and supply the load transient current. When operating in constant current mode, the output ripple is determined by four components:

$$V_{RIPPLE}(t) = V_{RIPPLE(C)}(t) + V_{RIPPLE(ESR)}(t) + V_{RIPPLE(ESL)}(t) + V_{NOISE}(t)$$

The following figures show the form of the ripple contributions.

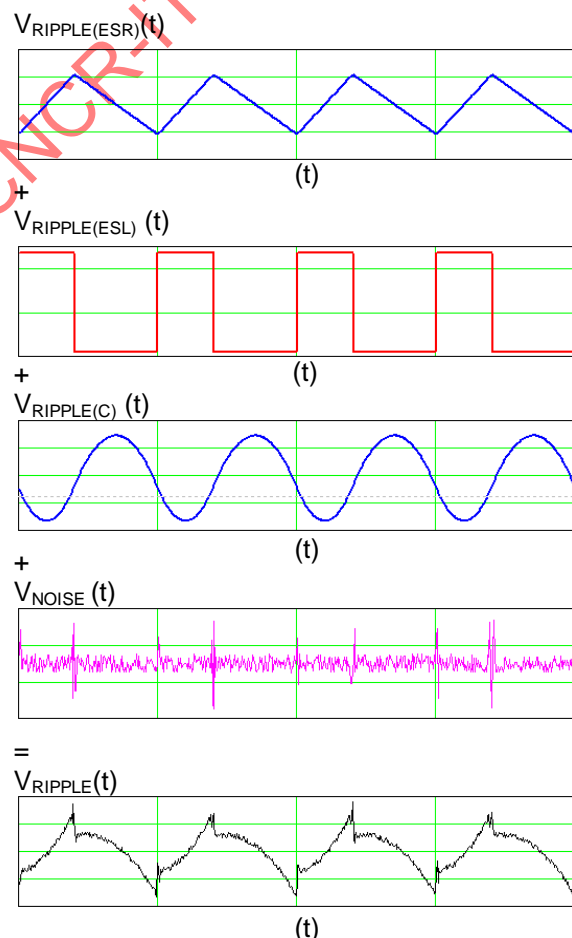

## Application Information (Continued)

$$V_{\text{RIPPLE(ESR)}} = \frac{V_{\text{OUT}}}{F_{\text{OSC}} \times L} \times \left(1 - \frac{V_{\text{OUT}}}{V_{\text{IN}}}\right) \times \text{ESR}$$

$$V_{\text{RIPPLE(ESL)}} = \frac{\text{ESL}}{L + \text{ESL}} \times V_{\text{IN}}$$

$$V_{\text{RIPPLE(C)}} = \frac{V_{\text{OUT}}}{8 \times F_{\text{OSC}}^2 \times L \times C_{\text{OUT}}} \times \left(1 - \frac{V_{\text{OUT}}}{V_{\text{IN}}}\right)$$

Where  $F_{\text{OSC}}$  is the switching frequency,  $L$  is the inductance value,  $V_{\text{IN}}$  is the input voltage,  $\text{ESR}$  is the equivalent series resistance value of the output capacitor,  $\text{ESL}$  is the equivalent series inductance value of the output capacitor and the  $C_{\text{OUT}}$  is the output capacitor.

Low ESR capacitors are preferred to use. Ceramic, tantalum or low ESR electrolytic capacitors can be used depending on the output ripple requirement. When using the ceramic capacitors, the ESL component is usually negligible.

It is important to use the proper method to eliminate high frequency noise when measuring the output ripple. The figure shows how to locate the probe across the capacitor when measuring output ripple. Removing the scope probe plastic jacket in order to expose the ground at the tip of the probe. It gives a very short connection from the probe ground to the capacitor and eliminating noise.

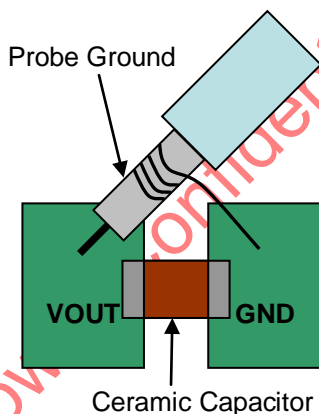

### Inductor Selection

The output inductor is used for storing energy and filtering output ripple current. But the trade-off condition often happens between maximum energy storage and the physical size of the inductor. The first consideration for selecting the output inductor is to make sure that the inductance is large enough to keep the converter in the continuous current mode.

That will lower ripple current and result in lower output ripple voltage. The  $\Delta I_L$  is inductor peak-to-peak ripple current:

$$\Delta I_L = \frac{V_{\text{OUT}}}{F_{\text{OSC}} \times L} \times \left(1 - \frac{V_{\text{OUT}}}{V_{\text{IN}}}\right)$$

The following diagram is an example to graphical represent  $\Delta I_L$  equation.

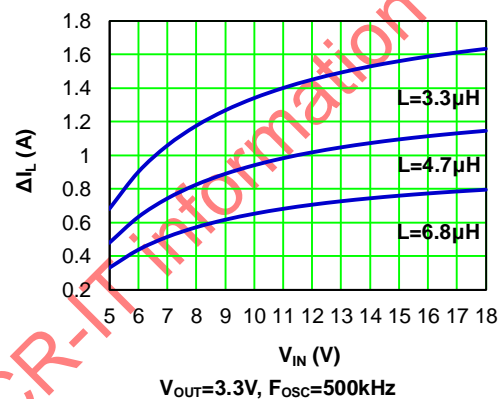

A good compromise value between size and efficiency is to set the peak-to-peak inductor ripple current  $\Delta I_L$  equal to 30% of the maximum load current. But setting the peak-to-peak inductor ripple current  $\Delta I_L$  between 20%~50% of the maximum load current is also acceptable. Then the inductance can be calculated with the following equation:

$$\Delta I_L = 0.3 \times I_{\text{OUT(MAX)}}$$

$$L = \frac{(V_{\text{IN}} - V_{\text{OUT}}) \times V_{\text{OUT}}}{V_{\text{IN}} \times F_{\text{OSC}} \times \Delta I_L}$$

To guarantee sufficient output current, peak inductor current must be lower than the FR8205 high-side MOSFET current limit. The peak inductor current is as below:

$$I_{\text{PEAK}} = I_{\text{OUT(MAX)}} + \frac{\Delta I_L}{2}$$

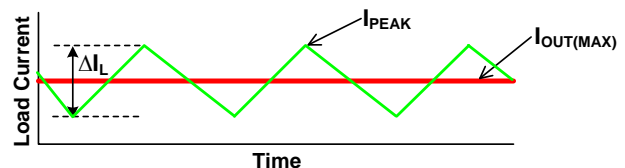

## Application Information (Continued)

### Feedforward Capacitor Selection

Internal compensation function allows users saving time in design and saving cost by reducing the number of external components. The use of a feedforward capacitor C4 in the feedback network is recommended to improve the transient response or higher phase margin.

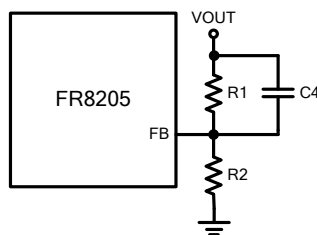

For optimizing the feedforward capacitor, knowing the cross frequency is the first thing. The cross frequency (or the converter bandwidth) can be determined by using a network analyzer. When getting the cross frequency with no feedforward capacitor identified, the value of feedforward capacitor C4 can be calculated with the following equation:

$$C4 = \frac{1}{2\pi \times F_{CROSS}} \times \sqrt{\frac{1}{R1} \times \left( \frac{1}{R1} + \frac{1}{R2} \right)}$$

Where  $F_{CROSS}$  is the cross frequency.

To reduce transient ripple, the feedforward capacitor value can be increased to push the cross frequency to higher region. Although this can improve transient response, it also decrease phase margin and cause more ringing. In the other hand, if more phase margin is desired, the feedforward capacitor value can be decreased to push the cross frequency to lower region. In general, the feedforward capacitor range is between 10pF to 10nF.

### External Diode Selection

For 5V input applications, it is recommended to add an external boost diode. This helps improving the efficiency. The boost diode can be a low cost one such as 1N4148.

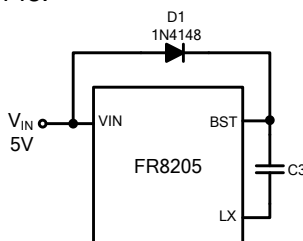

### PCB Layout Recommendation

The device's performance and stability is dramatically affected by PCB layout. It is recommended to follow these general guidelines shown as below:

1. Place the input capacitors and output capacitors as close to the device as possible. Trace to these capacitors should be as short and wide as possible to minimize parasitic inductance and resistance.
2. Place feedback resistors close to the FB pin.
3. Keep the sensitive signal (FB) away from the switching signal (LX).
4. Multi-layer PCB design is recommended.

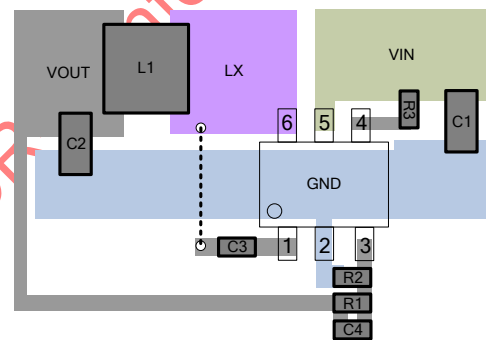
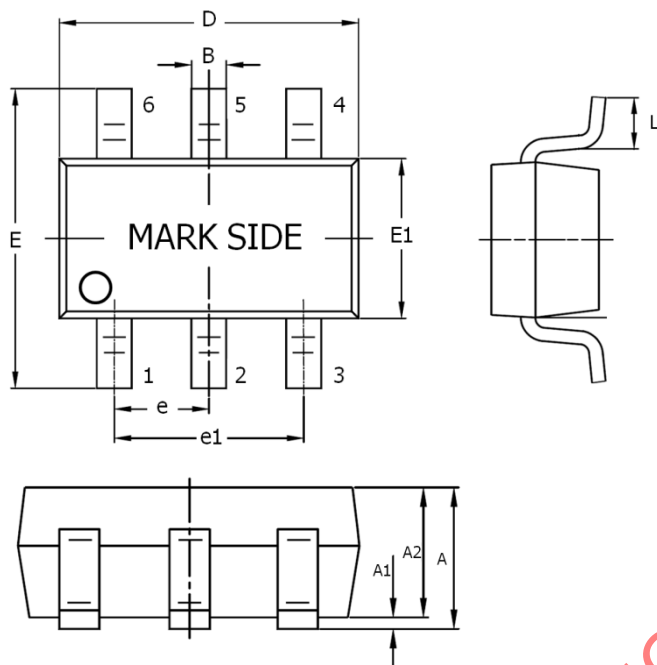

Figure 22. Recommended PCB Layout Diagram

Outline Information

FC-SOT-23-6 Package (Unit: mm)



SYMBOLS UNIT	DIMENSION IN MILLIMETER	
	MIN	MAX
A	0.80	1.45
A1	0.00	0.15
A2	0.80	1.30
B	0.30	0.50
D	2.80	3.00
E	2.60	3.00
E1	1.50	1.70
e	0.90	1.00
e1	1.80	2.00
L	0.30	0.60

Note 1: Followed From JEDEC MO-178-C.

Carrier dimensions

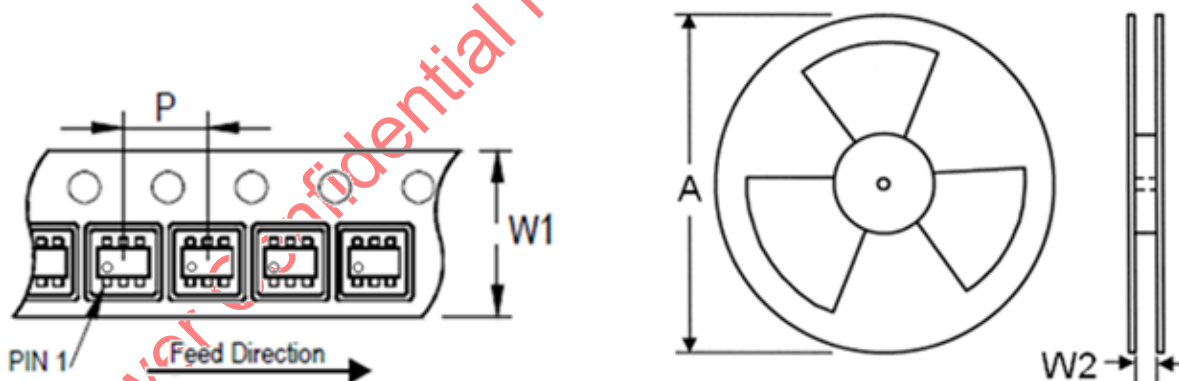

Tape Size (W1) mm	Pocket Pitch (P) mm	Reel Size (A)		Reel Width (W2) mm	Empty Cavity Length mm	Units per Reel
		in	mm			
8	4	7	180	8.4	300~1000	3,000

Life Support Policy

Fitipower's products are not authorized for use as critical components in life support devices or other medical systems.