

# FS100KMJ-03

HIGH-SPEED SWITCHING USE

## FS100KMJ-03



- 4V DRIVE
- V<sub>DSS</sub> ..... 30V
- r<sub>DS (ON)</sub> (MAX) ..... 4.7mΩ
- I<sub>D</sub> ..... 100A
- Integrated Fast Recovery Diode (TYP.) ..... 100ns
- V<sub>iso</sub> ..... 2000V

## OUTLINE DRAWING

Dimensions in mm

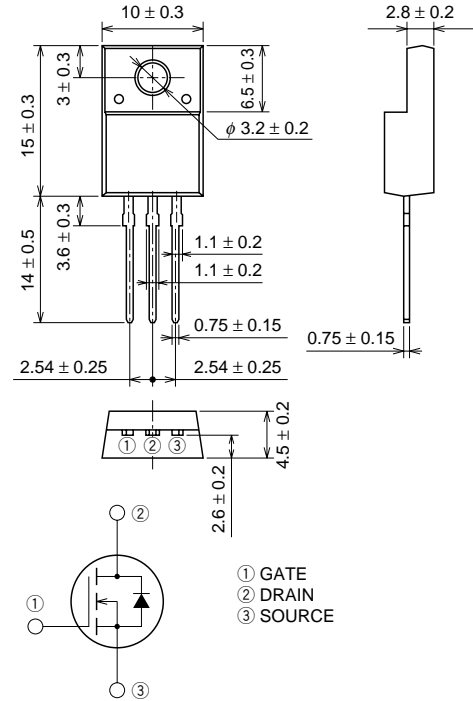

TO-220FN

## APPLICATION

Motor control, Lamp control, Solenoid control  
DC-DC converter, etc.

## MAXIMUM RATINGS (T<sub>c</sub> = 25°C)

Symbol	Parameter	Conditions	Ratings	Unit
V <sub>DSS</sub>	Drain-source voltage	V <sub>GS</sub> = 0V	30	V
V <sub>GSS</sub>	Gate-source voltage	V <sub>DS</sub> = 0V	±20	V
I <sub>D</sub>	Drain current		100	A
I <sub>DM</sub>	Drain current (Pulsed)		400	A
I <sub>DA</sub>	Avalanche drain current (Pulsed)	L = 30μH	100	A
I <sub>S</sub>	Source current		100	A
I <sub>SM</sub>	Source current (Pulsed)		400	A
P <sub>D</sub>	Maximum power dissipation		35	W
T <sub>ch</sub>	Channel temperature		-55 ~ +150	°C
T <sub>stg</sub>	Storage temperature		-55 ~ +150	°C
V <sub>iso</sub>	Isolation voltage	AC for 1minute, Terminal to case	2000	V
—	Weight	Typical value	2.0	g

**ELECTRICAL CHARACTERISTICS** (Tch = 25°C)

Symbol	Parameter	Test conditions	Limits			Unit
			Min.	Typ.	Max.	
V (BR) DSS	Drain-source breakdown voltage	Id = 1mA, Vgs = 0V	30	—	—	V
IgSS	Gate-source leakage current	Vgs = ±20V, Vds = 0V	—	—	±0.1	μA
IbSS	Drain-source leakage current	Vds = 30V, Vgs = 0V	—	—	0.1	mA
VGS (th)	Gate-source threshold voltage	Id = 1mA, Vds = 10V	1.0	1.5	2.0	V
rDS (ON)	Drain-source on-state resistance	Id = 50A, Vgs = 10V	—	3.5	4.7	mΩ
rDS (ON)	Drain-source on-state resistance	Id = 50A, Vgs = 4V	—	4.7	8.0	mΩ
VDS (ON)	Drain-source on-state voltage	Id = 50A, Vgs = 10V	—	0.175	0.235	V
yfs	Forward transfer admittance	Id = 50A, Vds = 10V	—	80	—	S
Ciss	Input capacitance	Vds = 10V, Vgs = 0V, f = 1MHz	—	8000	—	pF
Coss	Output capacitance		—	2250	—	pF
Crss	Reverse transfer capacitance		—	1300	—	pF
td (on)	Turn-on delay time	VDD = 15V, Id = 50A, Vgs = 10V, RGEN = RGS = 50Ω	—	55	—	ns
tr	Rise time		—	190	—	ns
td (off)	Turn-off delay time		—	800	—	ns
tf	Fall time		—	470	—	ns
VSD	Source-drain voltage	Is = 50A, Vgs = 0V	—	1.0	1.5	V
Rth (ch-c)	Thermal resistance	Channel to case	—	—	3.57	°C/W
trr	Reverse recovery time	Is = 50A, dis/dt = -50A/μs	—	100	—	ns

**PERFORMANCE CURVES**

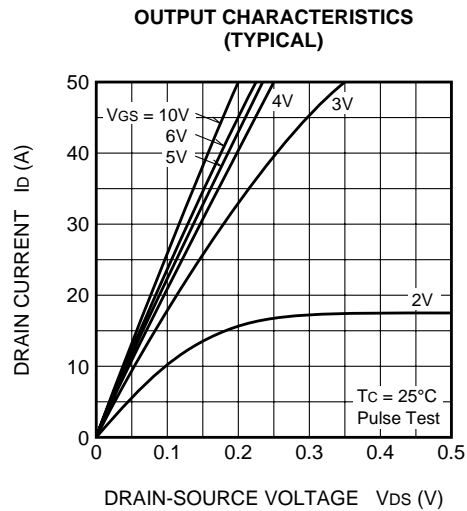
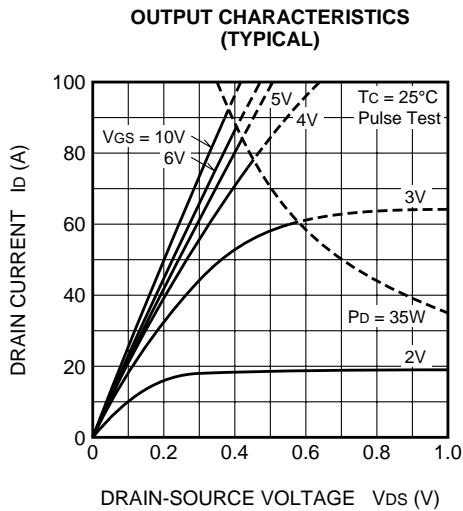
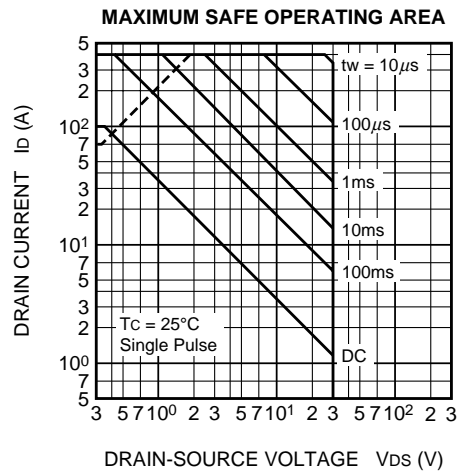
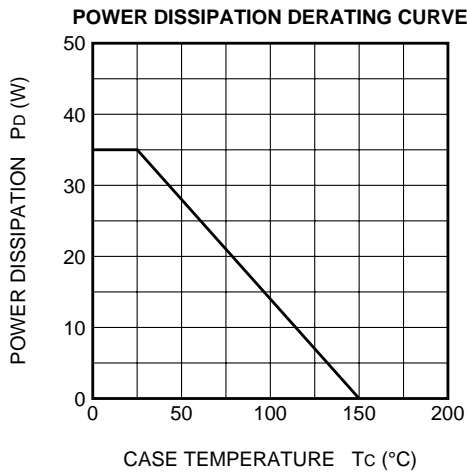

# FS100KMJ-03

## HIGH-SPEED SWITCHING USE

**ON-STATE VOLTAGE VS. GATE-SOURCE VOLTAGE (TYPICAL)**

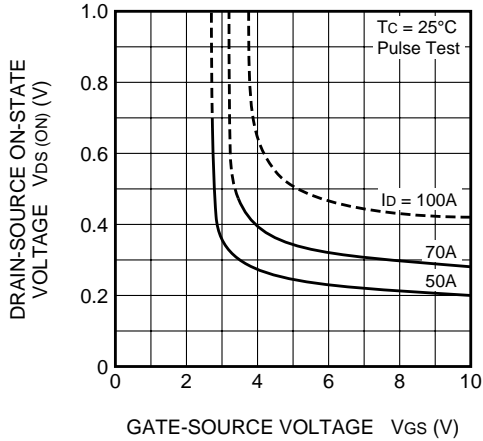

**ON-STATE RESISTANCE VS. DRAIN CURRENT (TYPICAL)**

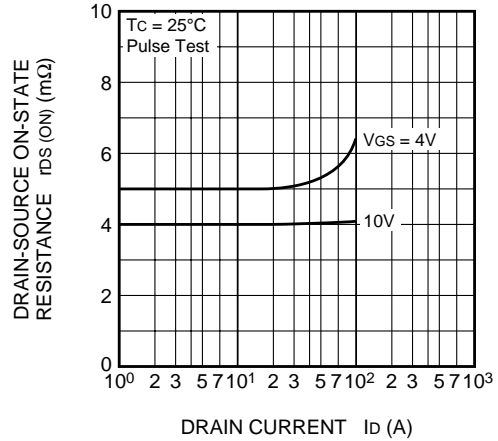

**TRANSFER CHARACTERISTICS (TYPICAL)**

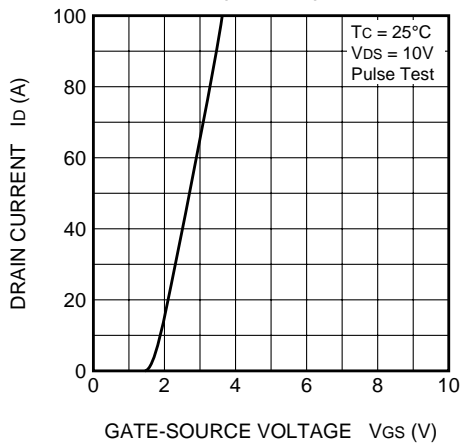

**FORWARD TRANSFER ADMITTANCE VS. DRAIN CURRENT (TYPICAL)**

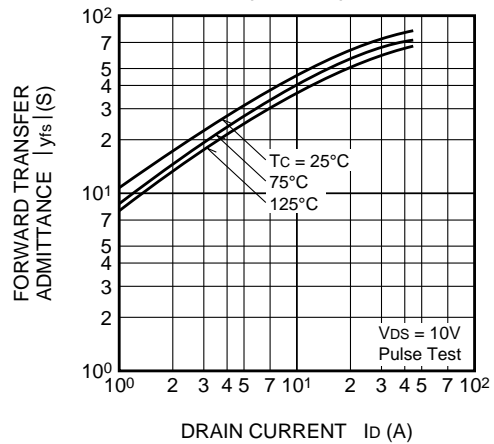

**CAPACITANCE VS. DRAIN-SOURCE VOLTAGE (TYPICAL)**

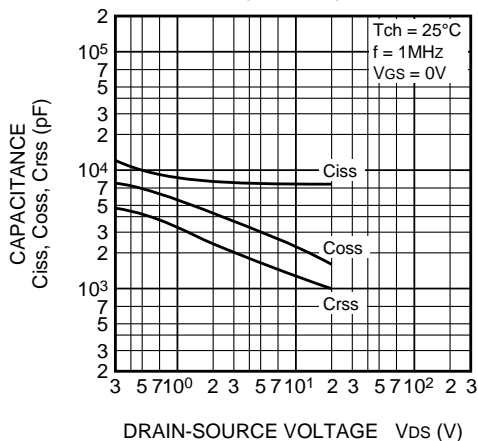

**SWITCHING CHARACTERISTICS (TYPICAL)**

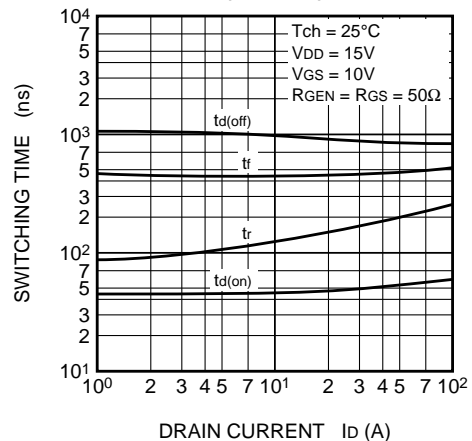

**GATE-SOURCE VOLTAGE VS. GATE CHARGE (TYPICAL)**

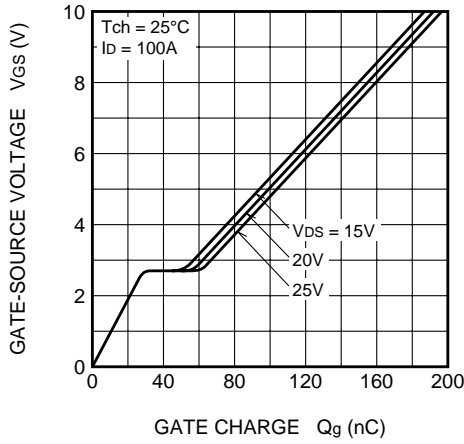

**SOURCE-DRAIN DIODE FORWARD CHARACTERISTICS (TYPICAL)**

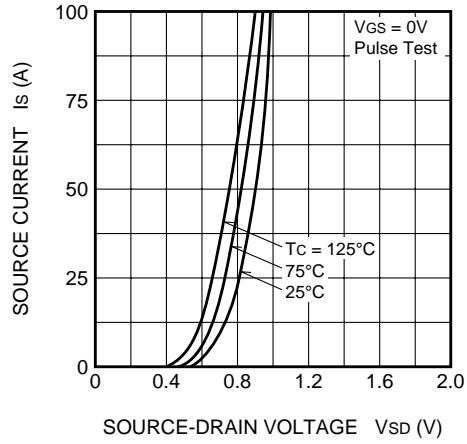

**ON-STATE RESISTANCE VS. CHANNEL TEMPERATURE (TYPICAL)**

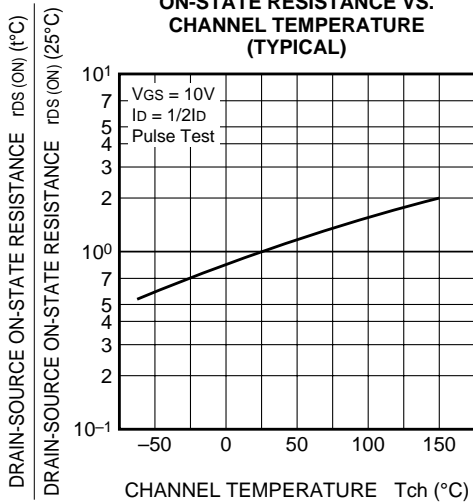

**THRESHOLD VOLTAGE VS. CHANNEL TEMPERATURE (TYPICAL)**

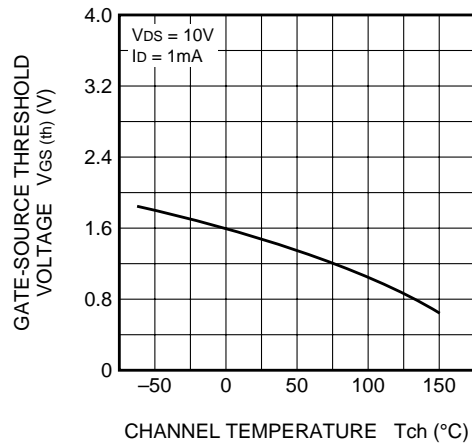

**BREAKDOWN VOLTAGE VS. CHANNEL TEMPERATURE (TYPICAL)**

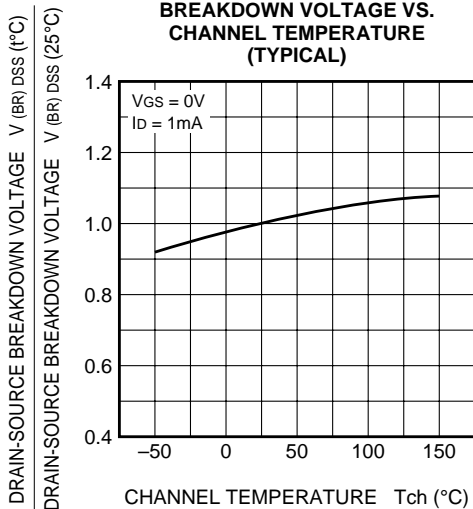

**TRANSIENT THERMAL IMPEDANCE CHARACTERISTICS**

