

# FS70UMJ-03

HIGH-SPEED SWITCHING USE

## FS70UMJ-03



- 4V DRIVE
- V<sub>DSS</sub> ..... 30V
- r<sub>DS (ON)</sub> (MAX) ..... 12mΩ
- I<sub>D</sub> ..... 70A
- Integrated Fast Recovery Diode (TYP.) ..... 70ns

## OUTLINE DRAWING

Dimensions in mm

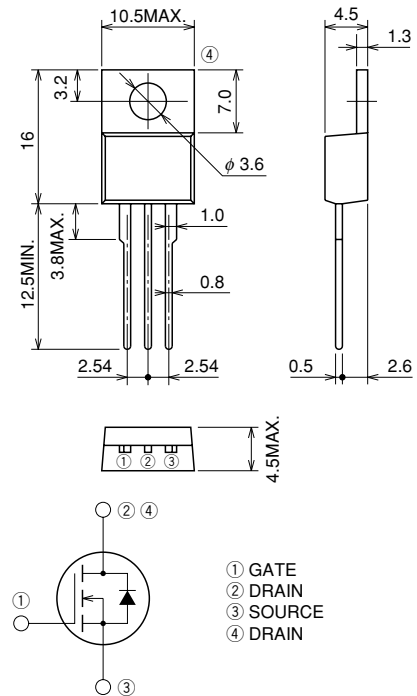

TO-220

## APPLICATION

Motor control, Lamp control, Solenoid control  
DC-DC converter, etc.

## MAXIMUM RATINGS (T<sub>c</sub> = 25°C)

Symbol	Parameter	Conditions	Ratings	Unit
V <sub>DSS</sub>	Drain-source voltage	V <sub>GS</sub> = 0V	30	V
V <sub>GSS</sub>	Gate-source voltage	V <sub>DS</sub> = 0V	±20	V
I <sub>D</sub>	Drain current		70	A
I <sub>DM</sub>	Drain current (Pulsed)		280	A
I <sub>DA</sub>	Avalanche drain current (Pulsed)	L = 30μH	70	A
I <sub>S</sub>	Source current		70	A
I <sub>SM</sub>	Source current (Pulsed)		280	A
P <sub>D</sub>	Maximum power dissipation		70	W
T <sub>ch</sub>	Channel temperature		-55 ~ +150	°C
T <sub>stg</sub>	Storage temperature		-55 ~ +150	°C
—	Weight	Typical value	2.0	g

**ELECTRICAL CHARACTERISTICS** (T<sub>ch</sub> = 25°C)

Symbol	Parameter	Test conditions	Limits			Unit
			Min.	Typ.	Max.	
V <sub>(BR)DSS</sub>	Drain-source breakdown voltage	I <sub>D</sub> = 1mA, V <sub>GS</sub> = 0V	30	—	—	V
I <sub>GSS</sub>	Gate-source leakage current	V <sub>GS</sub> = ±20V, V <sub>DS</sub> = 0V	—	—	±0.1	μA
I <sub>DSS</sub>	Drain-source leakage current	V <sub>DS</sub> = 30V, V <sub>GS</sub> = 0V	—	—	0.1	mA
V <sub>GS(th)</sub>	Gate-source threshold voltage	I <sub>D</sub> = 1mA, V <sub>DS</sub> = 10V	1.0	1.5	2.0	V
r <sub>DS(ON)</sub>	Drain-source on-state resistance	I <sub>D</sub> = 35A, V <sub>GS</sub> = 10V	—	9	12	mΩ
r <sub>DS(ON)</sub>	Drain-source on-state resistance	I <sub>D</sub> = 35A, V <sub>GS</sub> = 4V	—	13	22	mΩ
V <sub>DS(ON)</sub>	Drain-source on-state voltage	I <sub>D</sub> = 35A, V <sub>GS</sub> = 10V	—	0.32	0.42	V
y <sub>fs</sub>	Forward transfer admittance	I <sub>D</sub> = 35A, V <sub>DS</sub> = 10V	—	50	—	S
C <sub>iss</sub>	Input capacitance	V <sub>DS</sub> = 10V, V <sub>GS</sub> = 0V, f = 1MHz	—	2850	—	pF
C <sub>oss</sub>	Output capacitance		—	800	—	pF
C <sub>rss</sub>	Reverse transfer capacitance		—	450	—	pF
t <sub>d(on)</sub>	Turn-on delay time	V <sub>DD</sub> = 15V, I <sub>D</sub> = 35A, V <sub>GS</sub> = 10V, R <sub>GEN</sub> = R <sub>GS</sub> = 50Ω	—	25	—	ns
t <sub>r</sub>	Rise time		—	125	—	ns
t <sub>d(off)</sub>	Turn-off delay time		—	250	—	ns
t <sub>f</sub>	Fall time		—	210	—	ns
V <sub>SD</sub>	Source-drain voltage	I <sub>S</sub> = 35A, V <sub>GS</sub> = 0V	—	1.0	1.5	V
R <sub>th(ch-c)</sub>	Thermal resistance	Channel to case	—	—	1.76	°C/W
t <sub>rr</sub>	Reverse recovery time	I <sub>S</sub> = 35A, di <sub>s</sub> /dt = -50A/μs	—	70	—	ns

**PERFORMANCE CURVES**

**POWER DISSIPATION DERATING CURVE**

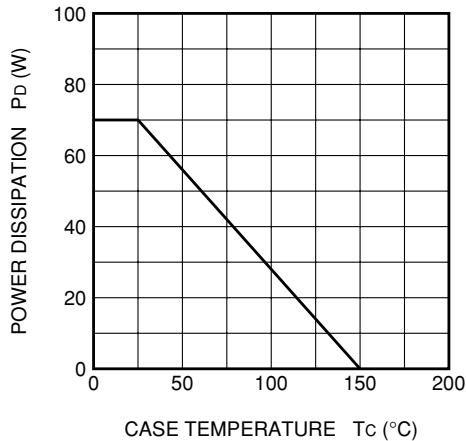

**MAXIMUM SAFE OPERATING AREA**

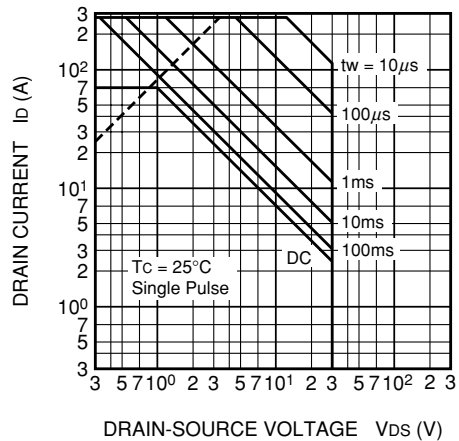

**OUTPUT CHARACTERISTICS (TYPICAL)**

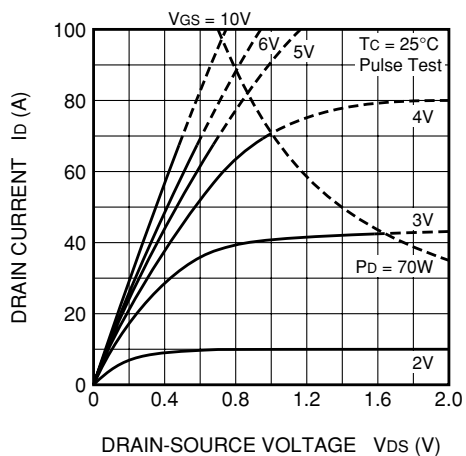

**OUTPUT CHARACTERISTICS (TYPICAL)**

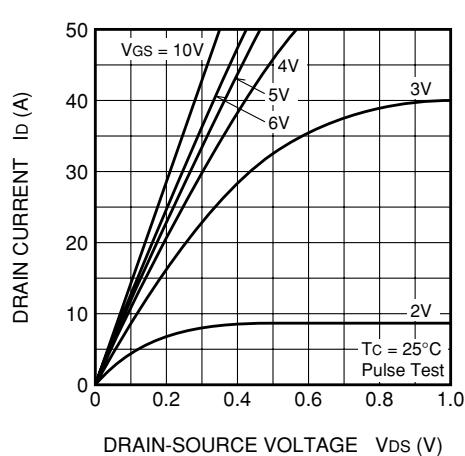

ON-STATE VOLTAGE VS. GATE-SOURCE VOLTAGE (TYPICAL)

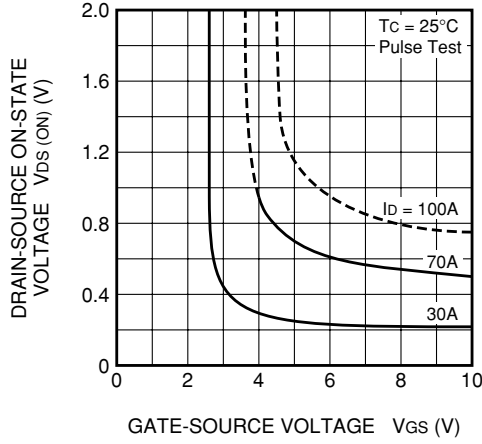

ON-STATE RESISTANCE VS. DRAIN CURRENT (TYPICAL)

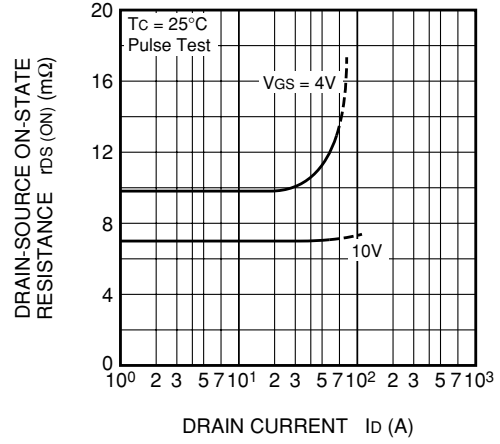

TRANSFER CHARACTERISTICS (TYPICAL)

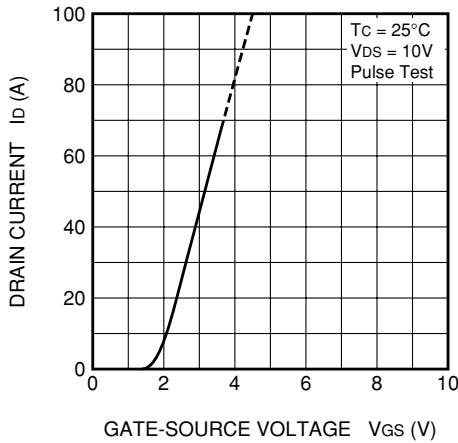

FORWARD TRANSFER ADMITTANCE VS. DRAIN CURRENT (TYPICAL)

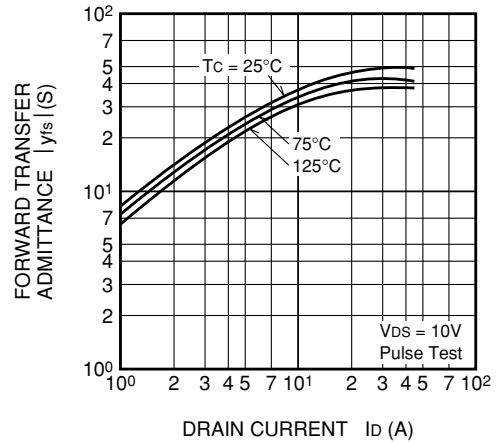

CAPACITANCE VS. DRAIN-SOURCE VOLTAGE (TYPICAL)

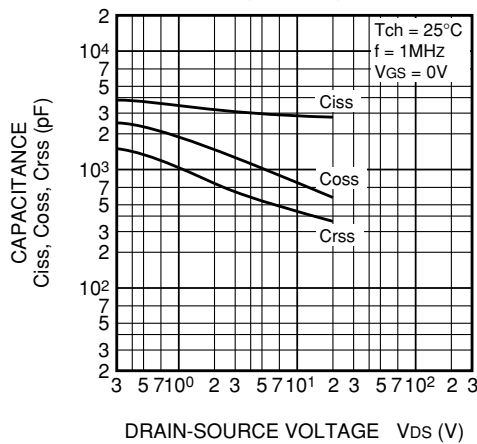

SWITCHING CHARACTERISTICS (TYPICAL)

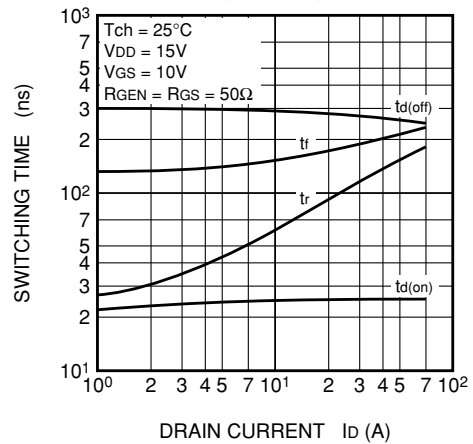

**GATE-SOURCE VOLTAGE VS. GATE CHARGE (TYPICAL)**

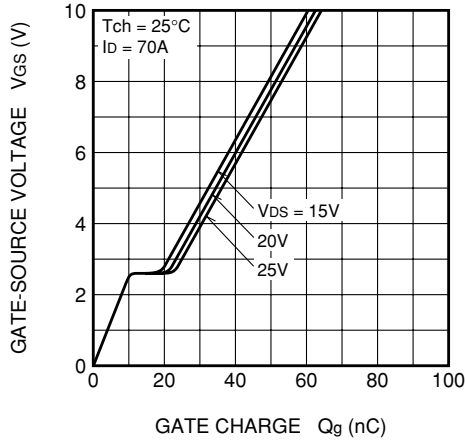

**SOURCE-DRAIN DIODE FORWARD CHARACTERISTICS (TYPICAL)**

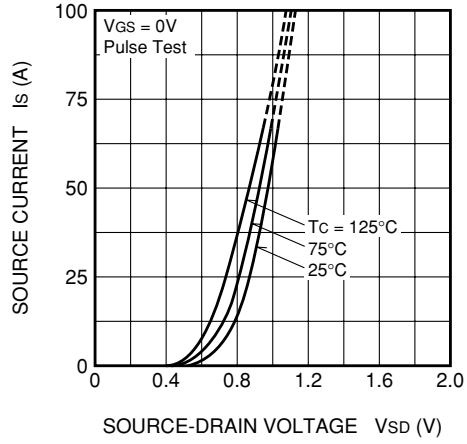

**ON-STATE RESISTANCE VS. CHANNEL TEMPERATURE (TYPICAL)**

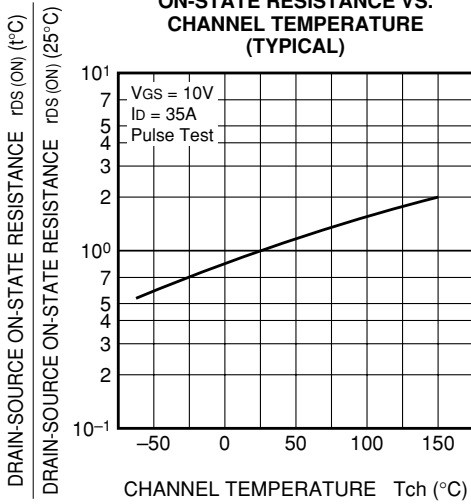

**THRESHOLD VOLTAGE VS. CHANNEL TEMPERATURE (TYPICAL)**

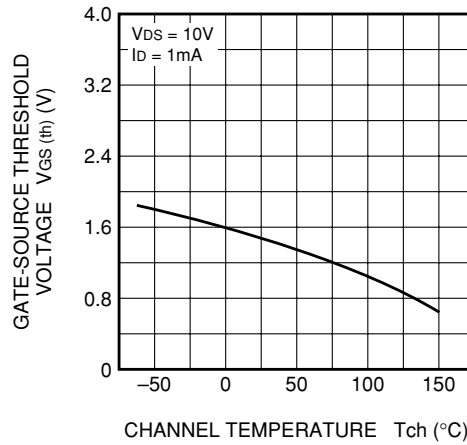

**BREAKDOWN VOLTAGE VS. CHANNEL TEMPERATURE (TYPICAL)**

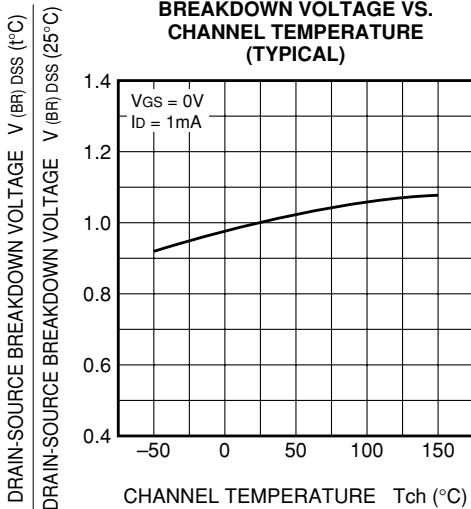

**TRANSIENT THERMAL IMPEDANCE CHARACTERISTICS**

