

Datasheet

FS8860

1.0A Adjustable & Fixed Voltage LDO Linear Regulator

FORTUNE,
Properties
For Reference Only

Fortune Semiconductor Corporation

富晶電子股份有限公司

23F., No.29-5, Sec. 2, Zhongzheng E. Rd.,
Danshui Dist., New Taipei City 251, Taiwan

Tel. : 886-2-28094742

Fax : 886-2-28094874

www.ic-fortune.com

This manual contains new product information. **Fortune Semiconductor Corporation** reserves the rights to modify the product specification without further notice. No liability is assumed by **Fortune Semiconductor Corporation** as a result of the use of this product. No rights under any patent accompany the sale of the product.

1. General Description

The FS8860 is a low-dropout linear regulator that operates in the input voltage range from +2.5V to +7.0V and delivers 1.0A output current.

The FS8860 is available in two types, fixed output voltage type or adjustable output voltage type. The fixed output voltage type is preset at an internally trimmed voltage 1.8V, or 3.3V. Other options 1.5V, 2.85V, 3.0V and 3.6V are available by special order only. The output voltage range of the adjustable type is from 1.25V to 5V.

The FS8860 consists of a 1.25V bandgap reference, an error amplifier, and a P-channel pass transistor. Other features include short-circuit protection and thermal shutdown protection. The FS8860 devices are available in SOT-223 packages.

2. Features

- Low dropout voltage 700mV at 1.0A typ.
- Adjustable output voltage (FS8860-Cx) or fixed output voltage (FS8860-xxCx) preset at 1.8V, or 3.3V
- High output voltage accuracy
- Fixed output voltage : ±35mV
- Adjustable output voltage : ±50mV
- Small output capacitor
- Output current limit
- Thermal overload shutdown protection
- SOT-223 Packages

3. Applications

- CD-ROM Drivers
- Active SCSI Terminators
- High Efficiency Linear Regulators
- Monitor Microprocessors
- Low Voltage Micro-Controllers
- Post Regulator for Switching Power

Ordering Information

FS8860-xx x x

Package Pin Out
 J : SOT-223 1.GND 2.OUT 3.IN
 Note : For the adjustable voltage types, the GND pin is replaced with the ADJ pin

Package Type
 G : G stands for Green-Package

Output Voltage
 18 : 1.8V 25 : 2.5V
 28 : 2.8V 33 : 3.3V
 36 : 3.6V
VR : Adjustable Output

Note: The output voltages other than the preset values are available by order only.

4. Pin Configurations

Part No.	Pin 1	Pin 2	Pin 3
FS8860-xxGJ	GND/ADJ	OUT (TAP)	IN

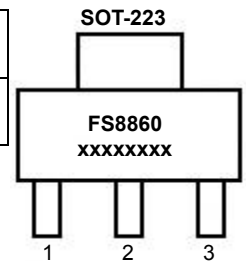

5. Package Marking Information

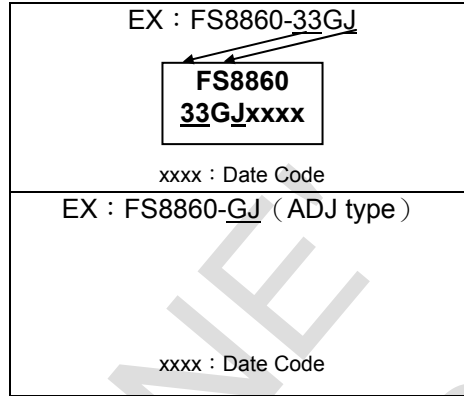

6. Pin Description

Part NO.	Symbol	Description
FS8860-xxGJ	GND/ADJ	Ground pin or adjust terminal pin.
	IN	Regulator input pin.
	OUT	Regulator output pin.

IN is the regulator input pin. Supply voltage can range from 2.5V to 7.0V. An input capacitor is recommended. A 10µF tantalum on the input is a suitable input bypassing for almost all applications.

OUT is the output voltage pin. Sources up to 0.6A. Bypass with a 10µF capacitor to GND. The capacitor from VOUT to GND provides compensation feedback to the internal gain stage. This is to ensure stability at the output terminal. The minimum output capacitance is 10µF tantalum. Any increase of the output capacitance will improve the loop stability and transient response. The output capacitor increasing its value will increase stability. COUT = 100µF or more is typical for high current regulator design.

GND provides the reference for all voltages.

ADJ provides VREF=1.25V (Typ.) for adjustable output voltage.

7. Typical Application Circuit

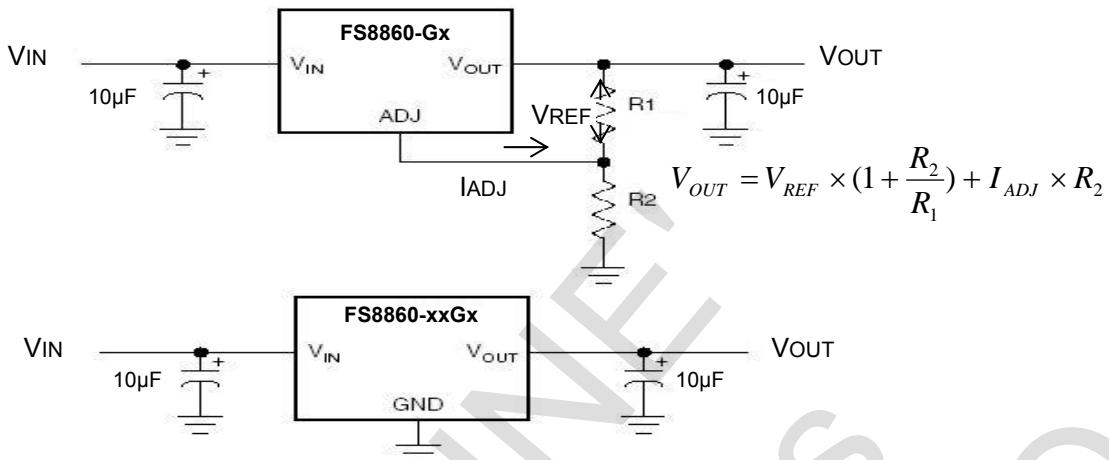

8. Functional Block Diagrams

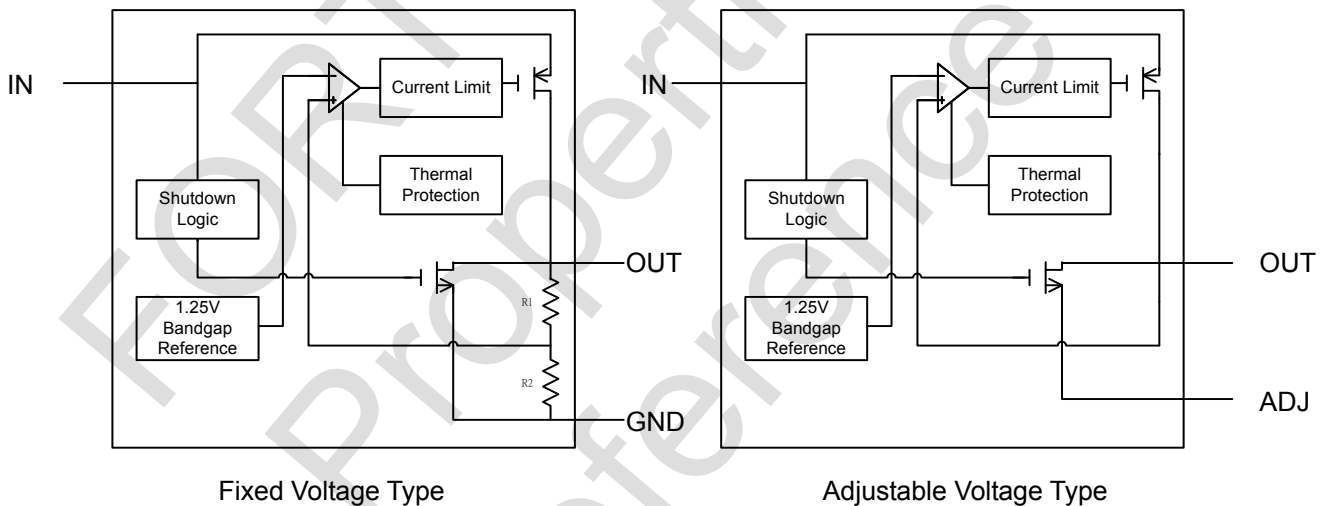

9. Absolute Maximum Ratings

Input voltage V_{IN} to GND	-----	9V
Output current limit, I(LIMIT)	-----	1.3A
Continuous power dissipation	-----	Internally Limited
Junction Temperature, T_J	-----	+155°C
Storage temperature range, T_{STG}	-----	-55°C to +150°C
Operating junction temperature range	-----	-40°C to +125°C
Lead temperature (soldering, 10sec)	-----	260°C

* Stresses beyond those listed under “absolute maximum ratings” may cause permanent damage to the device. These are stress ratings only, and function operation of the device at these or any other conditions beyond those indicated under “recommended operating conditions” is not implied. Exposure to absolute-maximum-rated conditions for extended periods may affect device reliability.

10. Electrical Characteristics

(CIN=10μF, COUT=10μF, TA=25°C, unless otherwise noted.)

Symbol	Parameter	Test Conditions	Min	Typ	Max	Unit
VIN	Input Voltage		2.5		7.0	V
VOUT	Output Voltage	Fixed Voltage Type VIN=VOUT+1.0V, IOUT=1mA	VOUT-0.035	VOUT	VOUT+0.035	V
		Adjustable Voltage Type VIN=VOUT+1.2V, IOUT=1mA	1.238	1.25	1.262	V
Δ VOUT	Output Voltage Accuracy	VIN>VOUT+1.0V, VIN ≤ 7V (Fixed Voltage Type)	-35		+35	mV
		VIN>VOUT+1.2V, VIN ≤ 7V (Adjustable Voltage Type)	-50		+50	mV
IMAX	Maximum Output Current		1.0			A
ILIMIT	Current Limit				1.3	A
ISC	Short-Circuit Current	VOUT=0V	VIN>VOUT+1.0V (Fixed Voltage Type)	650	760	mA
			VIN>VOUT+1.2V (Adjustable Voltage Type)			
IQ	Ground Pin Current	ILOAD=0mA to 1A, VIN=VOUT+1.0V		65	90	μA
IADJ	ADJ Pin Current	ILOAD=0mA to 1A, VIN=VOUT+1.2V		65	90	μA
VDROP	Dropout Voltage (Fixed Output Voltage Version)	IOUT=100mA		60	100	mV
		IOUT=500mA		300	500	mV
		IOUT=1.0A		700	1000	mV
ΔVLINE	Line Regulation	VOUT+1.0V<VIN<7V, ILOAD=1mA (Fixed Voltage Type)		0.2	0.3	%/V
		VOUT+1.2V<VIN<7V, ILOAD=1mA (Adjustable Voltage Type)		0.2	0.3	%/V
ΔVLOAD	Load Regulation	VOUT+1.0V<VIN<7V IOUT=0mA to 1.0A (Fixed Voltage Type)		0.02	0.03	%/mA
		VOUT+1.0V<VIN<7V IOUT=0mA to 1.0A (Adjustable Voltage Type)		0.1	0.15	%/mA
eN	Output Noise	F=1Hz to 10KHz, COUT=10μF		80		μVRMS
PSRR	Ripple Rejection	F=1KHz, COUT=10μF		70		dB
TSD	Thermal Shutdown Temperature			155		°C
THYS	Thermal Shutdown Hysteresis			20		°C
θJA	Thermal Resistance (No heat-sink, No air flow)	SOT-223		155		°C/W

11. Typical Operating Characteristics

(CIN=10μF, COUT=10μF, TA=+25°C, unless otherwise noted.)

OUTPUT VOLTAGE vs. INPUT VOLTAGE

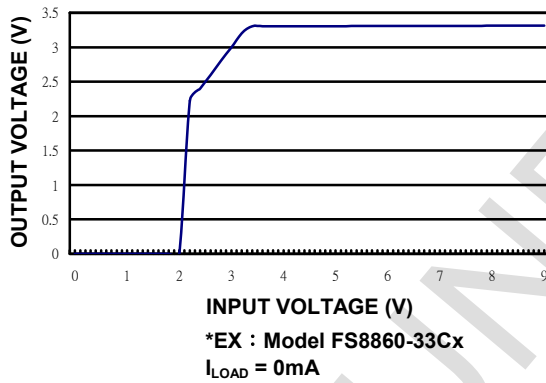

GROUND PIN CURRENT vs. AMBIENT TEMPERATURE

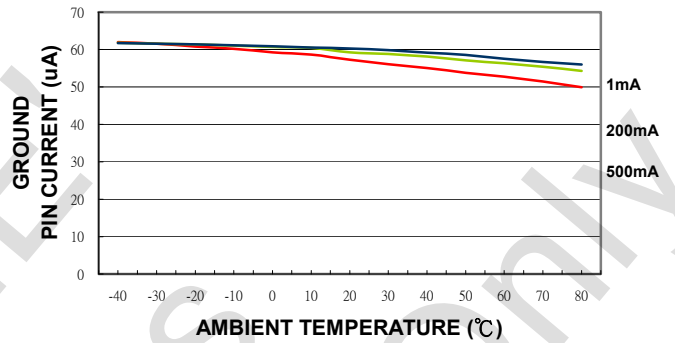

DROPOUT VOLTAGE vs. LOAD CURRENT

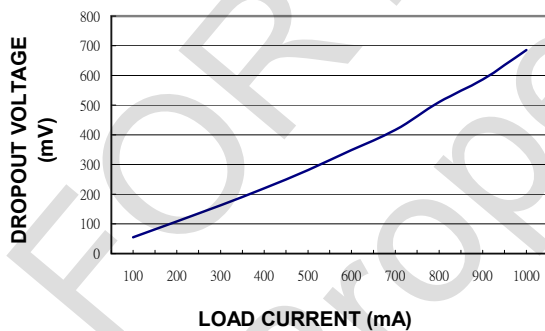

Ron vs. LOAD CURRENT

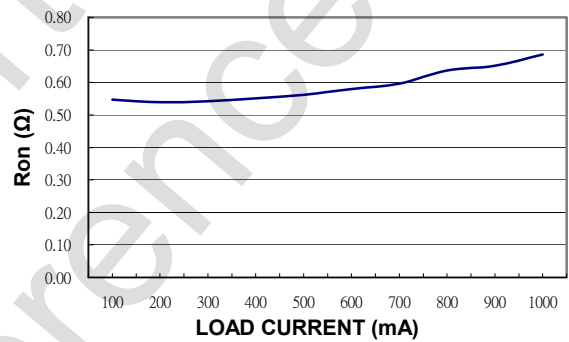

POWER SUPPLY REJECTION RATIO vs FREQUENCY

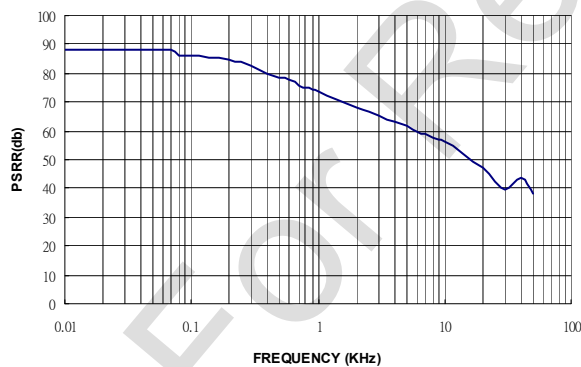

GROUND PIN CURRENT vs. LOAD CURRENT

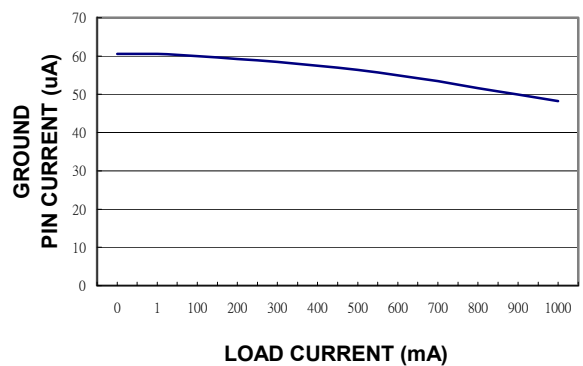

OUTPUT VOLTAGE vs. AMBIENT TEMPERATURE

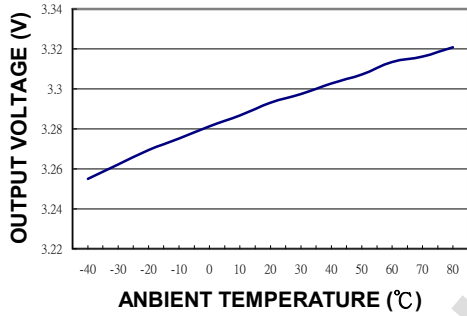

ADJ PIN CURRENT vs. INPUT VOLTAGE

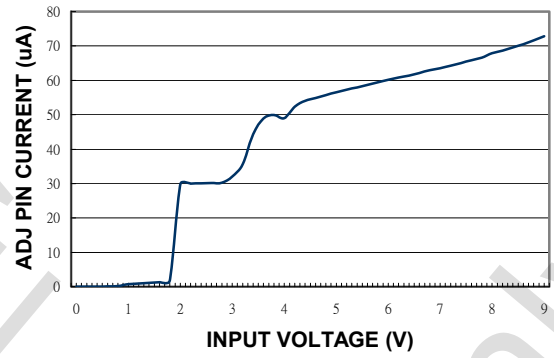

ADJ PIN CURRENT vs. LOAD CURRENT

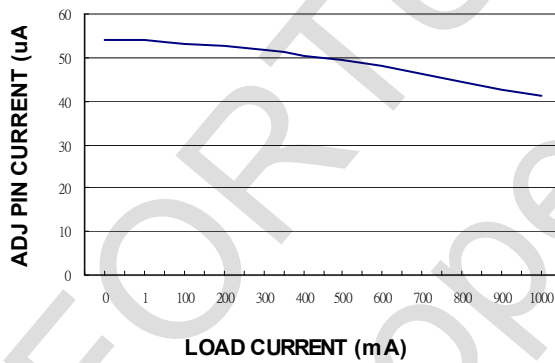

ADJ PIN CURRENT vs. AMBIENT TEMPERATURE

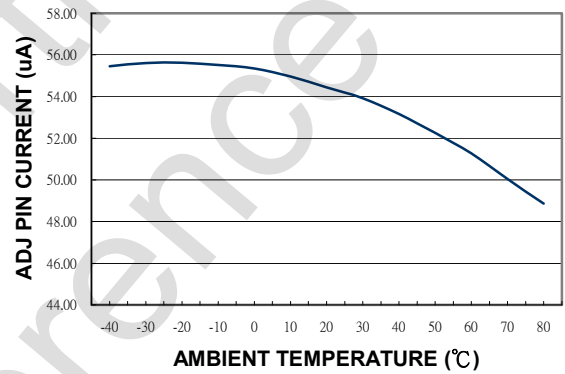

Vref vs. AMBIENT TEMPERATURE

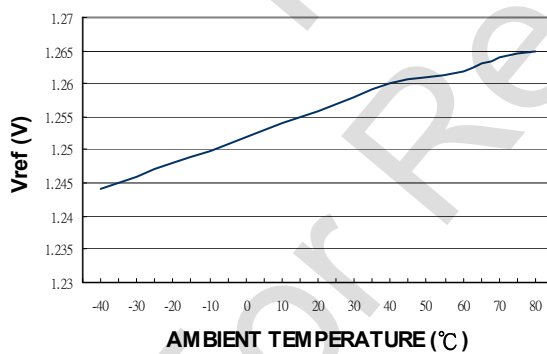

Output Noise DC to 1MHz

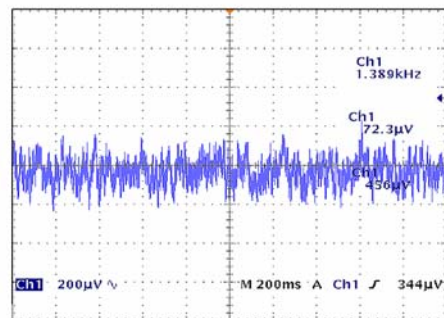

I_{Load}=0

Line Transient (IOUT=250mA)

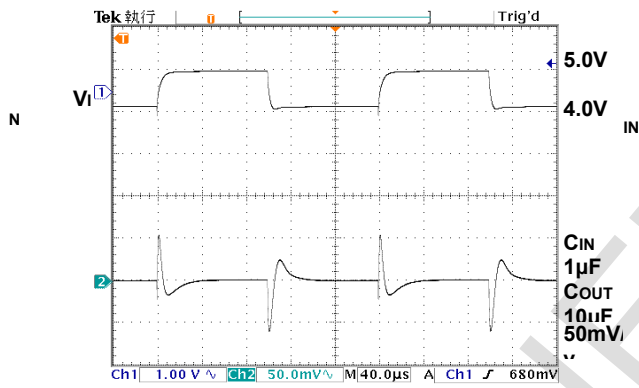

Line Transient (IOUT=50mA)

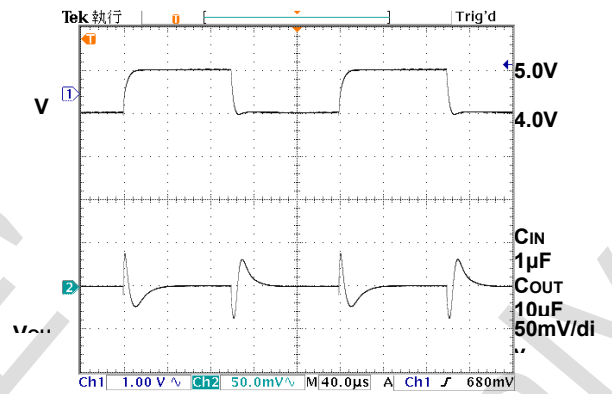

Line Transient (IOUT=100mA)

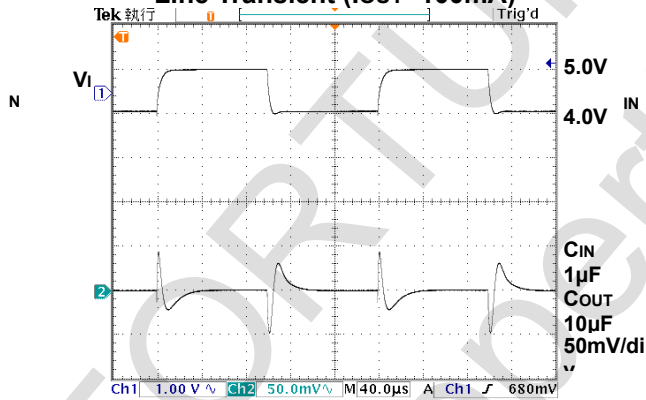

Line Transient (IOUT=0mA)

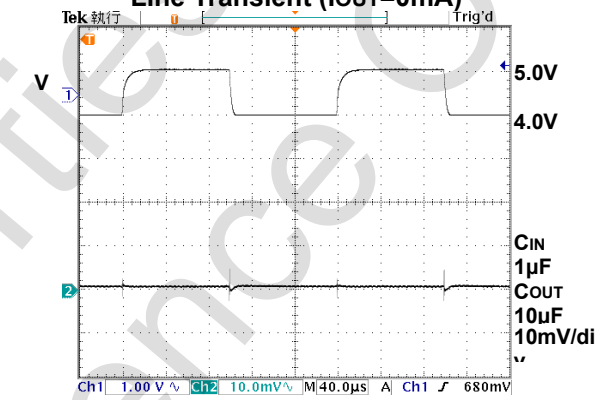

Load Transient

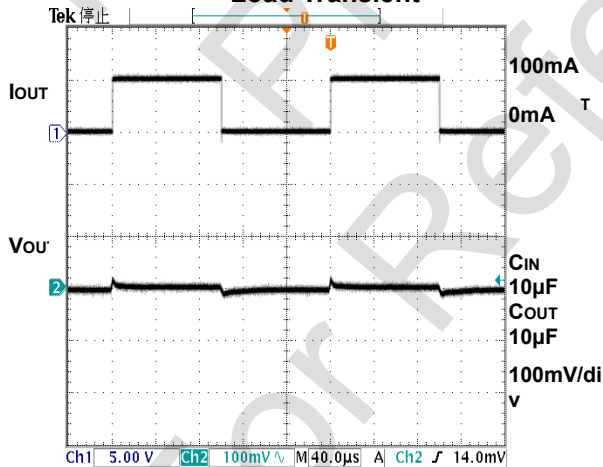

Load Transient

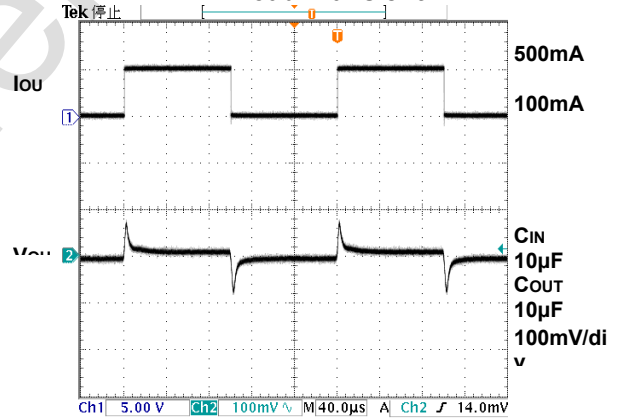

Load Transient

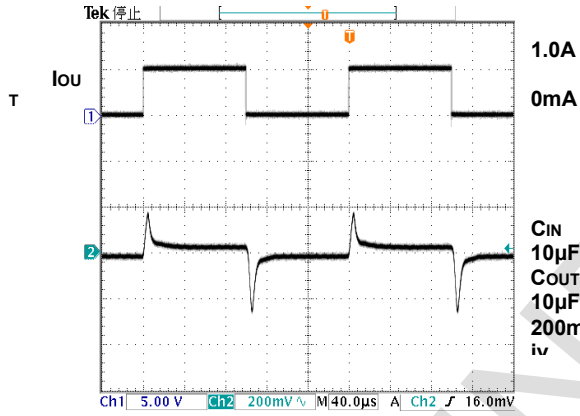

Load Transient

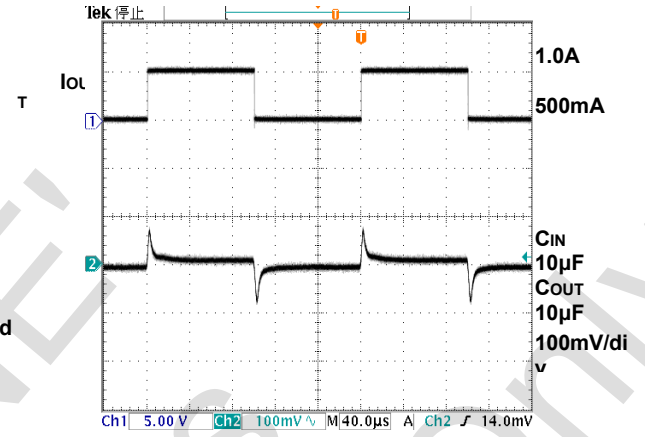

12. Detail Description

The FS8860 is a low-dropout linear regulator. The device provides preset 1.8V and 3.3V output voltages for output current up to 1.0A. Adjustable output voltage and other mask options for special output voltages are also available. As illustrated in function block diagram, it consists of a 1.25V bandgap reference, an error amplifier, a P-channel pass transistor and an internal feedback voltage divider (fixed voltage types).

The 1.25V bandgap reference is connected to the error amplifier, which compares this reference with the feedback voltage and amplifies the voltage difference. If the feedback voltage is lower than the reference voltage, the pass-transistor gate is pulled lower, which allows more current to pass to the output pin and increases the output voltage. If the feedback voltage is too high, the pass-transistor gate is pulled up to decrease the output voltage.

The output voltage is feed back through an internal resistive divider (or external resistive divider for adjustable output voltage type) connected to OUT pin. Additional blocks include an output current limiter, thermal sensor, and shutdown logic.

Internal P-channel Pass Transistor

The FS8860 features a P-channel MOSFET pass transistor. Unlike similar designs using PNP pass transistors, P-channel MOSFETs require no base drive, which reduces ground pin current. PNP-based regulators also waste considerable current in dropout when the pass transistor saturates, and use high base-drive currents under large loads. The FS8860 does not suffer from these problems and consumes only 65 μ A (Typ.) of ground pin current under heavy loads as well as in dropout conditions.

Output Voltage Selection

For fixed voltage type of FS8860, the output voltage is preset at an internally trimmed voltage. The first two digits of part number suffix identify the output voltage (see [Ordering Information](#)). For example, the FS8860-33CJ has a preset 3.3V output voltage.

For adjustable voltage type of FS8860, the output voltage is set by comparing the feedback voltage at adjust terminal to the internal bandgap reference voltage. The reference voltage VREF is 1.25V. The output voltage is given by the equation:

$$V_{OUT} = V_{REF} \cdot (1 + R_2/R_1) + I_{ADJ} \cdot R_2$$

(see [Typical Application Schematic](#))

Current Limit

The FS8860 also includes a fold back current limiter. It monitors and controls the pass transistor's gate voltage, estimates the output current, and limits the output current within 1.3A.

Thermal Overload Protection

Thermal overload protection limits total power dissipation in the FS8860. When the junction temperature exceeds $T_J = +155^\circ\text{C}$, a thermal sensor turns off the pass transistor, allowing the IC to cool down. The thermal sensor turns the pass transistor on again after the junction temperature cools down by 20°C , resulting in a pulsed output during continuous thermal overload conditions.

Thermal overload protection is designed to protect the FS8860 in the event of fault conditions. For continuous operation, the maximum operating junction temperature rating of $T_J = +125^{\circ}\text{C}$ should not be exceeded.

Operating Region and Power Dissipation

Maximum power dissipation of the FS8860 depends on the thermal resistance of the case and circuit board, the temperature difference between the die junction and ambient air, and the rate of airflow. The power dissipation across the devices is $P = I_{OUT} \times (V_{IN} - V_{OUT})$. The resulting maximum power dissipation is:

$$P_{MAX} = \frac{(T_J - T_A)}{\theta_{JC} + \theta_{CA}} = \frac{(T_J - T_A)}{\theta_{JA}}$$

Where $(T_J - T_A)$ is the temperature difference between the FS8860 die junction and the surrounding air, θ_{JC} is the thermal resistance of the package chosen, and θ_{CA} is the thermal resistance through the printed circuit board, copper traces and other materials to the surrounding air. For better heat-sinking, the copper area should be equally shared between the IN, OUT, and GND pins.

If the FS8860 uses a SOT-223 package and this package is mounted on a double sided printed circuit board with two square inches of copper allocated for "heat spreading", the resulting θ_{JA} is 80°C/W .

Based on the maximum operating junction temperature 125°C with an ambient of 25°C , the maximum power dissipation will be:

$$P_{MAX} = \frac{(T_J - T_A)}{\theta_{JC} + \theta_{CA}} = \frac{(125 - 25)}{80} = 1.25\text{W}$$

Thermal characteristics were measured using a double-sided board with $1" \times 2"$ square inches of copper area connected to the GND pin for "heat spreading".

Input-Output Voltage

A regulator's minimum input-output voltage differential, or dropout voltage, determines the lowest usable supply voltage. In battery-powered systems, this will determine the useful end-of-life battery voltage. The FS8860 uses a P-channel MOSFET pass transistor, its dropout voltage is a function of drain-to-source on-resistance ($R_{DS(ON)}$) multiplied by the output current.

$$V_{DROPOUT} = V_{IN} - V_{OUT} = R_{DS(ON)} \times I_{OUT}$$

13. Package Outline

SOT-223

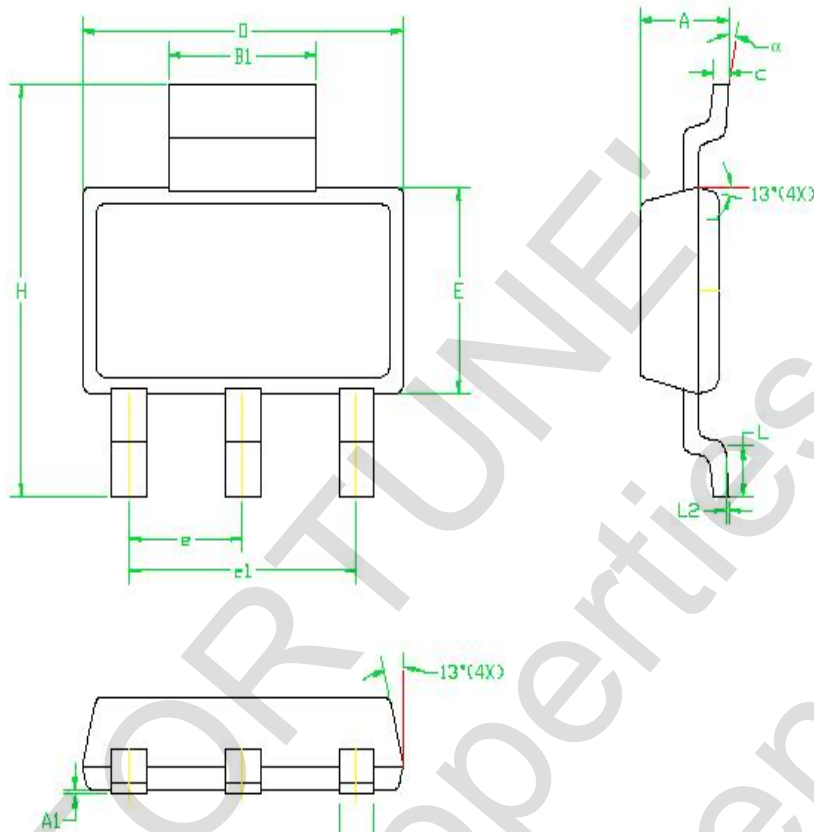

SYMBOLS	MILLIMETERS		INCHES	
	MIN	MAX	MIN	MAX
A	1.55	1.80	0.061	0.071
A1	0.02	0.12	0.0008	0.0047
B	0.60	0.80	0.024	0.031
B1	2.90	3.10	0.114	0.122
e	0.24	0.32	0.009	0.013
D	6.30	6.70	0.248	0.264
E	3.30	3.70	0.130	0.146
e	2.30 BSC		0.090 BSC	
e1	4.60 BSC		0.181 BSC	
H	6.70	7.30	0.264	0.287
L	0.90 MIN		0.036 MIN	
L2	0.06 BSC		0.0024 BSC	
α	0° 10°		0° 10°	

14. Revision History

Version	Date	Page	Description
1.3	2003/04/08	1	Features : The original statement of "Logic Control Shutdown Function" is a misdescription.
1.3	2003/04/08	1	Ordering Information : The meaning of "C" in Temperature Range is revised from "-40°C to +70°C" to "Commercial Standard".
1.3	2003/04/08	4	Absolute Maximum Ratings : Add Operating Junction Temperature Range -40°C to +125°C; Operating Ambient Temperature Range is revised from "-40°C to +80°C" to "-40°C to +85°C"
1.3	2003/04/08	5	Electrical Characteristics : Revise "Fixed Voltage Type $V_{IN} \geq V_{OUT}+0.7V$ " to " $V_{IN} \geq V_{OUT}+1.0V$ ".
1.4	2003/05/06	5	Electrical Characteristics : Cancel example $V_{OUT}=3.3V$, and show the whole range of V_{OUT} (Fixed Voltage Type $V_{OUT}=1.3V\sim 4.5V$)
1.4	2003/05/06	6	Typical Operating Characteristics : Cancel example $V_{OUT}=3.3V$, and show the whole range of V_{OUT} (Fixed Voltage Type $V_{OUT}=1.3V\sim 4.5V$)
1.5	2003/09/02	1	General Description : Correct wording
1.5	2003/09/02	1	Features : Correct wording
1.5	2003/09/02	1	Ordering Information : Correct wording
1.5	2003/09/02	2	Package Marking Information : Remove SOT-23.
1.5	2003/09/02	3	PIN Description : Correct wording
1.5	2003/09/02	3	Typical Application Schematic : Add V_{ref} and I_{adj} indication, rewrite the equation
1.5	2003/09/02	4	Absolute Maximum Rating : Change the value of current limit from 1.6A to 1.3A.
1.5	2003/09/02	5	Electrical Characteristics : Move the value of Max. Load Current in "typical field" to "Min. field" Change the value of current limit from 1.6A to 1.3A Add Thermal Resistance θ_{JA} for SOT-23
1.5	2003/09/02	6	Typical Operating Characteristics : Add $I_{load} = 0$ test condition
1.5	2003/09/02	9	Detail Description : Correct wording
1.6	2004/03/16	1	General Description : Cancel the support for whole range from 1.3V to 4.5V with 100mV increment. Support 3 standard output voltages 1.8V/2.5V/3.3V and adjustable output type. Reserve 1.5V/2.85V/3.0V/3.6V output voltages by special order only. Support SOT-223/TO-252 packages only. Cancel TO-263/TO-220 packages support. Correct wording.
1.6	2004/03/16	1	Features : Support SOT-223/TO-252 packages only. Cancel TO-263/TO-220 packages support.
1.6	2004/03/16	1	Ordering Information : Cancel the support for whole range from 1.3V to 4.5V with 100mV increment. Support 3 standard output voltages 1.8V/2.5V/3.3V and adjustable output type. Reserve 1.5V/2.85V/3.0V/3.6V output voltages by special order only. Support SOT-223/TO-252 packages only. Cancel TO-263/TO-220 packages support. Reserve CG/CH/CJ/CP/CR 5 package types only. Change GND to GND/ADJ in pin configuration tables.
1.6	2004/03/16	2	Pin Description : Reserve CG/CH/CJ/CP/CR 5 package types only. Correct wording. Change GND to GND/ADJ in pin description tables.
1.6	2004/03/16	3	Change Typical Application Schematic to Typical Application Circuit.

Version	Date	Page	Description
1.6	2004/03/16	3	Change Function Block Diagrams to Functional Block Diagrams.
1.6	2004/03/16	3	Absolute Maximum Ratings : Cancel TO-263/ TO-220 packages. Remove Operating ambient temperature range.
1.6	2004/03/16	4	Electrical Characteristics : Add Symbol column.
1.6	2004/03/16	5	Typical Operating Characteristics : Change all labels "TEMPERATURE" to "AMBIENT TEMPERATURE". Current header "Ron vs. LOAD CURRENT"
1.6	2004/03/16	8/9	Detail Description : Correct wording.
1.6	2004/03/16	10	Change Package Information to Package Outline
1.6	2004/03/16	10/11	Package Outline : Cancel TO-263/TO-220 packages. Update SOT-223/TO-252 package diagrams.
1.6	2004/03/16	All	Update page header and footer to standard format. Update page layout and style to standard format.
1.7	2004/05/11	1	Ordering Information: Add Pb/P free package option
1.7	2004/05/11	2	Package Marking Information: Add Pb/P free package marking information
1.7	2004/05/11	3	Absolute Maximum Rating: Change continuous power dissipation to "Internally Limited". Add maximum junction temperature +155°C.
1.7	2004/05/11	4	Electrical Characteristics: Change thermal shutdown temperature from 170°C to 155°C.
1.7	2004/05/11	4	Electrical Characteristics: Change thermal resistance of SOT-223 from 80 to 155 under no heat-sink condition. Change thermal resistance of TO-252 from 70 to 90.
1.7	2004/05/11	9	Operating Region and Power Dissipation: Change the result of power dissipation calculation example for SOT-223. The calculated value is based on new thermal resistance and recommended operating temperature range.
1.8	2006/08/04	1/2/5/6	Change FSC's LOGO. Add input/output capacitor option. Change PSRR test condition F=1kHz. Change PSRR electrical diagram.
1.9	2009/08/05	3	Ordering Information: Update package C、L、I Update package type G stands for Green-Package Update Output Voltage 18 : 1.8V、29 : 2.9V、30 : 3.0V、33 : 3.3V
2.0	2010/10/20	3	Add Output 1.5V, 2.8V
2.1	2011/01/31	3	Add Output 2.5V, 3.6V
2.2	2014/05/22	2	Revised company address