

# Silicon – Diode Array

## **FSA2719M**

8 Diode Array

75V/350mA

# DATASHEET

OEM – Fairchild

Source: Fairchild Databook 1978

**FSA2619M • FSA2619P • FSA2620M • FSA2620P  
FSA2621M • FSA2719M • FSA2719P • FSA2720M  
FSA2720P • FSA2721M**

**PLANAR AIR-ISOLATED MONOLITHIC DIODE ARRAYS**

- C... 2.0 pF (MAX) FSA2719 Series
- $\Delta V_F$ ... 15 mV (MAX) @ 10 mA

**ABSOLUTE MAXIMUM RATINGS** (Notes 1 and 5)

**Temperatures**

Storage Temperature Range (M Suffix) (P Suffix)	-55° C to +200° C
Maximum Junction Operating Temperature	-55° C to +150° C
Lead Temperature	+150° C +260° C

**Power Dissipation** (Note 2)

Maximum Dissipation per Junction at 25° C Ambient	400 mW
Maximum Dissipation per Package at 25° C Ambient	650 mW
Linear Derating factor (from 25° C) Junction	3.2 mW / °C
Package	5.2 mW / °C

**Maximum Voltage and Currents**

WIV	Working Inverse Voltage FSA2619 (Note 5) FSA2719	75 V 50 V
$I_F$	Continuous Forward Current	350 mA
$I_F$ (surge)	Peak Forward Surge Current	
	Pulse Width = 1.0 s	1.0 A
	Pulse Width = 1.0 $\mu$ s	2.0 A

**CONNECTION DIAGRAMS**

**FSA2619 • FSA2719**

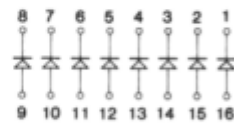

See Package Outlines

6B (Ceramic DIP)	FSA2619M FSA2719M
9B (Plastic DIP)	FSA2619P FSA2719P

**ELECTRICAL CHARACTERISTICS** (25° C Ambient Temperature unless otherwise noted)

SYMBOL	CHARACTERISTIC	MIN	MAX	UNITS	TEST CONDITIONS
BV	Breakdown Voltage (Note 5)	75		V	$I_R = 5.0 \mu A$ $I_R = 100 \mu A$
$I_R$	Reverse Current		5.0 25 50 100 100	$\mu A$ nA $\mu A$ nA $\mu A$	$V_R = 75 V$ $V_R = 20 V$ $V_R = 20 V, T_A = 150^\circ C$ $V_R = 50 V$ $V_R = 50 V, T_A = 150^\circ C$
$V_F$	Forward Voltage (Note 3)		1.0	V	$I_F = 10 mA$
$t_{rr}$	Reverse Recovery Time (Note 6)		5.0 6.0	ns	$I_F = I_r = 10 mA, I_{rr} = 1.0 mA$ $I_F = I_r = 10 mA, I_{rr} = 1.0 mA$
C	Capacitance (Note 6)		4.0 2.0	pF pF	$V_R = 0$ $V_R = 0$
$\Delta V_F$	Forward Voltage Match (Note 6)		15	mV	$I_F = 10 mA$
$t_{fr}$	Forward Recovery Time (Note 6)		20	ns	50 mA Peak square wave, 0.1 $\mu s$ Pulse Width, 5.0 kHz - 100 kHz
$V_{FM}$	Peak Forward Voltage (Note 6)		3.0	V	$I_F = 100 mA, t_r \leq 10 ns$
RE	Rectification Efficiency	45		%	$V_I = 2 V rms, f = 100 MHz$

**NOTES:**

- These ratings are limiting values above which life or satisfactory performance may be impaired.
- These are steady state limits. The factory should be consulted or applications involving pulsed or low duty-cycle operation.
- $V_F$  is measured using an 8 ns pulse.
- See test circuits (Note 6) for measurement of reverse current of an individual diode.
- FSA2619 denotes series FSA2619M/P, FSA2620M/P and FSA2621M.  
FSA2719 denotes series FSA2719M/P, FSA2720M/P and FSA2721M.
- For product family characteristics curves and test circuits, refer to Chapter 4, D15.

\*UNCONNECTED

FAIRCHILD • DIODE ARRAYS

### TO-86 OUTLINE

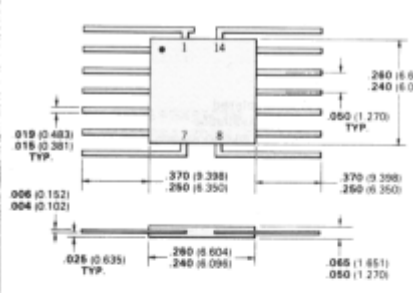

**NOTES:**  
 Alloy 42 Leads, tin plated  
 Gold plated leads available  
 Hermetically sealed ceramic package  
 Dot or tab indicates lead 1  
 Package weight is 0.27 gram

**FSA2620 • FSA2621**  
**FSA2720 • FSA2721**

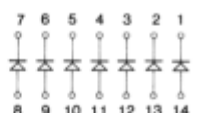

See Package Outlines

TO-116-2 (Ceramic)	FSA2620M
	FSA2720M
TO-116 (Plastic)	FSA2620P
	FSA2720P
TO-86	FSA2621M
	FSA2721M

### 6B OUTLINE

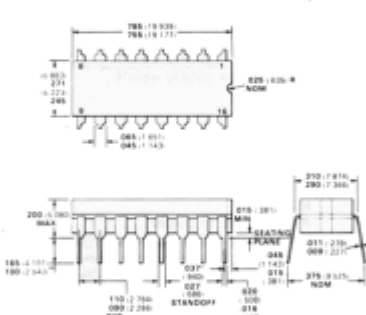

**NOTES:**  
 Alloy 42 pins, tin plated  
 Gold plated pins available  
 Hermetically sealed ceramic package  
 Pins are intended for insertion in hole rows on .300" centers (7.62)  
 They are purposely shipped with "positive" misalignment to facilitate insertion  
 Board-drilling dimensions should equal your practice for .020 inch diameter pin (0.51)  
 Package weight is 2.0 grams  
 \*The .037-.027 dimension does not apply to the corner pins

### 9B OUTLINE

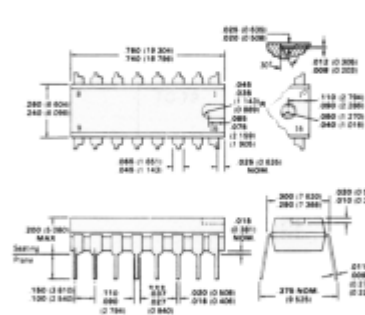

**NOTES:**  
 Alloy 42 pins, tin plated  
 Gold plated pins available  
 Transfer moulded DM-6B plastic package  
 Pins are intended for insertion in hole rows on .300" (7.62) centers  
 Leads purposely have a "positive" misalignment to facilitate insertion  
 Board-drilling dimensions should equal your practice for .020 inch (0.51) diameter pin  
 \*\*\* The .037-.027 (0.94-0.69) dimension does not apply to the corner pins

FAIRCHILD • ZENER DIODES

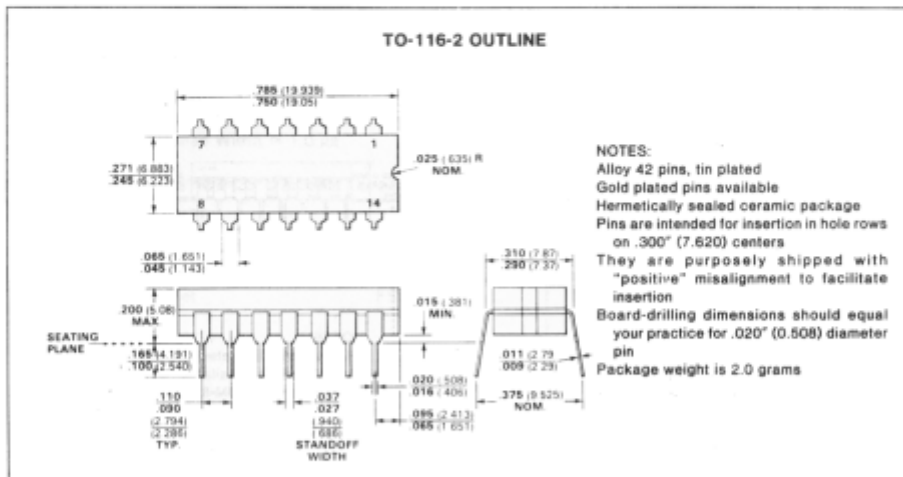
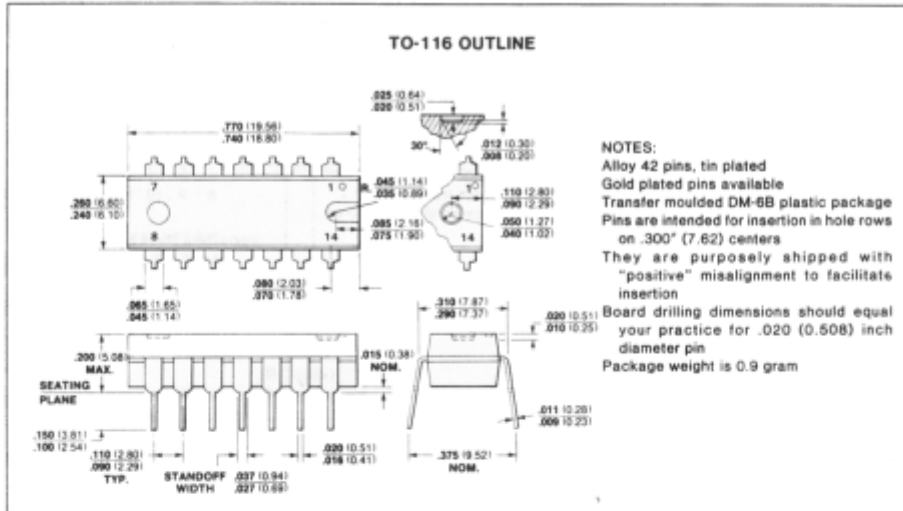

**CURVE SET NUMBER D15**  
**AIR-ISOLATED MONOLITHIC DIODE ARRAY**

**TYPICAL ELECTRICAL CHARACTERISTIC CURVES**  
 AT 25°C AMBIENT TEMPERATURE UNLESS OTHERWISE NOTED

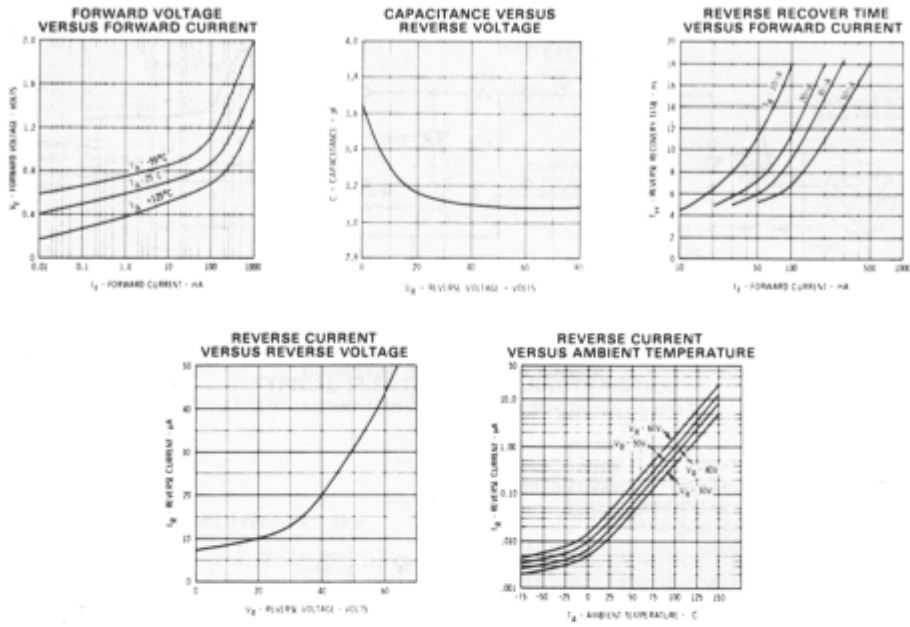

**TEST CIRCUITS**

To measure reverse current of an individual diode, the following test circuits are used:

**COMMON CATHODE DIODES**

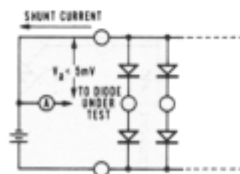

**COMMON ANODE DIODES**

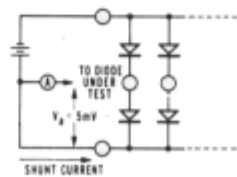

**CURVE SET NUMBER D15**  
**AIR-ISOLATED MONOLITHIC DIODE ARRAY**

**TEST CIRCUITS**

Test requirement for  $V_{FM}$  and  $t_{rr}$  is as shown below; all leads should be as short as possible.

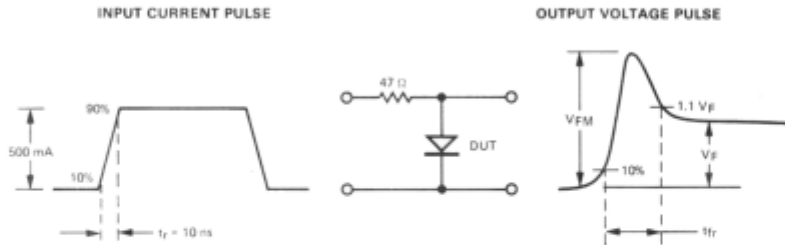

**$t_{rr}$  - REVERSE RECOVERY TIME TEST CIRCUIT**  
 $I_F = I_R = I_{rr} = 0.1 I_F$

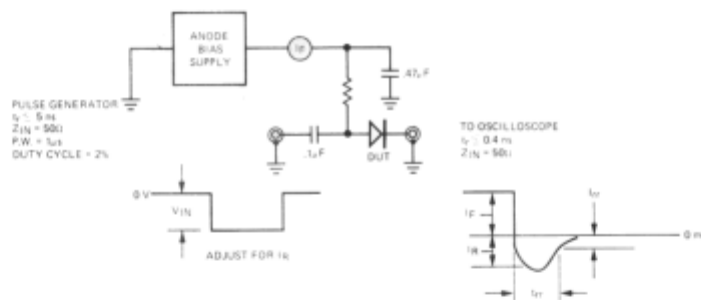

**$\Delta V_F$  BRIDGE MATCHING CIRCUIT**

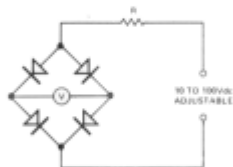

- NOTES:**
- $R$  Varies depending on the current range. For the most often used current ranges,  $R$  is as follows:
- | Current Range (amperes)     | $R$ (ohms) |
|-----------------------------|------------|
| $10^{-5}$ to $10^{-4}$      | $10^6$     |
| $10^{-4}$ to $10^{-3}$      | $10^5$     |
| $10^{-3}$ to $10^{-2}$      | $10^4$     |
| or $10^{-n}$ to $10^{-n+1}$ | $10^{n+1}$ |
- $V$  indicates mismatch of assembly.

**$\Delta I_R$  BRIDGE MATCHING CIRCUIT**

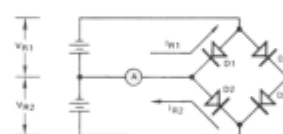

- NOTES:**
- $V_{R2} = V_{R1} \pm 1\%$ .
  - $I_{R2} - I_{R1} = \Delta I_R$  (difference in  $I_R$  between diodes D1 & D2). To measure diodes D3 & D4, reverse cathode-anode terminal connections.
  - $A$  is a center reading pico ammeter.  $\Delta I_R$  indicated directly on  $A$ .