

FSB660 / FSB660A

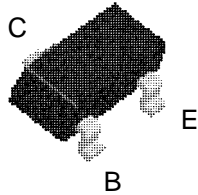

SuperSOT™-3 (SOT-23)

PNP Low Saturation Transistor

These devices are designed with high current gain and low saturation voltage with collector currents up to 2A continuous.

Absolute Maximum Ratings* T_A = 25°C unless otherwise noted

Symbol	Parameter	FSB660/FSB660A	Units
V _{CEO}	Collector-Emitter Voltage	60	V
V _{CB0}	Collector-Base Voltage	60	V
V _{EB0}	Emitter-Base Voltage	5	V
I _C	Collector Current - Continuous	2	A
T _J , T _{stg}	Operating and Storage Junction Temperature Range	-55 to +150	°C

*These ratings are limiting values above which the serviceability of any semiconductor device may be impaired.

NOTES:

- 1) These ratings are based on a maximum junction temperature of 150°C.
- 2) These are steady state limits. The factory should be consulted on applications involving pulsed or low duty cycle operations.

Thermal Characteristics T_A = 25°C unless otherwise noted

Symbol	Characteristic	Max	Units
		FSB660/FSB660A	
P _D	Total Device Dissipation	500	mW
R _{θJA}	Thermal Resistance, Junction to Ambient	250	°C/W

PNP Low Saturation Transistor

(continued)

Electrical Characteristics $T_A = 25^\circ\text{C}$ unless otherwise noted

Symbol	Parameter	Test Conditions	Min	Max	Units
OFF CHARACTERISTICS					
BV_{CEO}	Collector-Emitter Breakdown Voltage	$I_C = 10 \text{ mA}$	60		V
BV_{CBO}	Collector-Base Breakdown Voltage	$I_C = 100 \mu\text{A}$	60		V
BV_{EBO}	Emitter-Base Breakdown Voltage	$I_E = 100 \mu\text{A}$	5		V
I_{CBO}	Collector Cutoff Current	$V_{CB} = 30 \text{ V}$ $V_{CB} = 30 \text{ V}, T_A = 100^\circ\text{C}$		100 10	nA uA
I_{EBO}	Emitter Cutoff Current	$V_{EB} = 4\text{V}$		100	nA
ON CHARACTERISTICS*					
h_{FE}	DC Current Gain	$I_C = 100 \text{ mA}, V_{CE} = 2 \text{ V}$ $I_C = 500 \text{ mA}, V_{CE} = 2 \text{ V}$ FSB660 FSB660A $I_C = 1 \text{ A}, V_{CE} = 2 \text{ V}$ $I_C = 2 \text{ A}, V_{CE} = 2 \text{ V}$	70 100 250 80 40	300 550	-
$V_{CE(sat)}$	Collector-Emitter Saturation Voltage	$I_C = 1 \text{ A}, I_B = 100 \text{ mA}$ $I_C = 2 \text{ A}, I_B = 200 \text{ mA}$ FSB660 FSB660A		300 350 300	mV
$V_{BE(sat)}$	Base-Emitter Saturation Voltage	$I_C = 1 \text{ A}, I_B = 100 \text{ mA}$		1.25	V
$V_{BE(on)}$	Base-Emitter On Voltage	$I_C = 1 \text{ A}, V_{CE} = 2 \text{ V}$		1	V
SMALL SIGNAL CHARACTERISTICS					
C_{obo}	Output Capacitance	$V_{CB} = 10 \text{ V}, I_E = 0, f = 1 \text{ MHz}$		30	pF
f_T	Transition Frequency	$I_C = 100 \text{ mA}, V_{CE} = 5 \text{ V}, f = 100 \text{ MHz}$	75		-

*Pulse Test: Pulse Width $\leq 300 \mu\text{s}$, Duty Cycle $\leq 2.0\%$

Typical Characteristics

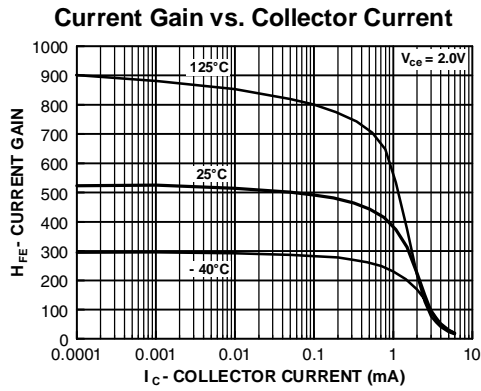
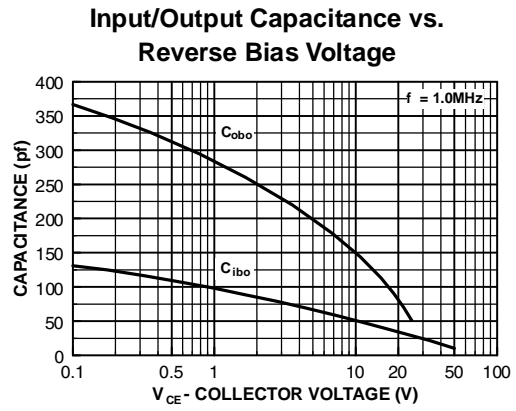
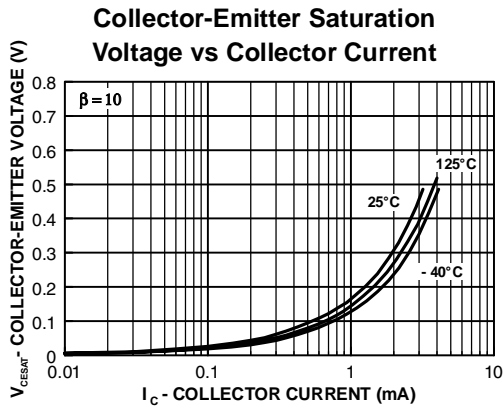
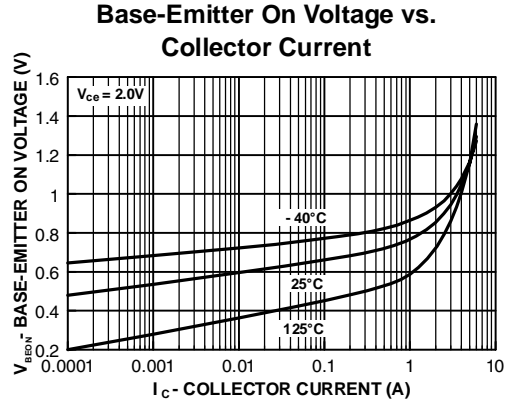
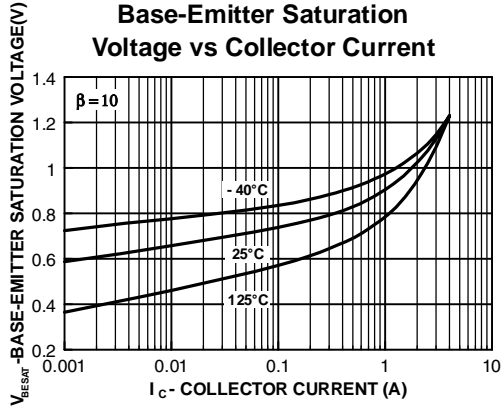

SuperSOT™-3 Tape and Reel Data and Package Dimensions



SSOT-3 Packaging Configuration: Figure 1.0

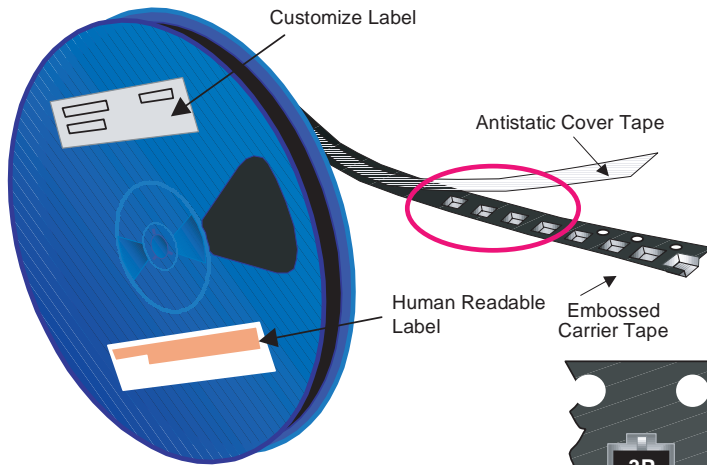

Packaging Description:

SSOT-3 parts are shipped in tape. The carrier tape is made from a dissipative (carbon filled) polycarbonate resin. The cover tape is a multilayer film (Heat Activated Adhesive in nature) primarily composed of polyester film, adhesive layer, sealant, and anti-static sprayed agent. These reeled parts in standard option are shipped with 3,000 units per 7" or 177cm diameter reel. The reels are dark blue in color and is made of polystyrene plastic (anti-static coated). Other option comes in 10,000 units per 13" or 330cm diameter reel. This and some other options are described in the Packaging Information table.

These full reels are individually labeled and placed inside a standard intermediate made of recyclable corrugated brown paper with a Fairchild logo printing. One pizza box contains eight reels maximum. And these intermediate boxes are placed inside a labeled shipping box which comes in different sizes depending on the number of parts shipped.

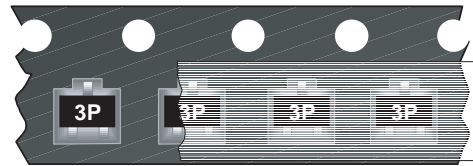

SSOT-3 Std Unit Orientation

SSOT-3 Std Packaging Information		
Packaging Option	Standard (no flow code)	D87Z
Packaging type	TNR	TNR
Qty per Reel/Tube/Bag	3,000	10,000
Reel Size	7" Dia	13"
Box Dimension (mm)	187x107x183	343x343x64
Max qty per Box	24,000	30,000
Weight per unit (gm)	0.0097	0.0097
Weight per Reel (kg)	0.1230	0.4150
Note/Comments		

343mm x 342mm x 64mm Intermediate box for D87Z Option

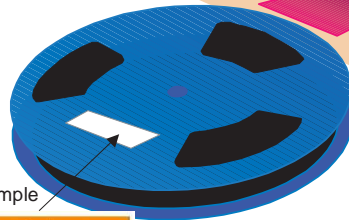

Human Readable Label sample



Human Readable Label

187mm x 107mm x 183mm Intermediate Box for Standard Option

SSOT-3 Tape Leader and Trailer Configuration: Figure 2.0

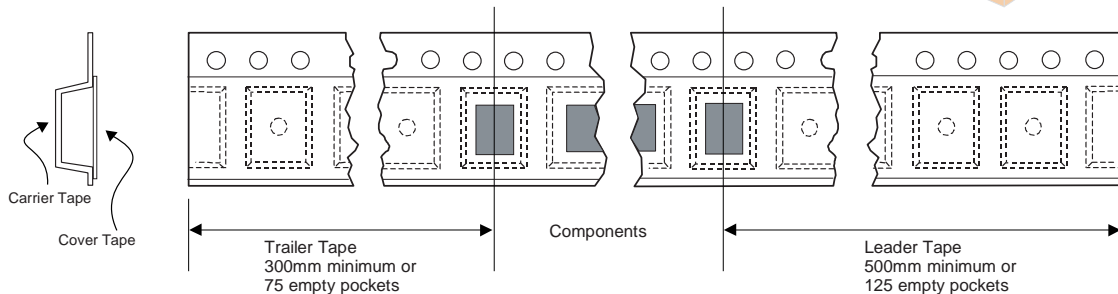

SuperSOT™-3 Tape and Reel Data and Package Dimensions, continued

SSOT-3 Embossed Carrier Tape Configuration: Figure 3.0

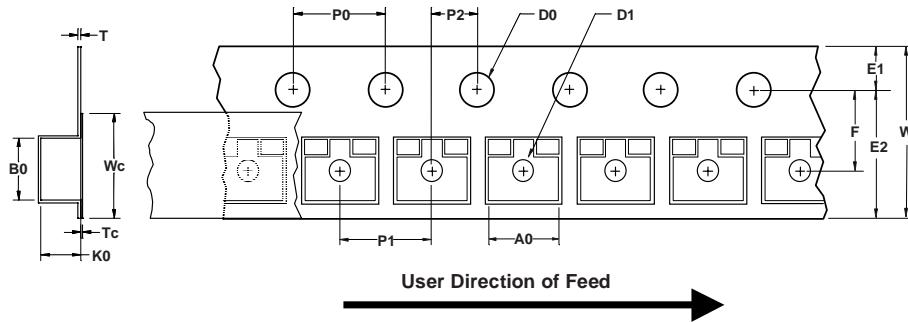

Dimensions are in millimeter														
Pkg type	A0	B0	W	D0	D1	E1	E2	F	P1	P0	K0	T	Wc	Tc
SSOT-3 (8mm)	3.15 +/-0.10	2.77 +/-0.10	8.0 +/-0.3	1.55 +/-0.05	1.125 +/-0.125	1.75 +/-0.10	6.25 min	3.50 +/-0.05	4.0 +/-0.1	4.0 +/-0.1	1.30 +/-0.10	0.228 +/-0.013	5.2 +/-0.3	0.06 +/-0.02

Notes: A0, B0, and K0 dimensions are determined with respect to the EIA/Jedec RS-481 rotational and lateral movement requirements (see sketches A, B, and C).

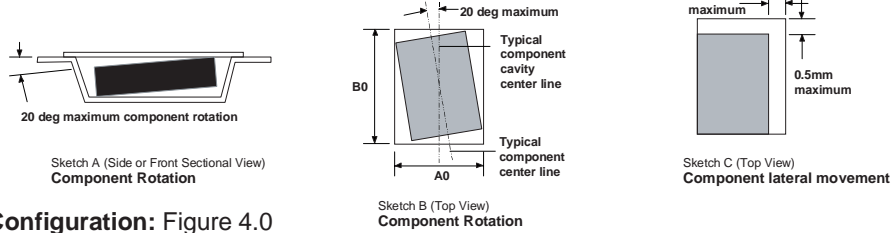

SSOT-3 Reel Configuration: Figure 4.0

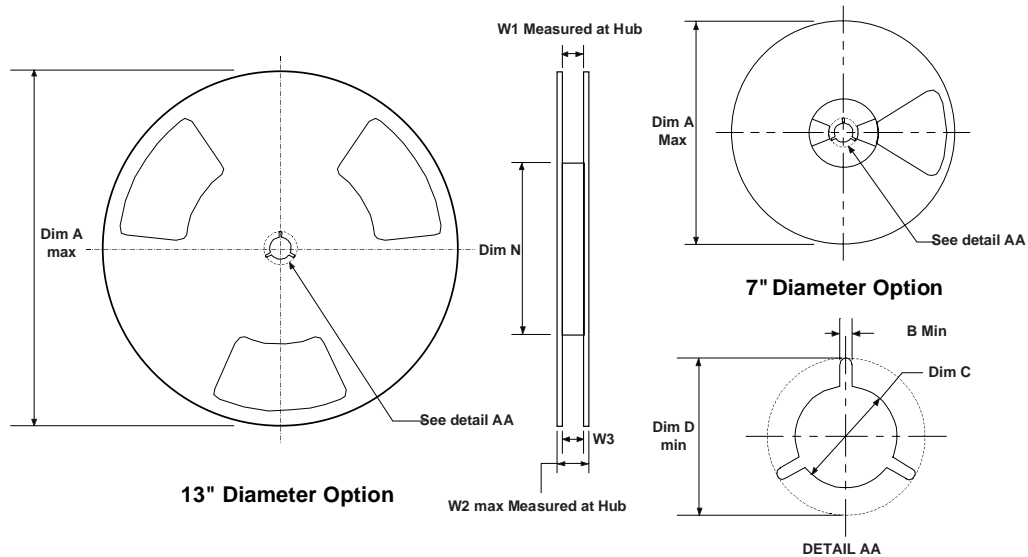

Dimensions are in inches and millimeters									
Tape Size	Reel Option	Dim A	Dim B	Dim C	Dim D	Dim N	Dim W1	Dim W2	Dim W3 (LSL-USL)
8mm	7" Dia	7.00 177.8	0.059 1.5	512 +0.020/-0.008 13 +0.5/-0.2	0.795 20.2	2.165 55	0.331 +0.059/-0.000 8.4 +1.5/0	0.567 14.4	0.311 - 0.429 7.9 - 10.9
8mm	13" Dia	13.00 330	0.059 1.5	512 +0.020/-0.008 13 +0.5/-0.2	0.795 20.2	4.00 100	0.331 +0.059/-0.000 8.4 +1.5/0	0.567 14.4	0.311 - 0.429 7.9 - 10.9

SuperSOT™-3 Tape and Reel Data and Package Dimensions, continued

SuperSOT™-3 (FS PKG Code 32)

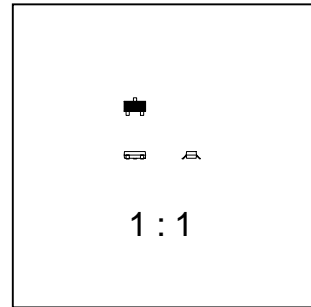
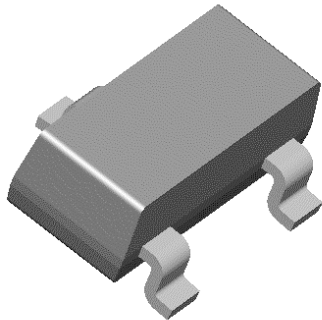

Scale 1:1 on letter size paper

Dimensions shown below are in:
inches [millimeters]

Part Weight per unit (gram): 0.0097

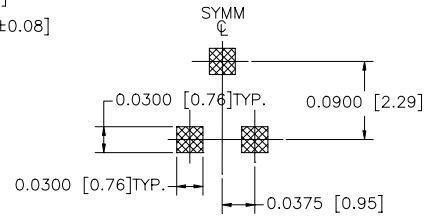
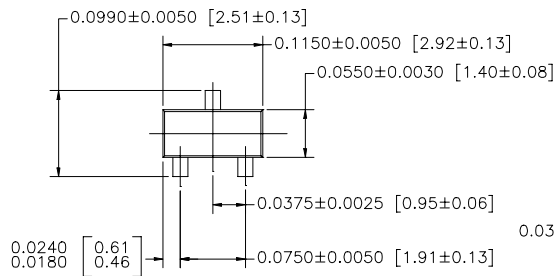

LAND PATTERN RECOMMENDATION

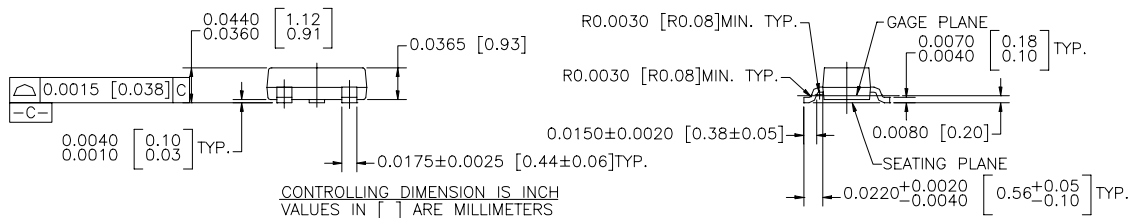

NOTES : UNLESS OTHERWISE SPECIFIED

SUPER SOT , 3 LEADS

- STANDARD LEAD FINISH TO BE 150 MICRINCHES / 3.81 MICROMETERS
MINIMUM TIN/LEAD (SOLDER) ON COPPER.
- NO JEDEC REGISTRATION AS OF DEC. 1995.

TRADEMARKS

The following are registered and unregistered trademarks Fairchild Semiconductor owns or is authorized to use and is not intended to be an exhaustive list of all such trademarks.

ACEx™	HiSeC™	SuperSOT™-8
Bottomless™	ISOPANAR™	SyncFET™
CoolFET™	MICROWIRE™	TinyLogic™
CROSSVOLT™	POP™	UHC™
E ² CMOS™	PowerTrench®	VCX™
FACT™	QFET™	
FACT Quiet Series™	QS™	
FAST®	Quiet Series™	
FASTr™	SuperSOT™-3	
GTO™	SuperSOT™-6	

DISCLAIMER

FAIRCHILD SEMICONDUCTOR RESERVES THE RIGHT TO MAKE CHANGES WITHOUT FURTHER NOTICE TO ANY PRODUCTS HEREIN TO IMPROVE RELIABILITY, FUNCTION OR DESIGN. FAIRCHILD DOES NOT ASSUME ANY LIABILITY ARISING OUT OF THE APPLICATION OR USE OF ANY PRODUCT OR CIRCUIT DESCRIBED HEREIN; NEITHER DOES IT CONVEY ANY LICENSE UNDER ITS PATENT RIGHTS, NOR THE RIGHTS OF OTHERS.

LIFE SUPPORT POLICY

FAIRCHILD'S PRODUCTS ARE NOT AUTHORIZED FOR USE AS CRITICAL COMPONENTS IN LIFE SUPPORT DEVICES OR SYSTEMS WITHOUT THE EXPRESS WRITTEN APPROVAL OF FAIRCHILD SEMICONDUCTOR CORPORATION. As used herein:

1. Life support devices or systems are devices or systems which, (a) are intended for surgical implant into the body, or (b) support or sustain life, or (c) whose failure to perform when properly used in accordance with instructions for use provided in the labeling, can be reasonably expected to result in significant injury to the user.
2. A critical component is any component of a life support device or system whose failure to perform can be reasonably expected to cause the failure of the life support device or system, or to affect its safety or effectiveness.

PRODUCT STATUS DEFINITIONS

Definition of Terms

Datasheet Identification	Product Status	Definition
Advance Information	Formative or In Design	This datasheet contains the design specifications for product development. Specifications may change in any manner without notice.
Preliminary	First Production	This datasheet contains preliminary data, and supplementary data will be published at a later date. Fairchild Semiconductor reserves the right to make changes at any time without notice in order to improve design.
No Identification Needed	Full Production	This datasheet contains final specifications. Fairchild Semiconductor reserves the right to make changes at any time without notice in order to improve design.
Obsolete	Not In Production	This datasheet contains specifications on a product that has been discontinued by Fairchild semiconductor. The datasheet is printed for reference information only.