



FSEZ1216B

Primary-Side-Regulation PWM Integrated Power MOSFET

Features

- Constant-Voltage (CV) and Constant-Current (CC) Control without Secondary-Feedback Circuitry
- Green-Mode Function: PWM Frequency Linearly Decreasing
- Fixed PWM Frequency at 50kHz with Frequency Hopping to Solve EMI Problems
- Cable Compensation in CV mode
- Low Startup Current: 10 μ A
- Low Operating Current: 3.5mA
- Peak-Current-Mode Control in CV Mode
- Cycle-by-Cycle Current Limiting
- V_{DD} Over-Voltage Protection (OVP) with Auto-Restart
- V_{DD} Under-Voltage Lockout (UVLO)
- Fixed Over-Temperature Protection (OTP) with Latch
- DIP-8 Package Available

Applications

- Battery Chargers for Cellular Phones, Cordless Phones, PDA, Digital Cameras, Power Tools
- Best Choice to Replace Linear Transformer and RCC SMPS

Description

This highly integrated PWM controller provides several features to enhance the performance of low-power flyback converters. The proprietary topology enables most simplified circuit design especially for battery charger applications. A low-cost, smaller, and lighter charger results when compared to a conventional design or a linear transformer. The startup current is only 10 μ A, which allows large startup resistance for further power saving.

To minimize the standby-power consumption, the proprietary green-mode function provides off-time modulation to linearly decrease PWM frequency under light-load conditions. This green-mode function assists the power supply in meeting power conservation requirements.

By using FSEZ1216B, a charger can be implemented with few external components and minimized cost. A typical output CV/CC characteristic envelope is shown in Figure 1.

FSEZ1216B series controllers are available in an 8-pin DIP package.

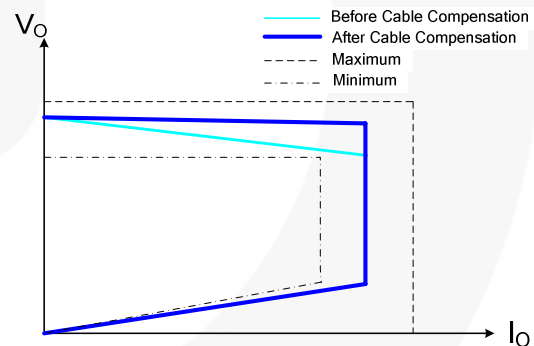

Figure 1. Typical Output V-I Characteristic

Ordering Information

Part Number	Operating Temperature Range	Eco Status	Package	Packing Method
FSEZ1216BNY	-40°C to +105°C	Green	8-Lead, Dual Inline Package (DIP-8)	Tube

 For Fairchild's definition of "green" Eco Status, please visit: http://www.fairchildsemi.com/company/green/rohs_green.html.

Application Diagram

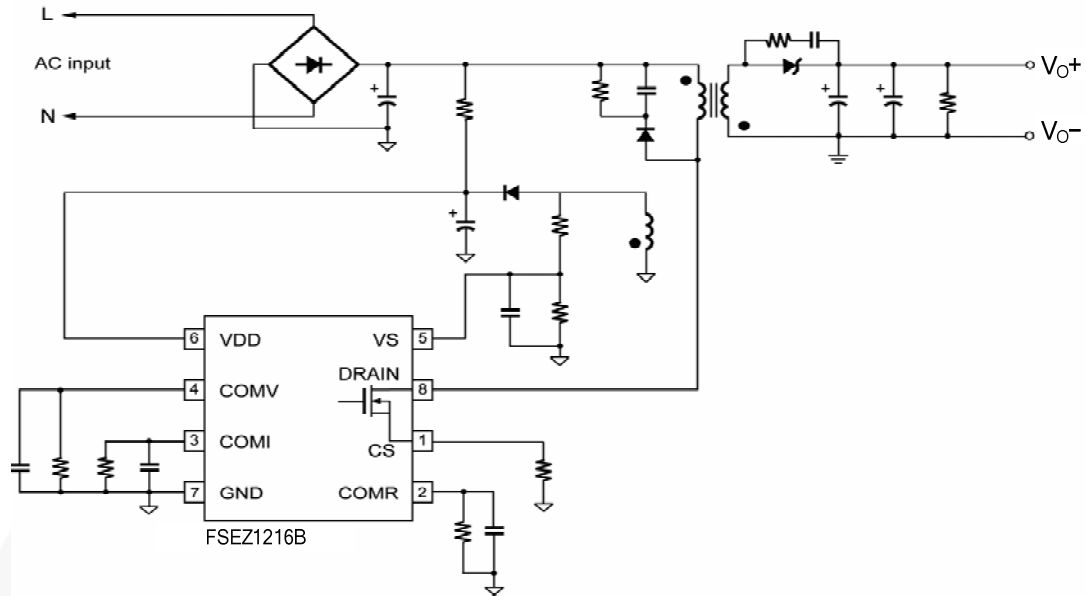

Figure 2. Typical Application

Internal Block Diagram

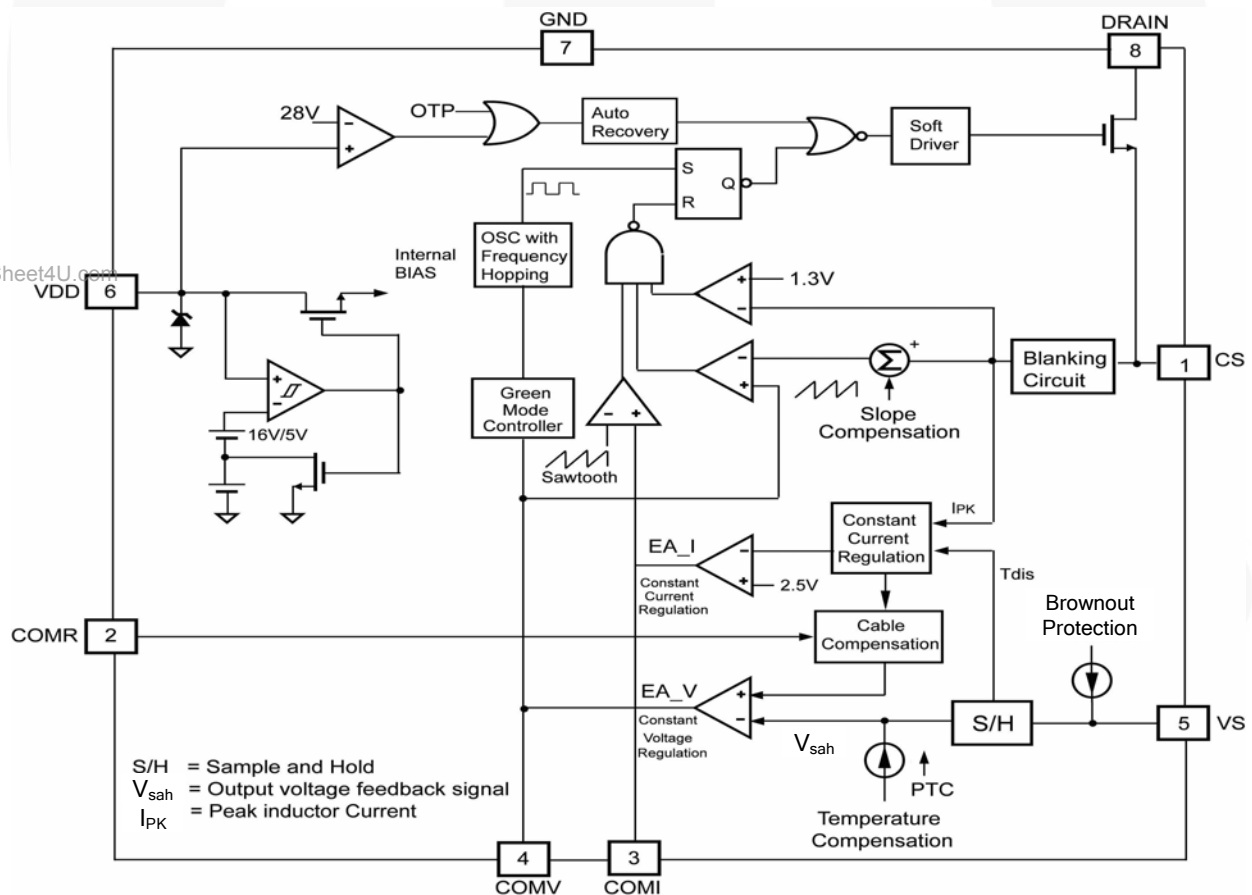
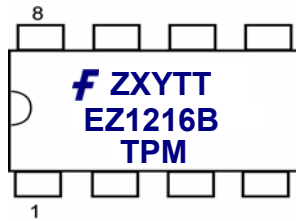

Figure 3. Functional Block Diagram

Marking Information



F- Fairchild Logo
 Z- Plant Code
 X- 1 Digit Year Code
 Y- 1 Digit Week Code
 TT: 2 Digits Die Run Code
 T: Package Type (N=DIP)
 P: Y: Green Package
 M: Manufacture Flow Code

Figure 4. Top Mark

Pin Configuration

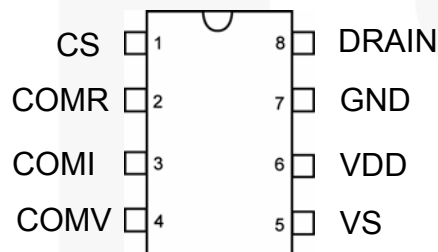

Figure 5. Pin Configuration

Pin Definitions

Pin #	Name	Description
1	CS	Analog Input, Current Sense. Connected to a current-sense resistor for peak-current-mode control in CV mode. The current-sense signal is also provided for output-current regulation in CC mode.
2	COMR	Analog Output, Cable Compensation. Connect a resistor between COMR and GND for cable loss compensation in CV mode.
3	COMI	Analog Output, Current Compensation. Output of the current error amplifier. Connect a capacitor between COMI pin and GND for frequency compensation.
4	COMV	Analog Output, Voltage Compensation. Output of the voltage error amplifier. Connect a capacitor between COMV pin and GND for frequency compensation.
5	VS	Analog Input, Voltage Sense. Output-voltage-sense input for output-voltage regulation.
6	VDD	Supply, Power Supply.
7	GND	Voltage Reference, Ground.
8	DRAIN	Driver Output, Power MOSFET Drain. This pin is the high-voltage power MOSFET drain

Absolute Maximum Ratings

Stresses exceeding the absolute maximum ratings may damage the device. The device may not function or be operable above the recommended operating conditions and stressing the parts to these levels is not recommended. In addition, extended exposure to stresses above the recommended operating conditions may affect device reliability. The absolute maximum ratings are stress ratings only.

Symbol	Parameter	Min.	Max.	Unit
V _{VDD}	DC Supply Voltage ^(1,2)		30	V
V _{VS}	VS Pin Input Voltage	-0.3	7.0	V
V _{CS}	CS Pin Input Voltage	-0.3	7.0	V
V _{COMV}	Voltage-Error Amplifier Output Voltage	-0.3	7.0	V
V _{COMI}	Voltage-Error Amplifier Output Voltage	-0.3	7.0	V
V _{DS}	Drain-Source Voltage		600	V
I _D	Continuous Drain Current	T _C =25°C	1	A
		T _C =100°C	0.6	A
I _{DM}	Pulsed Drain Current		4	A
E _{AS}	Single-Pulse Avalanche Energy		33	mJ
I _{AR}	Avalanche Current		1	A
P _D	Power Dissipation (T _A < 50°C)		800	mW
R _{θJA}	Thermal Resistance (Junction-to-Air)		113	°C/W
R _{θJC}	Thermal Resistance (Junction-to-Case)		67	°C/W
T _J	Operating Junction Temperature		+150	°C
T _{STG}	Storage Temperature Range	-55	+150	°C
T _L	Lead Temperature (Wave Soldering or IR, 10 Seconds)		+260	°C
ESD	Electrostatic Discharge Capability, Human Body Model, JEDEC: JESD22-A114		3.0	KV
	Electrostatic Discharge Capability, Charged Device Model, JEDEC: JESD22-C101		1000	V

Notes:

- Stresses beyond those listed under absolute maximum ratings may cause permanent damage to the device.
- All voltage values, except differential voltages, are given with respect to GND pin.

Recommended Operating Conditions

The Recommended Operating Conditions table defines the conditions for actual device operation. Recommended operating conditions are specified to ensure optimal performance to the datasheet specifications. Fairchild does not recommend exceeding them or designing to Absolute Maximum Ratings.

Symbol	Parameter	Min.	Typ.	Max.	Unit
T _A	Operating Ambient Temperature	-40		+105	°C

Electrical Characteristics

$V_{DD}=15V$, $T_A=25^{\circ}C$, unless otherwise specified.

Symbol	Parameter	Conditions	Min.	Typ.	Max.	Units	
VDD SECTION							
V_{OP}	Continuously Operating Voltage				25	V	
V_{DD-ON}	Turn-On Threshold Voltage		15	16	17	V	
V_{DD-OFF}	Turn-Off Threshold Voltage		4.5	5.0	5.5	V	
I_{DD-ST}	Startup Current	$0 < V_{DD} < V_{DD-ON} - 0.16V$		10	20	μA	
I_{DD-OP}	Operating Current	$V_{DD}=20V$, $f_s=f_{OSC}$, $V_{VS}=2V$, $V_{CS}=3V$, $C_L=1nF$		3.5	5.0	mA	
$I_{DD-GREEN}$	Green-Mode Operating Supply Current	$V_{DD}=20V$, $V_{VS}=2.7V$ $V_{CS}=0V$, $V_{COMV}=0V$ $f_s=f_{OSC-N-MIN}$, $C_L=1nF$		1	2	mA	
V_{DD-OVP}	V_{DD} Over-Voltage-Protection Level	$V_{VS}=2.3V$, $V_{CS}=3V$	27	28	29	V	
$t_{D-VDDOVP}$	V_{DD} Over-Voltage-Protection Debounce Time	$f_s=f_{OSC}$, $V_{VS}=2.3V$	100	250	400	μs	
OSCILLATOR SECTION							
f_{OSC}	Frequency	Center Frequency	$T_A=25^{\circ}C$, $V_{VS}=2.3V$	48	50	55	KHz
		Frequency-Hopping Range	$V_{CS}=1.5V$, $V_{VS}=2V$	± 1.0	± 1.5	± 2.3	
t_{FHR}	Frequency-Hopping Period	$V_{CS}=1.5V$, $V_{VS}=2V$		2.56		ms	
$f_{OSC-N-MIN}$	Minimum Frequency at No-Load	$V_{VS}=2.7V$, $V_{COMV}=0V$		500		Hz	
$f_{OSC-CM-MIN}$	Minimum Frequency at CCM	$V_{VS}=2.3V$, $V_{CS}=0.5V$		18		KHz	
f_{DV}	Frequency Variation vs. V_{DD} Deviation	$V_{DD}=10V$ to $25V$			5	%	
f_{DT}	Frequency Variation vs. Temperature Deviation	$T_A=-40^{\circ}C$ to $105^{\circ}C$			15	%	
VOLTAGE-SENSE SECTION							
I_{VS-UVP}	Sink Current for Brownout Protection	$R_{VS}=20K\Omega$		125		μA	
I_{IC}	IC Compensation Bias Current			9.5		μA	
$V_{BIAS-COMV}$	Adaptive Bias Voltage Dominated by V_{COMV}	$V_{COMV}=0V$, $R_{VS}=20K\Omega$		1.4		V	

Electrical Characteristics

$V_{DD}=15V$, $T_A=25^{\circ}C$, unless otherwise specified.

Symbol	Parameter	Conditions	Min.	Typ.	Max.	Units
CURRENT-SENSE SECTION						
t_{PD}	Propagation Delay to GATE Output			100	200	ns
t_{MIN-N}	Minimum On-Time at No-Load	$V_{VS}=-0.8V$, $R_{CS}=2K\Omega$ $V_{COMV}=1V$		1100		ns
t_{MINCC}	Minimum On-Time in CC Mode	$V_{VS}=0V$, $V_{COMV}=2V$		400		ns
V_{TH}	Threshold Voltage for Current Limit			1.3		V
VOLTAGE-ERROR-AMPLIFIER SECTION						
V_{VR}	Reference Voltage		2.475	2.500	2.525	V
V_N	Green-Mode Starting Voltage on COMV Pin	$f_S=f_{OSC}-2KHz$ $V_{VS}=2.3V$		2.8		V
V_G	Green-Mode Ending Voltage on COMV Pin	$f_S=1KHz$		0.8		V
I_{V-SINK}	Output Sink Current	$V_{VS}=3V$, $V_{COMV}=2.5V$		90		μA
$I_{V-SOURCE}$	Output Source Current	$V_{VS}=2V$, $V_{COMV}=2.5V$		90		μA
V_{V-HGH}	Output High Voltage	$V_{VS}=2.3V$	4.5			V
CURRENT-ERROR-AMPLIFIER SECTION						
V_{IR}	Reference Voltage		2.475	2.500	2.525	V
I_{I-SINK}	Output Sink Current	$V_{CS}=3V$, $V_{COMI}=2.5V$		55		μA
$I_{I-SOURCE}$	Output Source Current	$V_{CS}=0V$, $V_{COMI}=2.5V$		55		μA
V_{I-HGH}	Output High Voltage	$V_{CS}=0V$	4.5			V
CABLE COMPENSATION SECTION						
V_{COMR}	Variation Test Voltage on COMR pin for Cable Compensation	$R_{COMR}=100k\Omega$		0.85		V

www.DataSheet4U.com

Electrical Characteristics

$V_{DD}=15V$, $T_A=25^{\circ}C$, unless otherwise specified.

Symbol	Parameter	Conditions	Min.	Typ.	Max.	Units
INTERNAL MOSFET SECTION						
DCY_{MAX}	Maximum Duty Cycle			75		%
BV_{DSS}	Drain-Source Breakdown Voltage	$I_D=250\mu A$, $V_{GS}=0V$	600			V
$\Delta BV_{DSS} / \Delta T_J$	Breakdown-Voltage Temperature Coefficient	$I_D=250\mu A$, Referenced to $25^{\circ}C$		0.6		$V/^{\circ}C$
I_S	Maximum Continuous Drain-Source Diode Forward Current				1	A
I_{SM}	Maximum Pulsed Drain-Source Diode Forward Current				4	A
$R_{DS(ON)}$	Static Drain-Source On-Resistance	$I_D=0.5A$, $V_{GS}=10V$		9.3	11.5	Ω
I_{DSS}	Drain-Source Leakage Current	$V_{DS}=600V$, $V_{GS}=0V$ $T_C=25^{\circ}C$			1	μA
		$V_{DS}=480V$, $V_{GS}=0V$ $T_C=100^{\circ}C$			10	μA
t_{D-ON}	Turn-On Delay Time	$V_{DS}=300V$, $I_D=1.1A$ $R_G=25\Omega^{(3,4)}$		7	24	ns
t_r	Rise Time			21	52	ns
t_{D-OFF}	Turn-off Delay Time			13	36	ns
t_f	Fall Time			27	64	ns
C_{ISS}	Input Capacitance	$V_{GS}=0V$, $V_{DS}=25V$ $f_S=1MHz$		130	170	pF
C_{OSS}	Output Capacitance			19	25	pF
OVER-TEMPERATURE-PROTECTION SECTION						
T_{OTP}	Threshold Temperature for OTP ⁽⁵⁾			140		$^{\circ}C$

Notes:

- Pulse Test: Pulse width $\leq 300\mu s$, Duty cycle $\leq 2\%$.
- Essentially independent of operating temperature.
- When the OTP is activated, the power system enters latch mode and output is disabled.

Typical Performance Characteristics

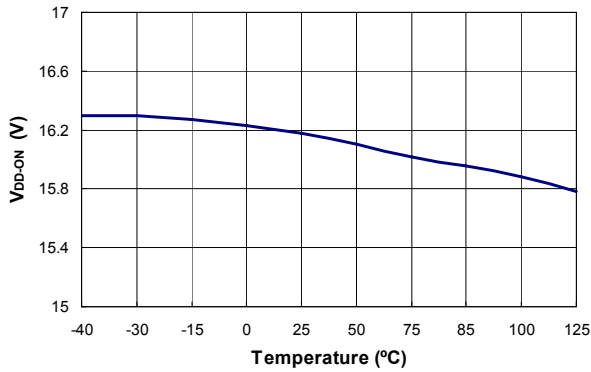

Figure 6. Turn-On Threshold Voltage (V_{DD-ON}) vs. Temperature

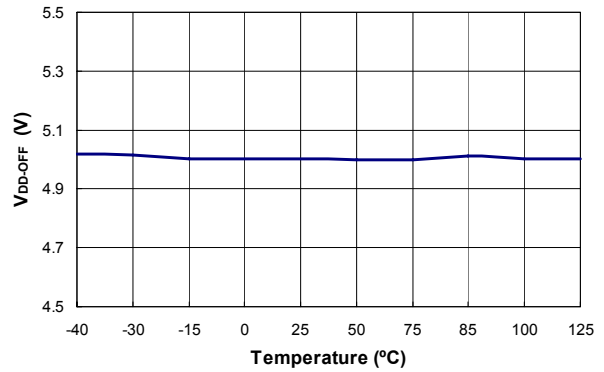

Figure 7. Turn-Off Threshold Voltage (V_{DD-OFF}) vs. Temperature

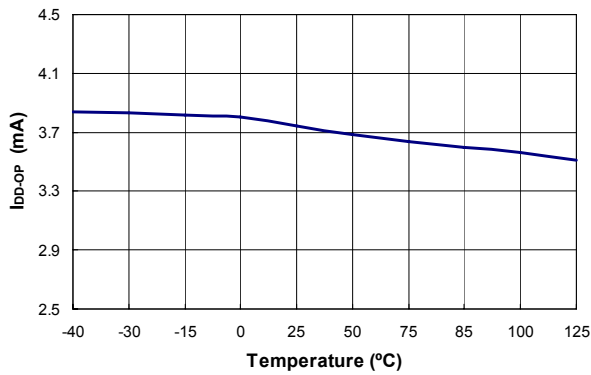

Figure 8. Operating Current (I_{DD-OP}) vs. Temperature

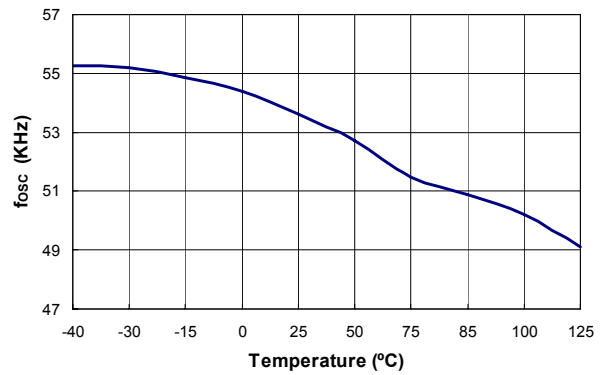

Figure 9. Center Frequency (f_{OSC}) vs. Temperature

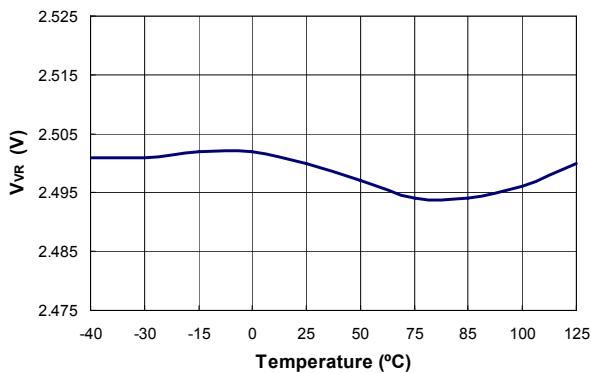

Figure 10. Reference Voltage (V_{VR}) vs. Temperature

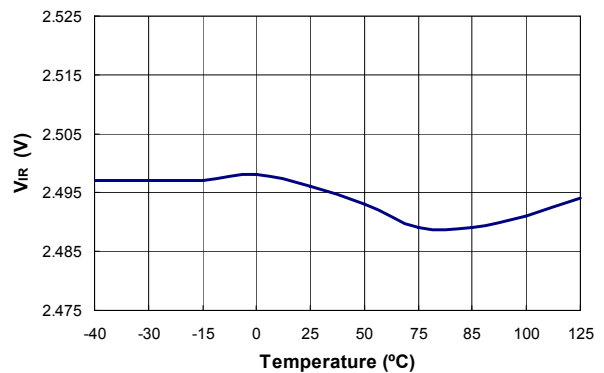

Figure 11. Reference Voltage (V_{IR}) vs. Temperature

www.DataSheet4U.com

Typical Performance Characteristics (Continued)

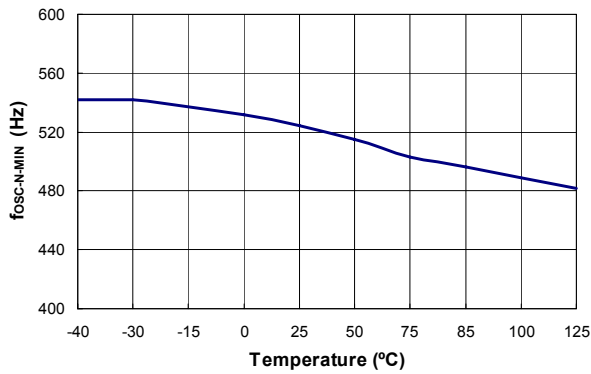

Figure 12. Minimum Frequency at No Load (f_{OSC-N-MIN}) vs. Temperature

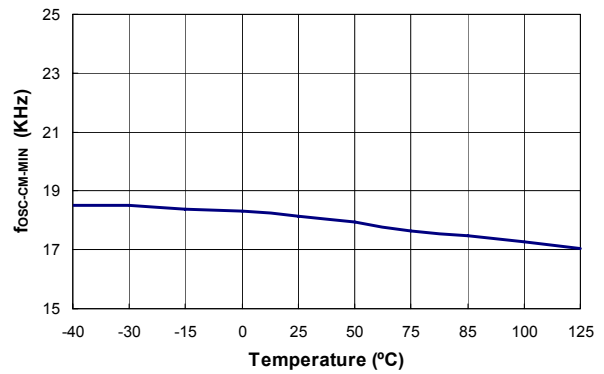

Figure 13. Minimum Frequency at CCM (f_{OSC-CM-MIN}) vs. Temperature

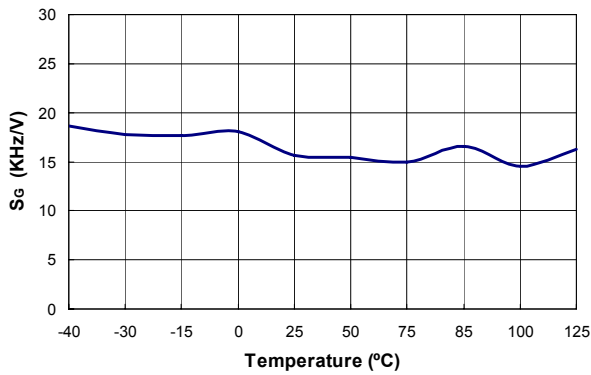

Figure 14. Green-Mode-Frequency Decreasing Rate (S_G) vs. Temperature

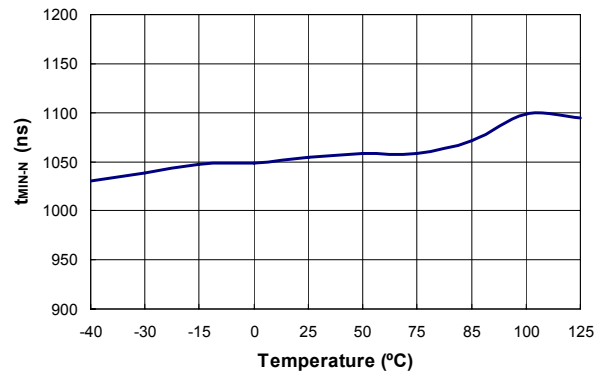

Figure 15. Minimum On-Time at No-Load (t_{MIN-N}) vs. Temperature

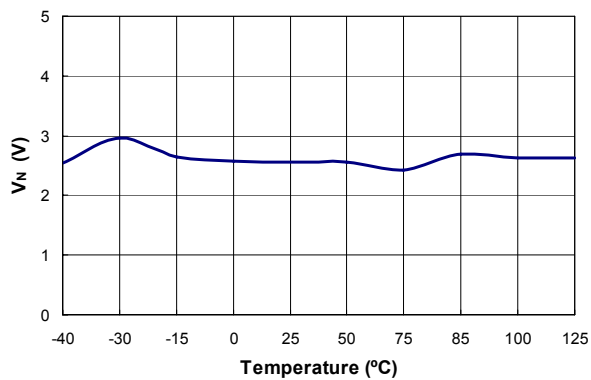

Figure 16. Green Mode Starting Voltage on COMV Pin (V_N) vs. Temperature

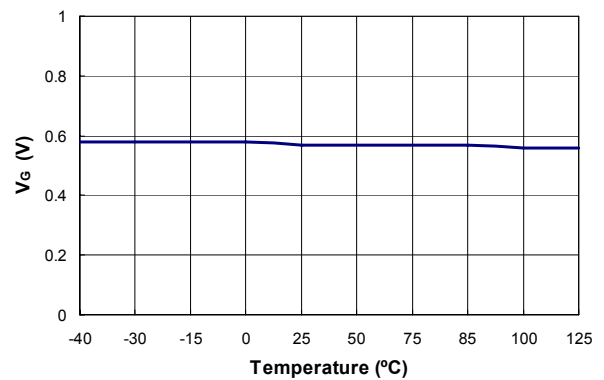

Figure 17. Green Mode Ending Voltage on COMV Pin (V_G) vs. Temperature

Typical Performance Characteristics (Continued)

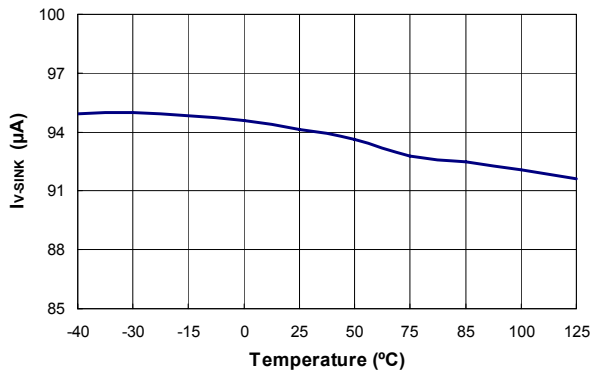

Figure 18. Output Sink Current (I_{v-SINK}) vs. Temperature

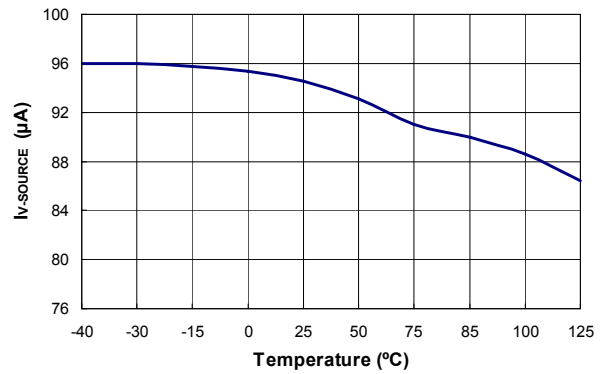

Figure 19. Output Source Current (I_{v-SOURCE}) vs. Temperature

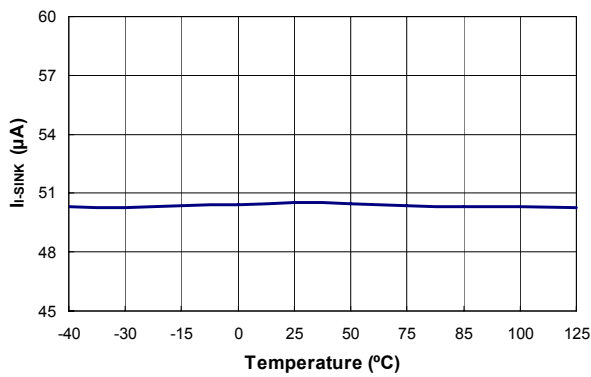

Figure 20. Output Sink Current (I_{i-SINK}) vs. Temperature

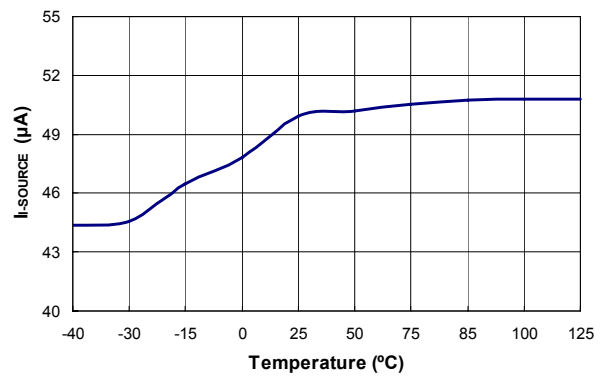

Figure 21. Output Source Current (I_{i-SOURCE}) vs. Temperature

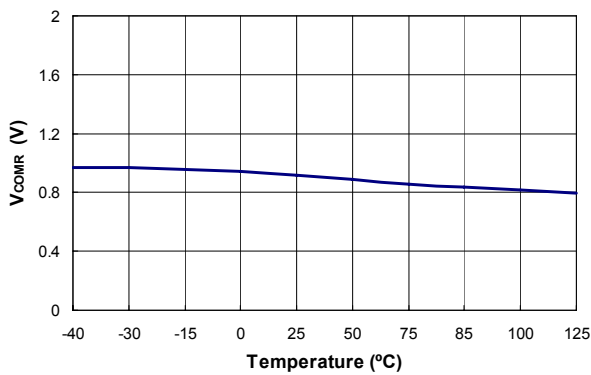

Figure 22. Variation Test Voltage on COMR Pin for Cable Compensation (V_{COMR}) vs. Temperature

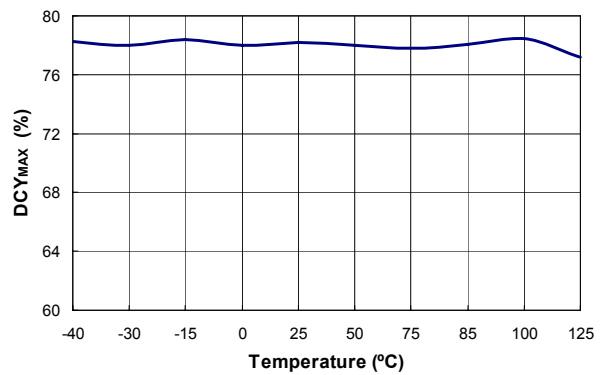

Figure 23. Maximum Duty Cycle (DCY_{MAX}) vs. Temperature

Functional Description

The proprietary topology of FSEZ1216B enables most simplified circuit design especially for battery charger applications. Without secondary feedback circuitry, the CV and CC control can still be achieved accurately. As shown in Figure 24, with the frequency-hopping, PWM operation, EMI problem can be solved by using minimized filter components. FSEZ1216B also provides many protection functions. The VDD pin is equipped with over-voltage protection (OVP) and under-voltage lockout (UVLO). Pulse-by-pulse current limiting and CC control ensure over-current protection (OCP) at heavy loads. The GATE output is clamped at 15V to protect the external MOSFET from over-voltage damage. Also, the internal over-temperature-protection (OTP) function shuts down the controller with latch when over heated.

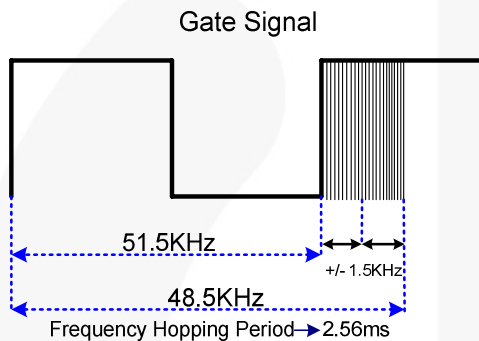

Figure 24. Frequency Hopping

Startup Current

The startup current is only 10 μ A. Low startup current allows a startup resistor with a high resistance and a low wattage to supply the startup power for the controller. A 1.5M Ω , 0.25W, startup resistor and a 10 μ F/25V V_{DD} hold-up capacitor is sufficient for an AC-to-DC power adapter with a wide input range (100V_{AC} to 240V_{AC}).

Operating Current

The operating current has been reduced to 3.5mA. The low operating current results in higher efficiency and reduces the V_{DD} hold-up capacitance requirement. Once FSEZ1216B enters deep-green mode, the operating current is reduced to 1mA, assisting the power supply to easily meet the power conservation requirement.

Green-Mode Operation

Figure 25 shows the characteristics of the PWM frequency vs. the output voltage of the error amplifier (V_{COMV}). The FSEZ1216B uses the positive, proportional, output load parameter (V_{COMV}) as an indication of the output load for modulating the PWM frequency. In heavy-load conditions, the PWM frequency is fixed at 50KHz. Once V_{COMV} is lower than V_N, the PWM frequency starts to linearly decrease from 50KHz to 500Hz, thus providing further power savings and easily meeting international power-conservation requirements.

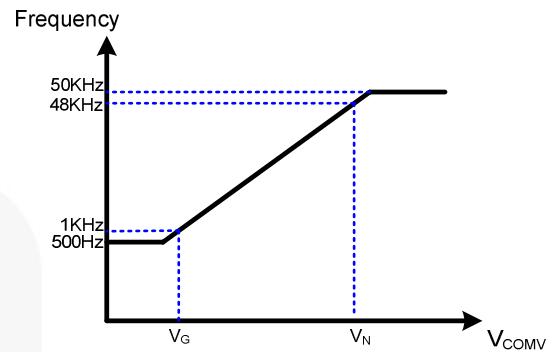

Figure 25. Green-Mode Operation Frequency vs. V_{COMV}

Constant Voltage (CV) and Constant Current (CC) Operation

An innovative technique of the FSEZ1216B can accurately achieve CV/CC characteristic output without secondary-side voltage or current-feedback circuitry. There is a feedback signal from the reflected voltage across the primary auxiliary winding for CV/CC operation. This voltage signal is proportional to secondary winding, so it provides the controller the feedback signal from secondary side and achieves constant-voltage-output property. In constant-current-output operation, this voltage signal is detected and examined by the precise constant-current-regulation controller, then determines the on-time of the MOSFET to control input power and provide constant-current-output property. With feedback voltage V_{CS} across the current-sense resistor, the controller can obtain the input power of the power supply. Therefore, the region of constant-current-output operation can be adjusted by the current sense resistor.

Temperature Compensation

The FSEZ1216B has built-in temperature compensation, in order to get better CV regulation at different ambient temperatures. This internal compensation current is a positive-temperature-coefficient (PTC) current that can compensate the forward-voltage drop of the secondary diode varying with temperature. This variation causes output-voltage rising at high temperature.

Leading-Edge Blanking (LEB)

Each time the power MOSFET is switched on, a turn-on spike occurs at the sense resistor. To avoid premature termination of the switching pulse, a leading-edge blanking time is built in. Conventional RC filtering can therefore be omitted. During this blanking period, the current-limit comparator is disabled and it cannot switch off the gate driver.

Under-Voltage Lockout (UVLO)

The turn-on and turn-off thresholds of the FSEZ1216B are fixed internally at 16V/5V. During startup, the hold-up capacitor must be charged to 16V through the startup resistor, so that the FSEZ1216B is enabled. The hold-up capacitor continues to supply V_{DD} until power can be delivered from the auxiliary winding of the main transformer. V_{DD} must not drop below 5V during this startup process. This UVLO hysteresis window ensures that the hold-up capacitor is adequate to supply V_{DD} during startup.

V_{DD} Over-Voltage Protection (OVP)

V_{DD} OVP is built in to prevent damage due to over-voltage conditions. When the voltage V_{DD} exceeds 28V due to abnormal conditions, PWM pulses are disabled until the V_{DD} voltage drops below the UVLO and then startup again. Over-voltage conditions are usually caused by open feedback loops.

Over-Temperature Protection (OTP)

The FSEZ1216B has a built-in temperature-sensing circuit to shut down PWM output once the junction temperature exceeds 140°C. While PWM output is shut down, the V_{DD} voltage gradually drops to the UVLO

voltage. Some of the FSEZ1216B's internal circuits are shut down, and V_{DD} gradually starts increasing again. When V_{DD} reaches 16V, all the internal circuits including the temperature-sensing circuit starts operating normally. If the junction temperature is still higher than 140°C, the PWM controller is shut down immediately.

Built-In Slope Compensation

The sensed voltage across the current-sense resistor is used for current-mode control and pulse-by-pulse current limiting. Built-in slope compensation improves stability and prevents sub-harmonic oscillations due to peak-current-mode control. The FSEZ1216B has a synchronized, positively-sloped ramp built-in at each switching cycle.

Noise Immunity

Noise from the current sense or the control signal can cause significant pulse-width jitter, particularly in continuous-conduction mode. While slope compensation helps alleviate these problems, further precautions should still be taken. Good placement and layout practices should be followed. Avoid long PCB traces and component leads, locating compensation and filter components near the FSEZ1216B.

Applications Information

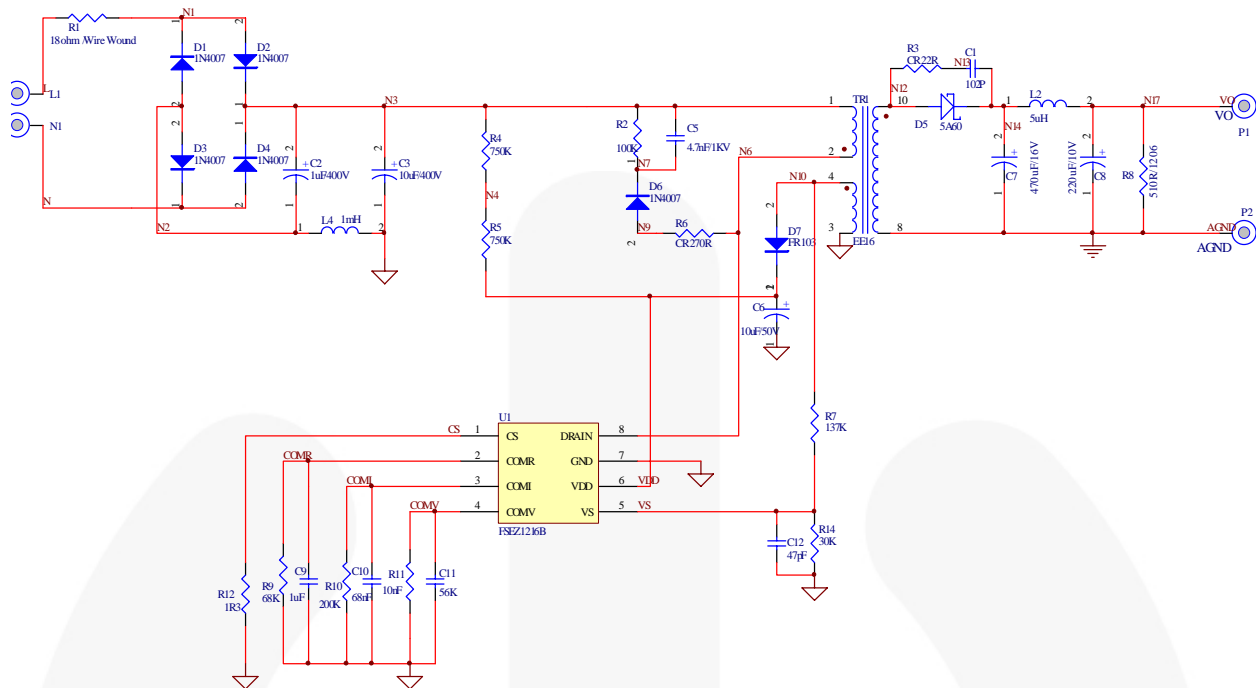
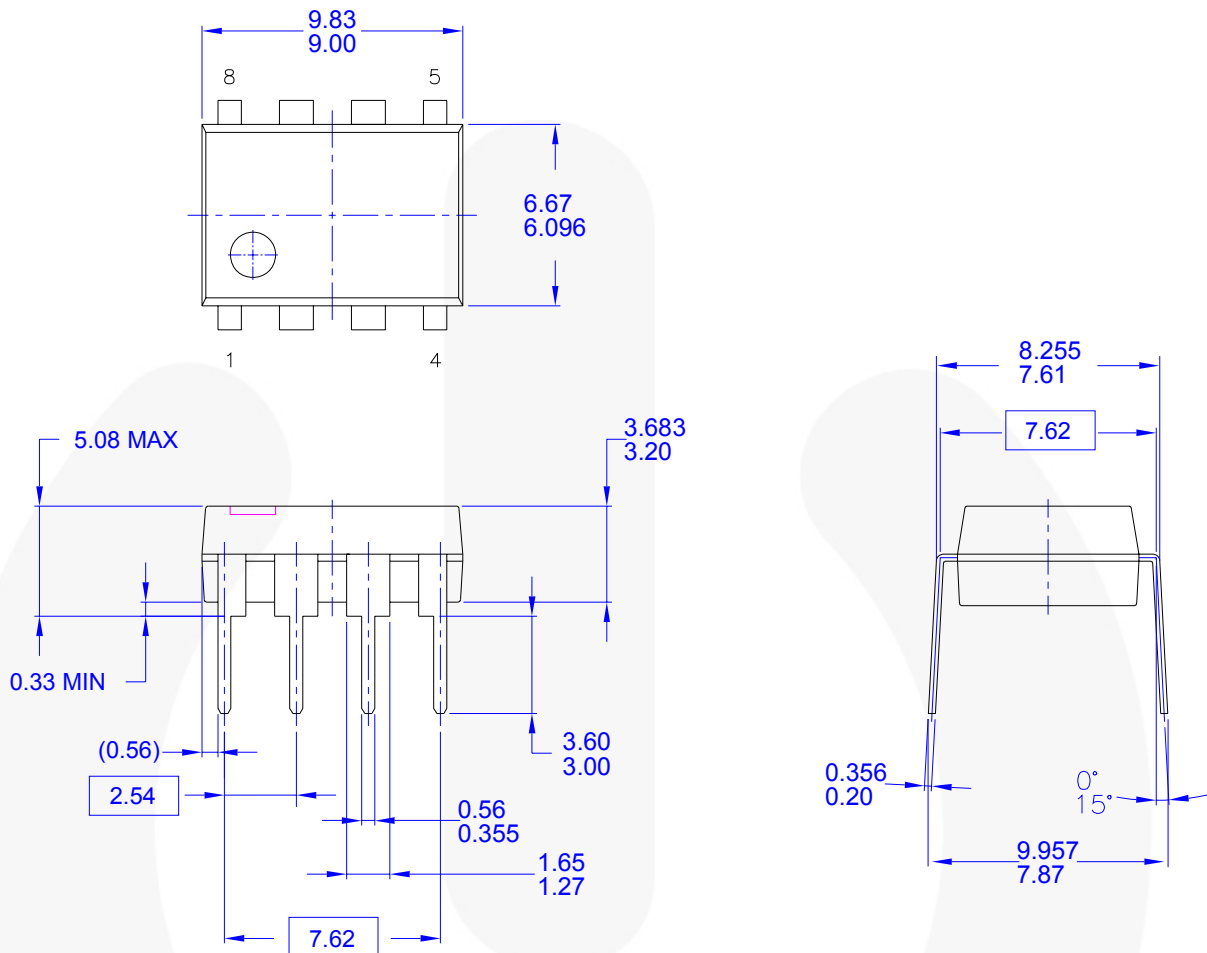

Figure 26. 5W (5V/1A) Application Circuit

BOM

Designator	Part Type	Designator	Part Type
D1, D2, D3, D4, D6	1N4007	R2	R 100KΩ
D5	SB560	R3	R 22Ω
D7	FR103	R4, R5	R 750KΩ
C1	1nF	R6	R 270Ω
C2	EC 1μF/400V	R7	R 137KΩ
C3	EC 10μF/400V	R8	R 510Ω
C5	4.7nF/1KV	R9	R 68KΩ
C6	EC 10μF/50V	R10	R 200KΩ
C7	EC 470μF/16V	R11	R 56KΩ
C8	EC 220μF/10	R12	R 1.3Ω
C9	1μF	R14	R 30Ω
C10	68nF	L4	1mH
C11	10nF	T1	EE16 (1.5mH)
C12	47pF	U1	IC FSEZ1216B
R1	R 18Ω		

Physical Dimensions



www.DataSheet4U.com

NOTES: UNLESS OTHERWISE SPECIFIED

- A) THIS PACKAGE CONFORMS TO JEDEC MS-001 VARIATION BA
- B) ALL DIMENSIONS ARE IN MILLIMETERS.
- C) DIMENSIONS ARE EXCLUSIVE OF BURRS, MOLD FLASH, AND TIE BAR EXTRUSIONS.
- D) DIMENSIONS AND TOLERANCES PER ASME Y14.5M-1994
- E) DRAWING FILENAME AND REVISION: MKT-N08FREV2.

Figure 27. 8-Lead, Dual Inline Package (DIP-8)

Package drawings are provided as a service to customers considering Fairchild components. Drawings may change in any manner without notice. Please note the revision and/or date on the drawing and contact a Fairchild Semiconductor representative to verify or obtain the most recent revision. Package specifications do not expand the terms of Fairchild's worldwide terms and conditions, specifically the warranty therein, which covers Fairchild products.

Always visit Fairchild Semiconductor's online packaging area for the most recent package drawings:
<http://www.fairchildsemi.com/packaging/>



TRADEMARKS

The following includes registered and unregistered trademarks and service marks, owned by Fairchild Semiconductor and/or its global subsidiaries, and is not intended to be an exhaustive list of all such trademarks.

Build it Now™	FRFET®	Programmable Active Droop™	
CorePLUS™	Global Power Resource™ SM	QFET®	
CorePOWER™	Green FPST™	QS™	
CROSSVOLT™	Green FPS™ e-Series™	Quiet Series™	
CTL™	GTO™	RapidConfigure™	
Current Transfer Logic™	IntelliMAX™	™	
EcoSPARK®	ISOPLANAR™	Saving our world, 1mW/W/kW at a time™	
EfficientMax™	MegaBuck™	SmartMax™	
EZSWITCH™ *	MICROCOUPLER™	SMART START™	
™	MicroFET™	SPM®	
™	MillerDrive™	STEALTH™	
Fairchild®	MotionMax™	SuperFET™	
Fairchild Semiconductor®	Motion-SPM™	SuperSOT™.3	
FACT Quiet Series™	OPTOLOGIC®	SuperSOT™.6	
FACT®	OPTOPLANAR®	SuperSOT™.8	
FAST®		SupreMOS™	
FastvCore™	PDP SPM™	SyncFET™	
FlashWriter® *	Power-SPM™	™	
FPS™	PowerTrench®	The Power Franchise®	
F-PFS™	PowerXS™		

* EZSWITCH™ and FlashWriter® are trademarks of System General Corporation, used under license by Fairchild Semiconductor.

DISCLAIMER

FAIRCHILD SEMICONDUCTOR RESERVES THE RIGHT TO MAKE CHANGES WITHOUT FURTHER NOTICE TO ANY PRODUCTS HEREIN TO IMPROVE RELIABILITY, FUNCTION, OR DESIGN. FAIRCHILD DOES NOT ASSUME ANY LIABILITY ARISING OUT OF THE APPLICATION OR USE OF ANY PRODUCT OR CIRCUIT DESCRIBED HEREIN; NEITHER DOES IT CONVEY ANY LICENSE UNDER ITS PATENT RIGHTS, NOR THE RIGHTS OF OTHERS. THESE SPECIFICATIONS DO NOT EXPAND THE TERMS OF FAIRCHILD'S WORLDWIDE TERMS AND CONDITIONS, SPECIFICALLY THE WARRANTY THEREIN, WHICH COVERS THESE PRODUCTS.

LIFE SUPPORT POLICY

FAIRCHILD'S PRODUCTS ARE NOT AUTHORIZED FOR USE AS CRITICAL COMPONENTS IN LIFE SUPPORT DEVICES OR SYSTEMS WITHOUT THE EXPRESS WRITTEN APPROVAL OF FAIRCHILD SEMICONDUCTOR CORPORATION.

As used herein:

1. Life support devices or systems are devices or systems which, (a) are intended for surgical implant into the body or (b) support or sustain life, and (c) whose failure to perform when properly used in accordance with instructions for use provided in the labeling, can be reasonably expected to result in a significant injury of the user.
2. A critical component in any component of a life support, device, or system whose failure to perform can be reasonably expected to cause the failure of the life support device or system, or to affect its safety or effectiveness.

ANTI-COUNTERFEITING POLICY

Fairchild Semiconductor Corporation's Anti-Counterfeiting Policy. Fairchild's Anti-Counterfeiting Policy is also stated on our external website, www.fairchildsemi.com, under Sales Support.

Counterfeiting of semiconductor parts is a growing problem in the industry. All manufacturers of semiconductor products are experiencing counterfeiting of their parts. Customers who inadvertently purchase counterfeit parts experience many problems such as loss of brand reputation, substandard performance, failed applications, and increased cost of production and manufacturing delays. Fairchild is taking strong measures to protect ourselves and our customers from the proliferation of counterfeit parts. Fairchild strongly encourages customers to purchase Fairchild parts either directly from Fairchild or from Authorized Fairchild Distributors who are listed by country on our web page cited above. Products customers buy either from Fairchild directly or from Authorized Fairchild Distributors are genuine parts, have full traceability, meet Fairchild's quality standards for handling and storage and provide access to Fairchild's full range of up-to-date technical and product information. Fairchild and our Authorized Distributors will stand behind all warranties and will appropriately address any warranty issues that may arise. Fairchild will not provide any warranty coverage or other assistance for parts bought from Unauthorized Sources. Fairchild is committed to combat this global problem and encourage our customers to do their part in stopping this practice by buying direct or from authorized distributors.

PRODUCT STATUS DEFINITIONS

Definition of Terms

Datasheet Identification	Product Status	Definition
Advance Information	Formative / In Design	Datasheet contains the design specifications for product development. Specifications may change in any manner without notice.
Preliminary	First Production	Datasheet contains preliminary data; supplementary data will be published at a later date. Fairchild Semiconductor reserves the right to make changes at any time without notice to improve design.
No Identification Needed	Full Production	Datasheet contains final specifications. Fairchild Semiconductor reserves the right to make changes at any time without notice to improve the design.
Obsolete	Not In Production	Datasheet contains specifications on a product that is discontinued by Fairchild Semiconductor. The datasheet is for reference information only.

Rev. I37