

2012 Size

800/850 MHz
Chip Multilayer Coupler

FSLC-S090M-A1

www.DataSheet4U.com

All the technical data and information contained herein are subject to change without notice.



LC-FSLC-S090M-A1-0406A
www.DataSheet4U.com

Equivalent Circuits

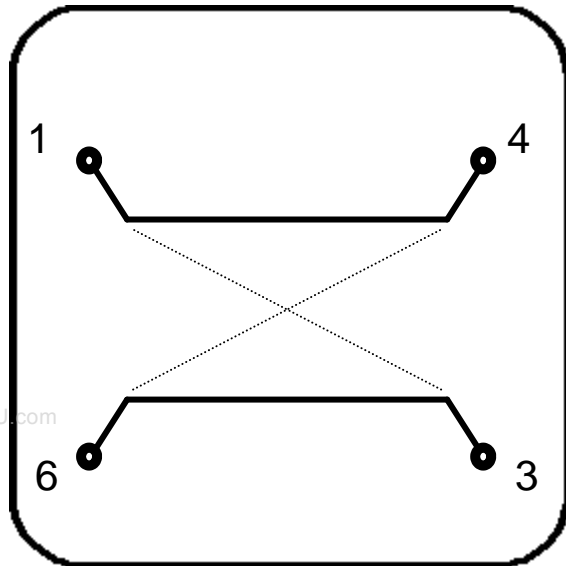

Shape & Size

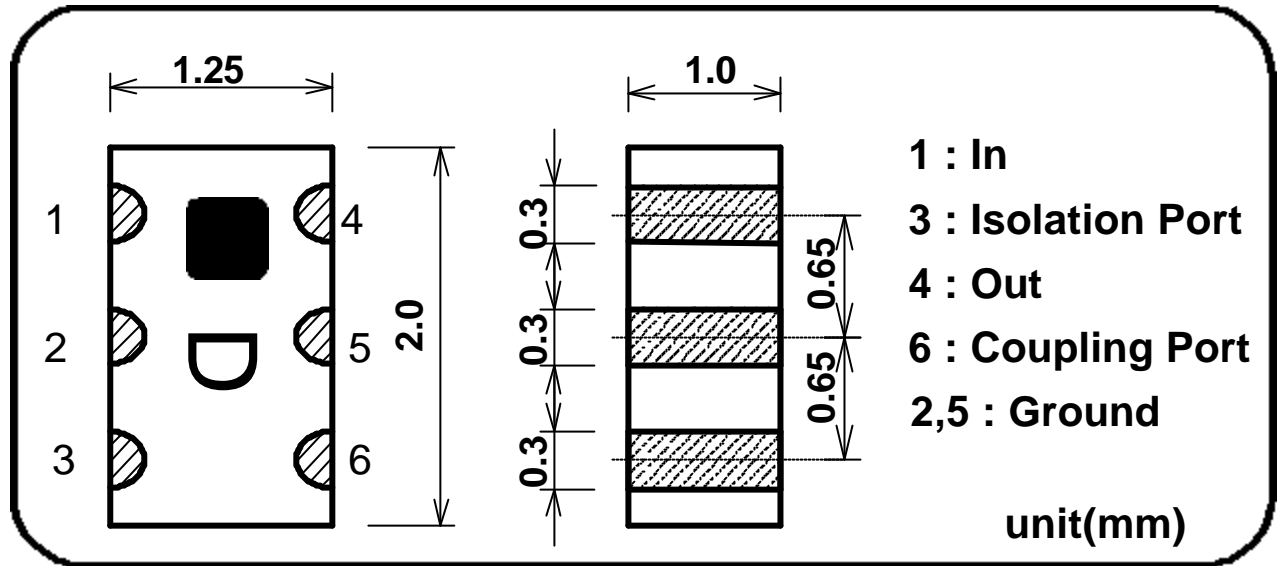

Specifications

Part Name: FSLC-S090M-A1

Frequency Range	Coupling	Insertion Loss	Isolation	Return Loss	Handling Power	Temperature Range
800-850MHz	20.0 +/- 1.5dB	0.3dB Max. (0.15dB Typ.)	27dB Typ.	17dB Min. (25dB Typ.)	1W Max. (CW)	-35 to +85 deg.C

All the technical data and information contained herein are subject to change without notice.

FOOT PATTERN

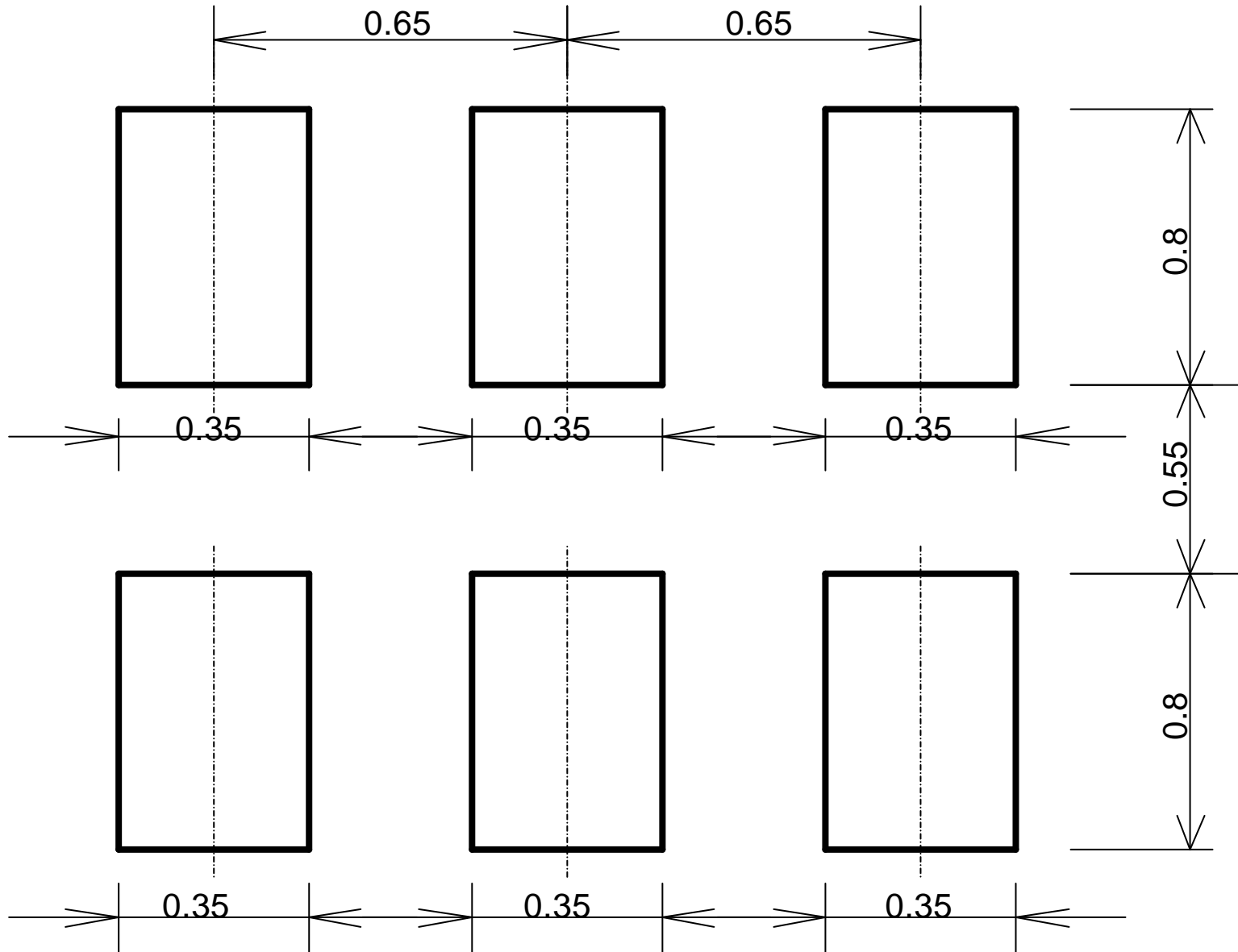

www.DataSheet4U.com

All the technical data and information contained herein are subject to change without notice.

LC-FSLC-S090M-A1-0406A
www.DataSheet4U.com

FSLC-S090M-A1 Sample Data

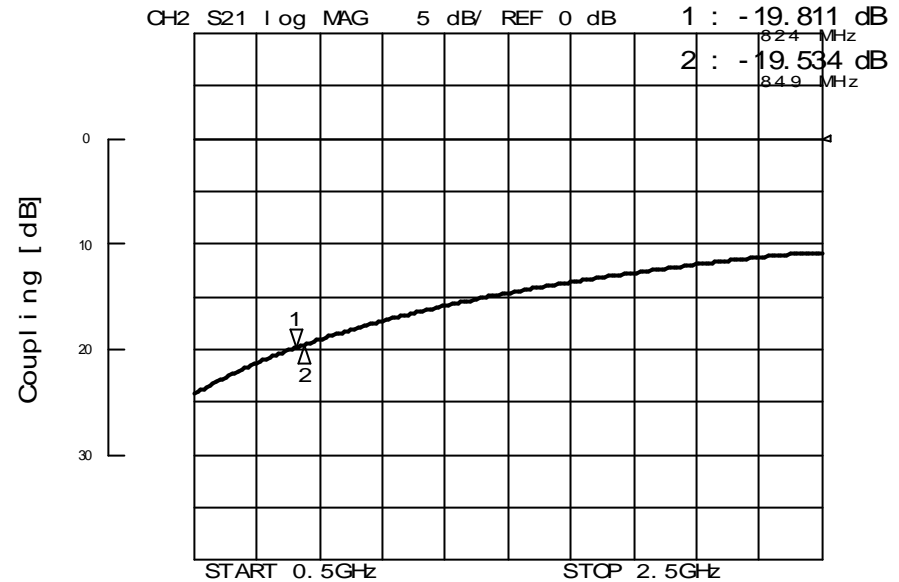
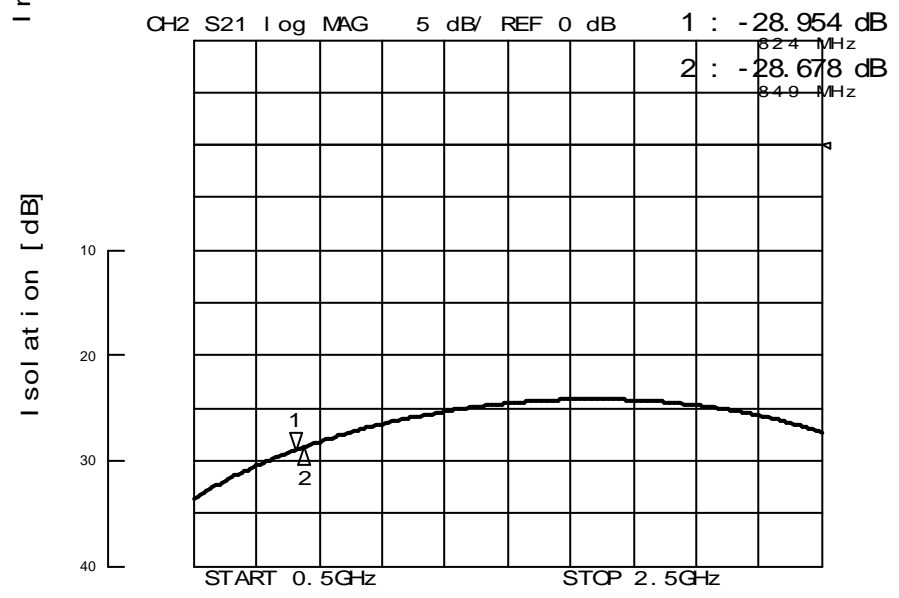
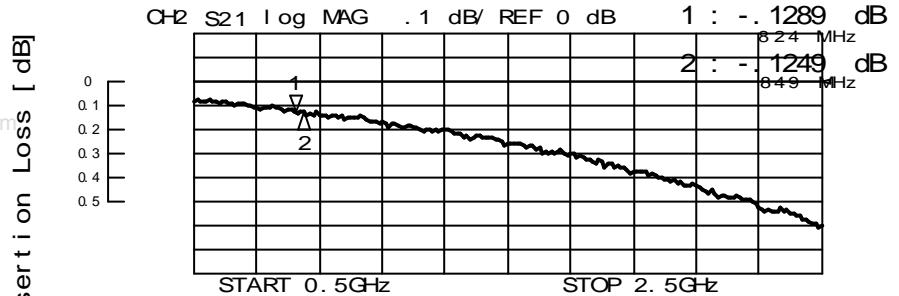
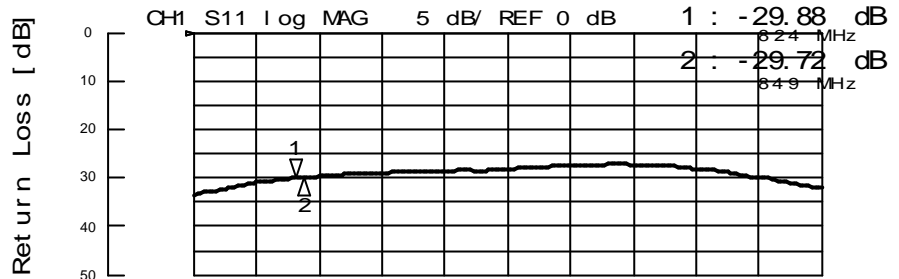

800/850 MHz
Chip Multilayer Coupler "FSLC-S090M-A1"

