

2012 Size

925/960 MHz
Chip Multilayer Coupler

FSLC-S090S-P

www.DataSheet4U.com

All the technical data and information contained herein are subject to change without notice.



LC-FSLC-S090S-P-0406A
www.DataSheet4U.com

Equivalent Circuits

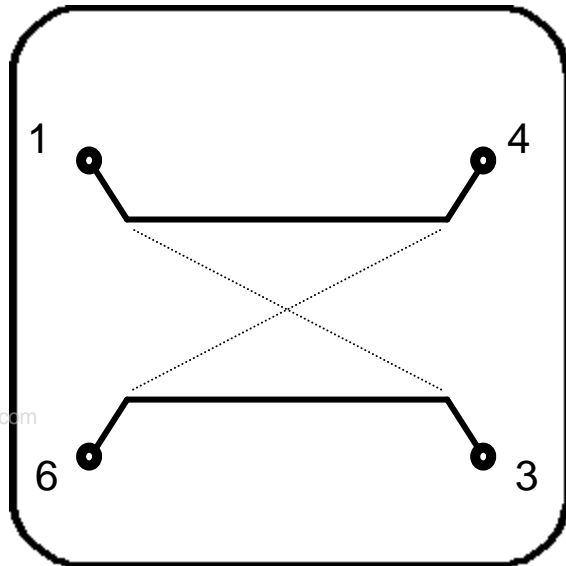

Shape & Size

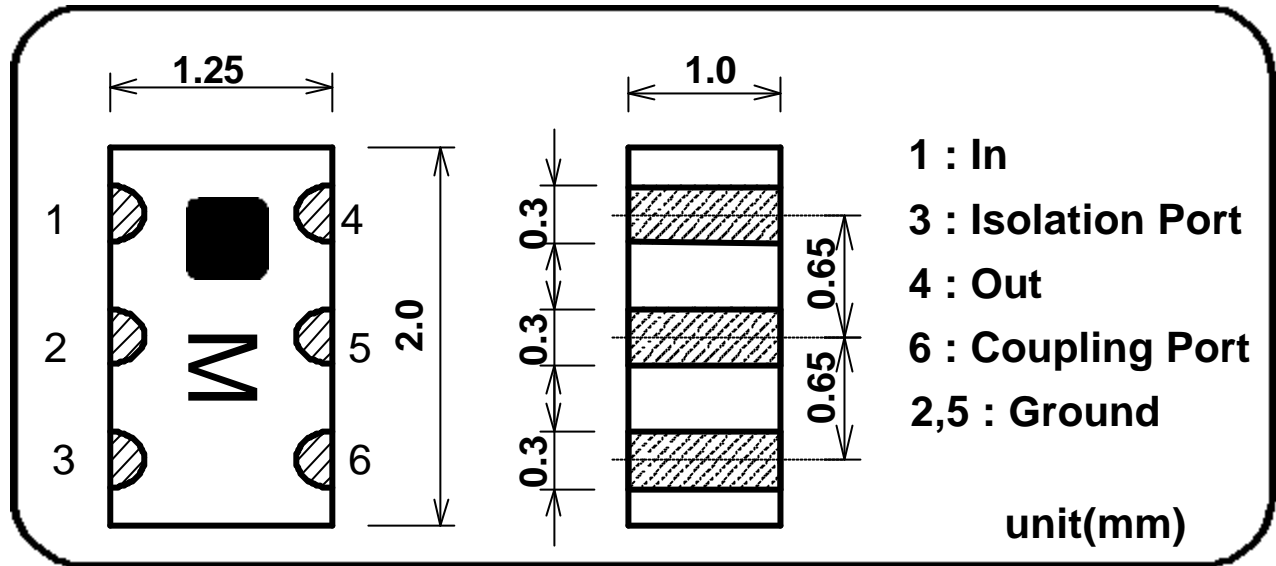

Specifications

Part Name: FSLC-S090S-P

Frequency Range	Coupling	Insertion Loss	Isolation	Return Loss	Handling Power	Temperature Range
925-960MHz	14.3 +/- 1dB	0.5dB Max. (0.25dB Typ.)	24dB Typ.	17dB Min. (22dB Typ.)	1W Max. (CW)	-35 to +85 deg.C

All the technical data and information contained herein are subject to change without notice.

FOOT PATTERN

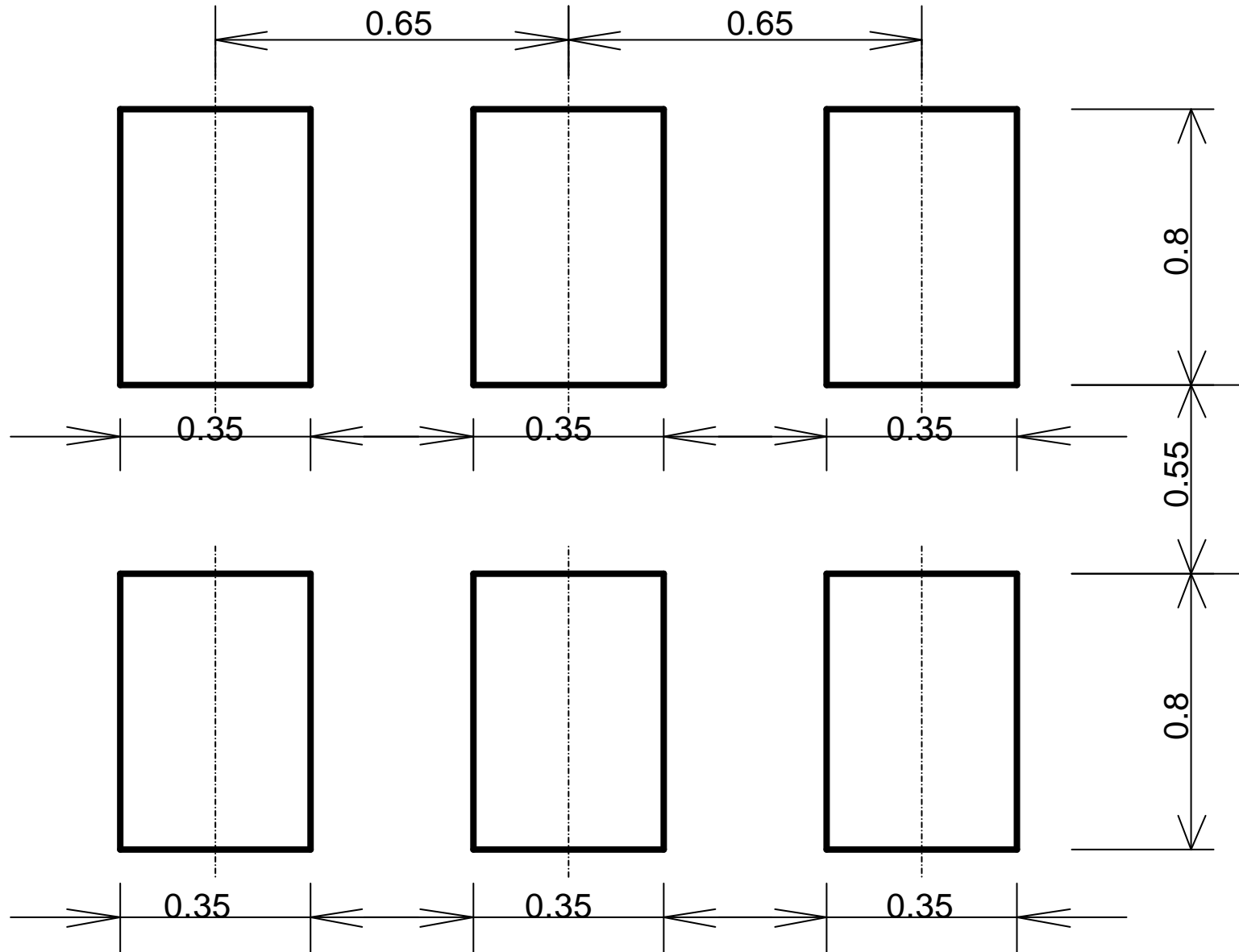

www.DataSheet4U.com

All the technical data and information contained herein are subject to change without notice.

LC-FSLC-S090S-P-0406A
www.DataSheet4U.com

FSLC-S090S-P Sample Data

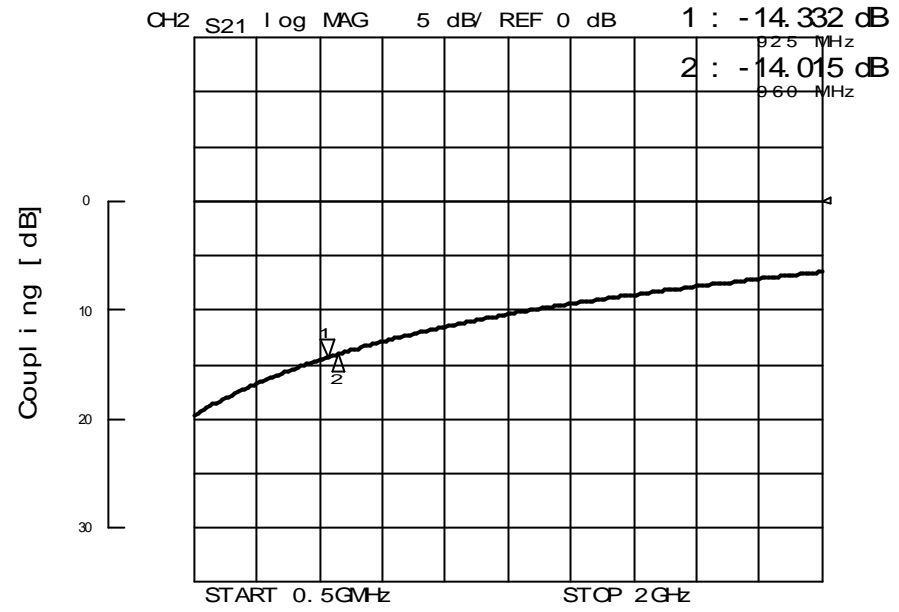
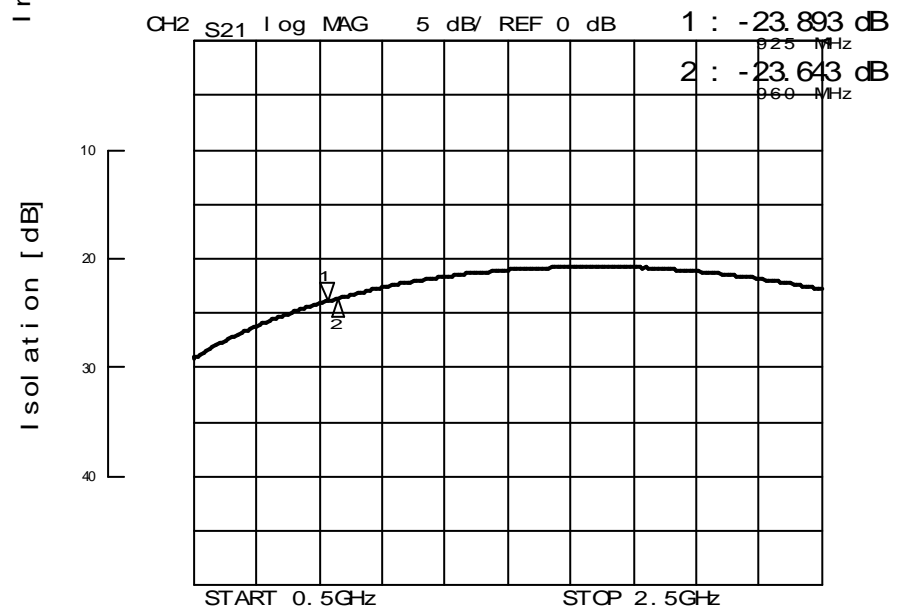
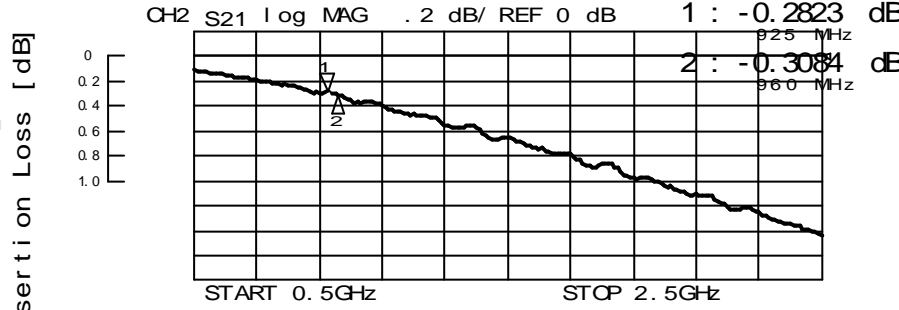
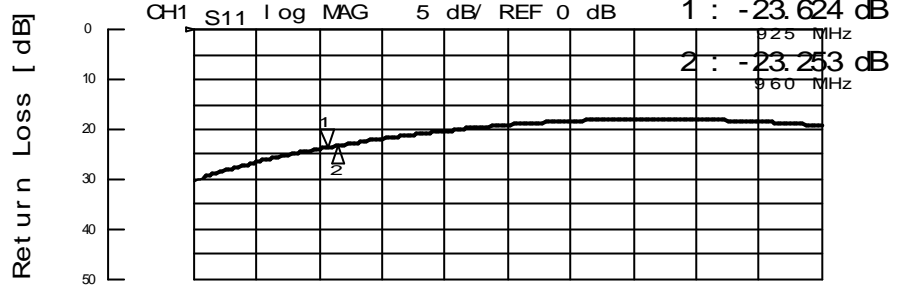

925/960 MHz
 Chip Multilayer Coupler "FSLC-S090S-P"

