

2012 Size

1.92/1.98GHz Band
Chip Multilayer Coupler

FSLC-S190N-W

www.DataSheet4U.com

All the technical data and information contained herein are subject to change without notice.



LC-FSLC-S190N-W-0408A www.DataSheet4U.com

Equivalent Circuits

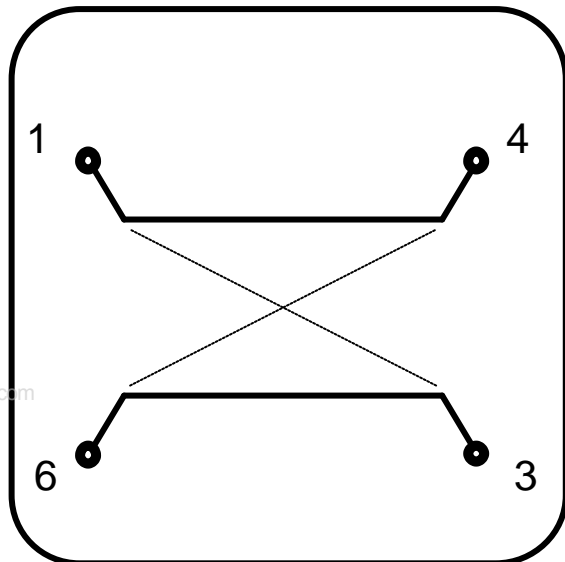

Shape & Size

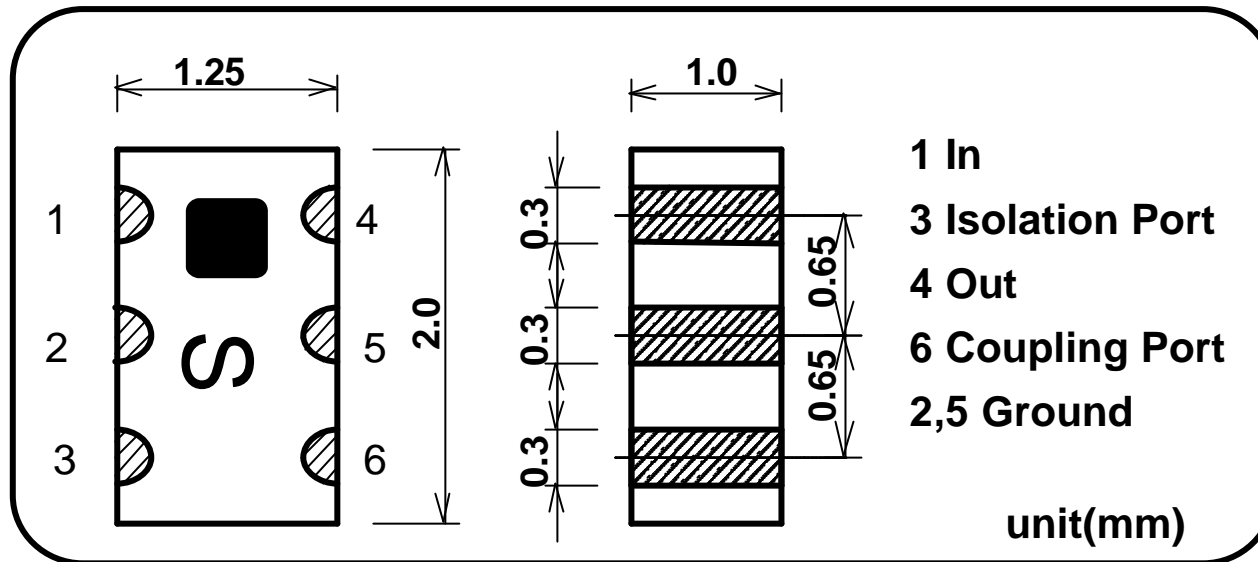

Specifications

P/N: FSLC-S190N-W

Frequency Range(MHz)	Coupling	Insertion Loss	Isolation	Return Loss	Handling Power	Temperature Range
1920-1980	14.0 +/- 1.5dB	0.7dB Max. (0.4dB Typ.)	24dB Typ.	17dB Min. (27dB Typ.)	1W Max. (CW)	-35 to +85 deg.C

All the technical data and information contained herein are subject to change without notice.

FSLC-S190N-W Sample Data

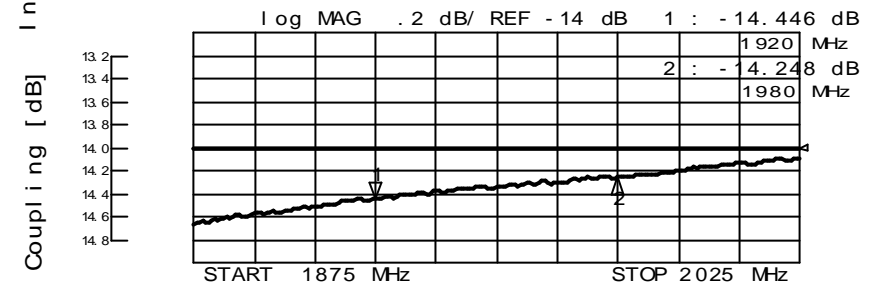
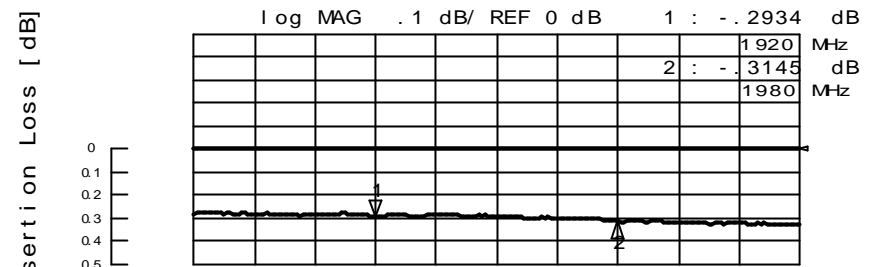
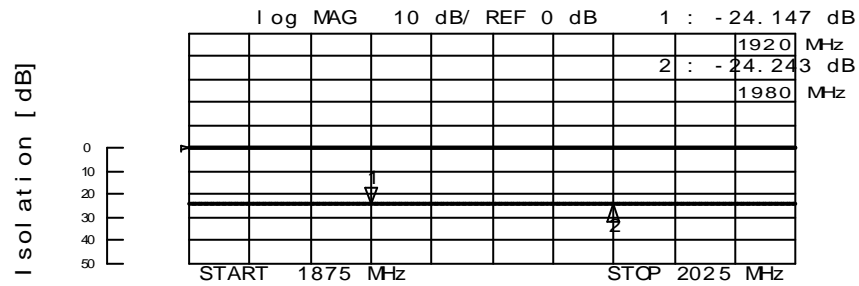
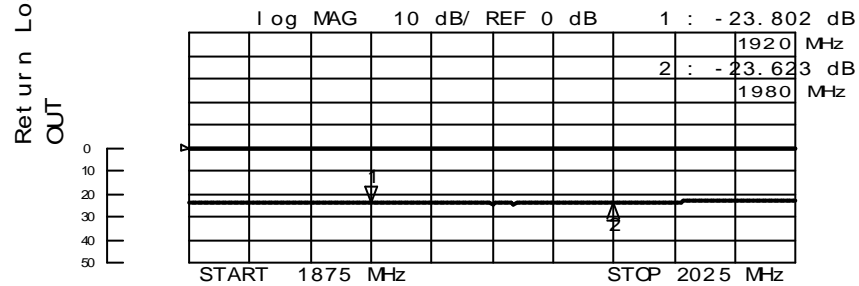
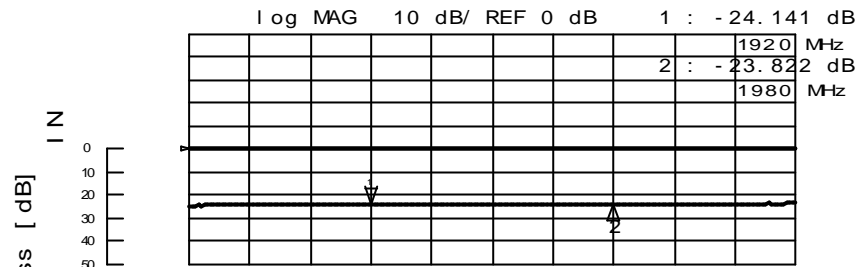

1.92/1.98GHz Band Chip Multilayer Coupler FSLC-S190N-W

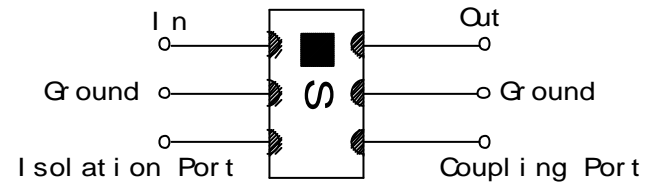

All the technical data and information contained herein are subject to change without notice.

FOOT PATTERN

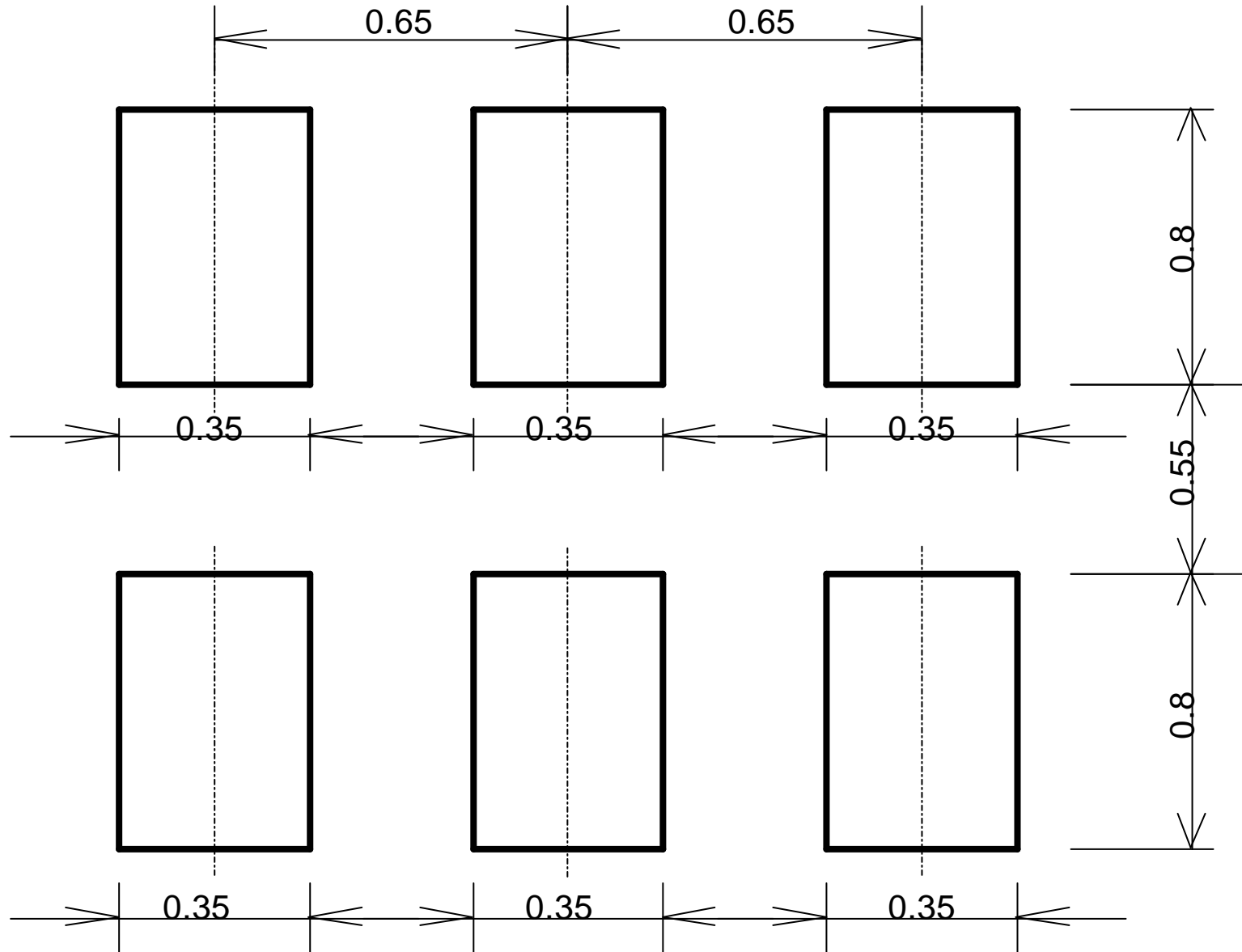

www.DataSheet4U.com

All the technical data and information contained herein are subject to change without notice.