

# FSLV16211

## 24-Bit Bus Switch

### Features

- 5Ω switch connection between two ports
- Minimal propagation delay through the switch
- Low I<sub>CC</sub>
- Zero bounce in flow-through mode
- Packaged in Fine-Pitch Ball Grid Array (FBGA) and Thin Shrink Small Outline Package (TSSOP)

### Description

The FSLV16211 is a 24-bit, high-speed, low-voltage bus switch. The low on resistance of the switch allows inputs to be connected to outputs without adding propagation delay or generating additional ground bounce noise.

This device's design allows this part to be used as a 12-bit or 24-bit bus switch. When  $\overline{OE}1$  is LOW, Port 1A is connected to Port 1B. When  $\overline{OE}2$  is LOW, Port 2A is connected to Port 2B.

### Ordering Information

Part Number	Pb-Free	Operating Temperature Range	Package	Packing Method
FSLV16211GX	Yes	-40°C to 85°C	54-Ball, Fine-Pitch Ball Grid Array (FBGA), JEDEC MO-205, 5.5mm Wide	Tape and Reel
FSLV16211MTD	Yes	-40°C to 85°C	56-Lead, Thin Shrink Small Outline Package (TSSOP), JEDEC M0-153, 6.1mm Wide	Trays
FSLV16211MTDX	Yes	-40°C to 85°C	56-Lead, Thin Shrink Small Outline Package (TSSOP), JEDEC M0-153, 6.1mm Wide	Tape and Reel

### Application Diagram

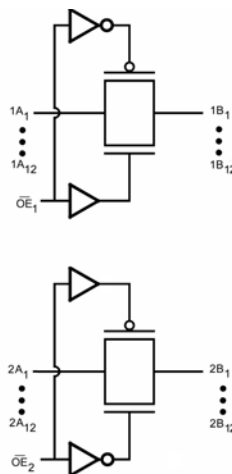

Figure 1. Logic Diagram

### Connection Diagram

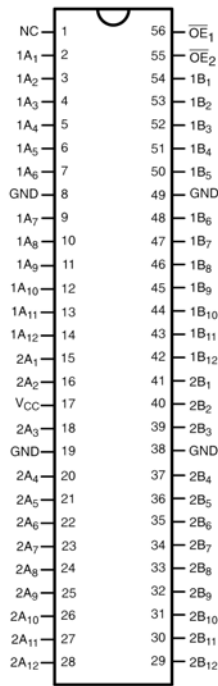

Figure 2. Pin Assignments for TSSOP (Top Through View)

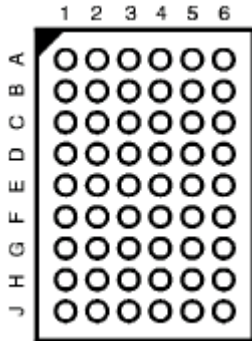

Figure 3. Pin Assignments for FBGA (Top Through View)

### Pin Description

Pin Name	Description
$\overline{OE}_1, \overline{OE}_2$	Bus Switch Enables
1A, 2A	Bus A
1B, 2B	Bus B
NC	No Connect

### FBGA Pin Assignments

	1	2	3	4	5	6
<b>A</b>	1A <sub>2</sub>	1A <sub>1</sub>	NC	OE <sub>2</sub>	1B <sub>1</sub>	1B <sub>2</sub>
<b>B</b>	1A <sub>4</sub>	1A <sub>3</sub>	1A <sub>7</sub>	OE <sub>1</sub>	1B <sub>3</sub>	1B <sub>4</sub>
<b>C</b>	1A <sub>6</sub>	1A <sub>5</sub>	GND	1B <sub>7</sub>	1B <sub>5</sub>	1B <sub>6</sub>
<b>D</b>	1A <sub>10</sub>	1A <sub>9</sub>	1A <sub>8</sub>	1B <sub>8</sub>	1B <sub>9</sub>	1B <sub>10</sub>
<b>E</b>	1A <sub>12</sub>	1A <sub>11</sub>	2A <sub>1</sub>	2B <sub>1</sub>	1B <sub>11</sub>	1B <sub>12</sub>
<b>F</b>	2A <sub>4</sub>	2A <sub>3</sub>	2A <sub>2</sub>	2B <sub>2</sub>	2B <sub>3</sub>	2B <sub>4</sub>
<b>G</b>	2A <sub>6</sub>	2A <sub>5</sub>	VCC	GND	2B <sub>5</sub>	2B <sub>6</sub>
<b>H</b>	2A <sub>8</sub>	2A <sub>7</sub>	2A <sub>9</sub>	2B <sub>9</sub>	2B <sub>7</sub>	2B <sub>8</sub>
<b>I</b>	2A <sub>12</sub>	2A <sub>11</sub>	2A <sub>10</sub>	2B <sub>10</sub>	2B <sub>11</sub>	2B <sub>12</sub>

### Truth Table

Inputs		Inputs/Outputs	
$\overline{OE}_1$	$\overline{OE}_2$	1A,1B	2A, 2B
Low	Low	1A=1B	2A=2B
Low	High	1A=1B	Z
High	Low	Z	2A=2B
High	High	Z	Z

## Absolute Maximum Ratings

Stresses exceeding the absolute maximum ratings may damage the device. The device may not function or be operable above the recommended operating conditions and stressing the parts to these levels is not recommended. In addition, extended exposure to stresses above the recommended operating conditions may affect device reliability. The absolute maximum ratings are stress ratings only.

Symbol	Parameter	Min.	Max.	Unit
$V_{CC}$	Supply Voltage	-0.5	4.6	V
$V_S$	DC Switch Voltage <sup>(1)</sup>	-0.5	4.6	V
$V_{IN}$	DC Input Voltage	-0.5	4.6	V
$I_{IK}$	DC Input Diode Current		-50	mA
$I_{OUT}$	DC Output Sink Current		128	mA
$I_{CC}/I_{GND}$	DC $V_{CC}/GND$ Current		+/-100	mA
$T_{STG}$	Storage Temperature Range	-65	150	°C

**Note:**

- The input and output negative voltage ratings may be exceeded if the input and output diode current ratings are observed.

## Recommended Operating Conditions

The Recommended Operating Conditions table defines the conditions for actual device operation. Recommended operating conditions are specified to ensure optimal performance to the datasheet specifications. Fairchild does not recommend exceeding them or designing to Absolute Maximum Ratings.<sup>(2)</sup>

Symbol	Parameter	Min.	Max.	Unit	
$V_{CC}$	Power Supply Operating	2.3	3.6	V	
$V_{IN}$	Input Voltage	0	3.6	V	
$V_{OUT}$	Output Voltage	0	3.6	V	
$t_r, t_f$	Input Rise and Fall Time	Switch Control Input	0	4.0	ns/V
		Switch I/O	0	DC	ns/V
$T_A$	Free Air Operating Temperature	-40	85	°C	

**Note:**

- Unused control inputs must be held HIGH or LOW. They may not float.

## DC Electrical Characteristics

Not all conditions may appear on all switch types.

Symbol	Parameter	Conditions	V <sub>CC</sub> (V)	T <sub>A</sub> = -40°C to +85°C			Units
				Min.	Typ.	Max.	
V <sub>IK</sub>	Clamp Diode Voltage	I <sub>IN</sub> = -18mA	3.0			-1.2	V
V <sub>IH</sub>	HIGH Level Control Input Voltage		2.3-2.7	1.7			V
			2.7-3.6	2.0			
V <sub>IL</sub>	LOW Level Control Input Voltage		2.3-2.7			0.7	V
			2.7-3.6			0.8	
I <sub>L</sub>	Input Leakage Current	Force V <sub>I</sub> = 3.6V, I <sub>OUT</sub> = 0.0A	2.3			10.0	μA
		Force V <sub>I</sub> = 3.6V	0.0			10.0	
		0 ≤ V <sub>IN</sub> ≤ 3.6V	3.6			1.0	
I <sub>CC</sub>	Quiescent Supply Current	V <sub>IN</sub> = V <sub>CC</sub> or GND, I <sub>OUT</sub> = 0A	3.6			10.0	μA
ΔI <sub>CC</sub>	Increase in I <sub>CC</sub> per Input	One Input at 3V Other Inputs at V <sub>CC</sub> or GND	3.6			300.0	μA
I <sub>OZ</sub>	Off-State Leakage	0.0 ≤ A, B ≤ 3.6V	3.6	-1.0		1.0	μA
R <sub>ON</sub>	Switch On Resistance	I <sub>IN</sub> = 64mA, V <sub>I</sub> = 0.0V	3.0		5.0	7.0	Ω
		I <sub>IN</sub> = 30mA, V <sub>I</sub> = 0.0V	3.0		5.0	7.0	
		I <sub>IN</sub> = 15mA, V <sub>I</sub> = 2.4V	3.0		10.0	15.0	
		I <sub>IN</sub> = 15mA, V <sub>I</sub> = 3.0V	2.3			20.0	
		I <sub>IN</sub> = 64mA, V <sub>I</sub> = 0.0V	2.3		5.0	8.0	
		I <sub>IN</sub> = 30mA, V <sub>I</sub> = 0.0V	2.3		5.0	8.0	
		I <sub>IN</sub> = 15mA, V <sub>I</sub> = 1.7V	2.3		10.0	15.0	
		I <sub>IN</sub> = 15mA, V <sub>I</sub> = 2.0V	2.3			20.0	

## AC Electrical Characteristics

Symbol	Parameter	T <sub>A</sub> = -40°C to +85°C		T <sub>A</sub> = 40°C to +85°C		Units
		C <sub>L</sub> = 30pF, R <sub>L</sub> = 500Ω		C <sub>L</sub> = 50pF, R <sub>L</sub> = 500Ω		
		V <sub>CC</sub> = 2.5V ± 0.20V		V <sub>CC</sub> = 3.3V ± 0.30V		
		Min.	Max.	Min.	Max.	
t <sub>PHL</sub> , t <sub>PLH</sub>	Propagation Delay <sup>(3)</sup>		0.15		0.25	ns
t <sub>PHZ</sub> , t <sub>PLZ</sub>	Enable Time	0.5	4.7	1.0	7.0	ns
t <sub>PZH</sub> , t <sub>PZL</sub>	Disable Time	0.5	5.1	1.0	5.5	ns

### Note:

- This parameter is guaranteed by design, but is not production tested. The bus switch contributes no propagation delay other than the RC delay of the typical on resistance of the switch and the load capacitance, when driven by an ideal voltage source (zero output impedance).

## Capacitance

$T_A = +25^\circ\text{C}$ ,  $f = 1\text{MHz}$ , unless otherwise noted.

Symbols	Parameter	Conditions	Min.	Typ.	Max.	Units
$C_{IN}$	Control Pin Input Capacitance	$V_{CC} = 3.3\text{V}$		4.5		pF
$C_{I/O}$	Input/Output Capacitance	$V_{CC}, \overline{OE} = 3.3\text{V}$		18.0		pF

Capacitance is characterized, but not production tested.

## AC Loading Waveforms

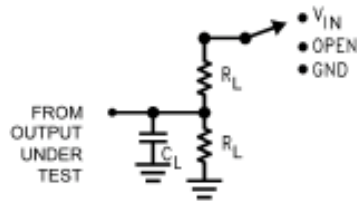

Note:  $C_L$  includes load and stray capacitance

Note: Input PRR = 1.0 MHz,  $t_W = 500\text{ns}$

TEST	SWITCH
$t_{PD}$	Open
$t_{PLZ}/t_{PZL}$	$V_{IN}$
$t_{PHZ}/t_{PZH}$	GND

Figure 4. AC Test Circuit

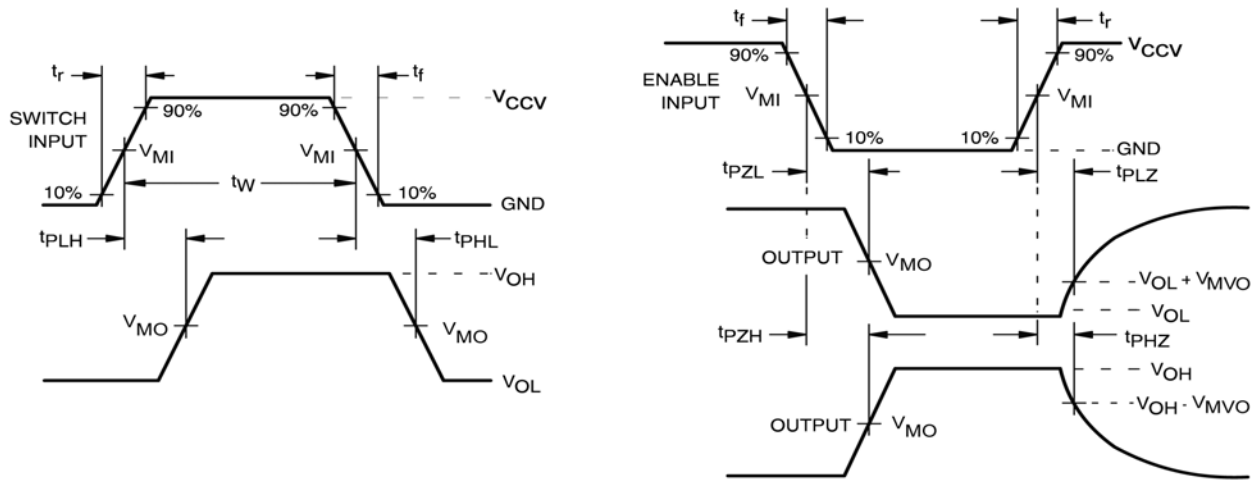
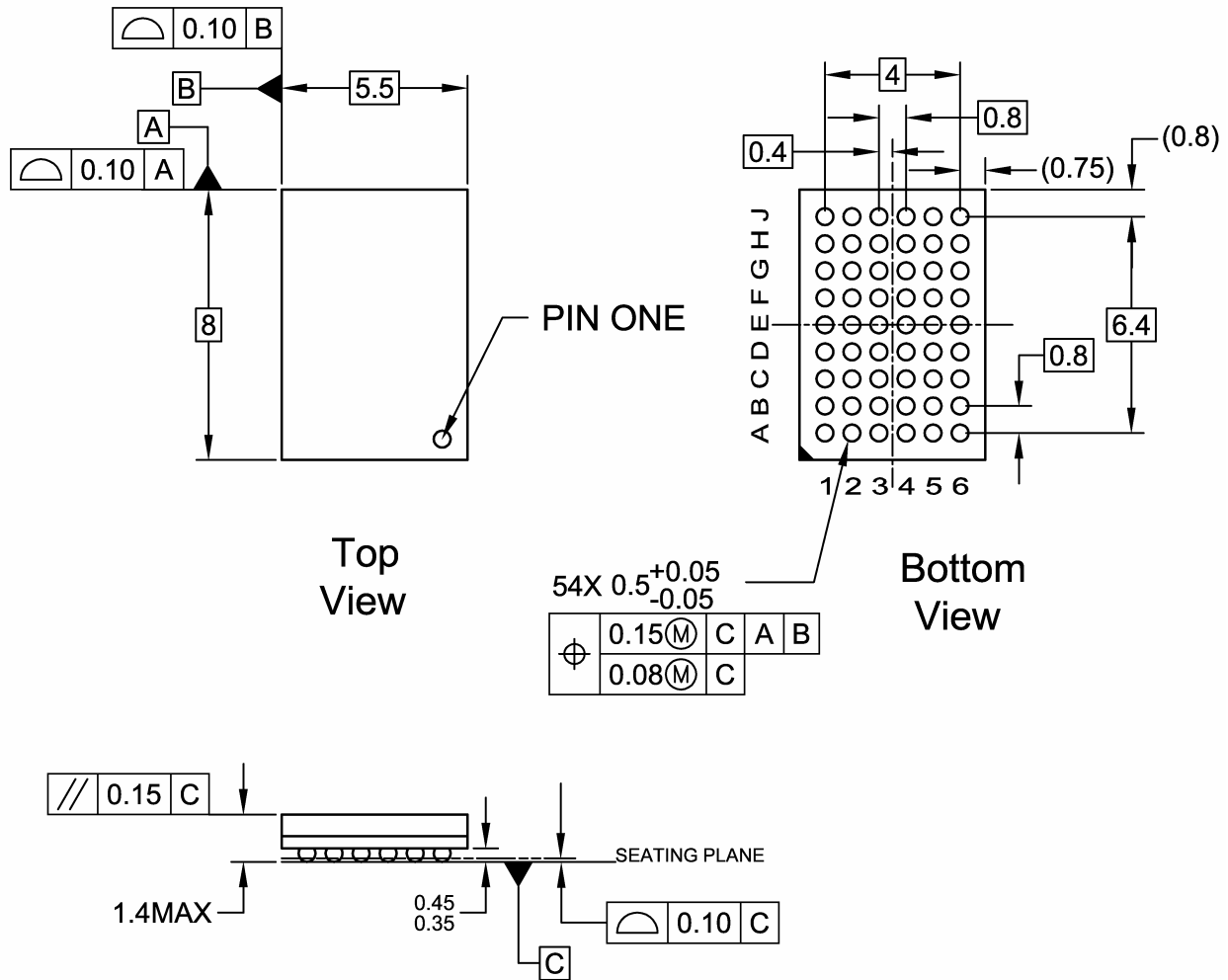

Figure 5. AC Waveforms

Symbol	$V_{CC}$	
	$3.3\text{V} \pm 0.3\text{V}$	$2.5\text{V} \pm 0.2\text{V}$
$V_{MI}$	1.5V	$V_{CC}/2$
$V_{MO}$	1.5V	$V_{CC}/2$
$V_{MVO}$	0.3V	0.15V
$V_{IN}$	6.0V	$2 \times V_{CC}$
$V_{CCV}$	3.0V	$V_{CC}$
$t_r/t_f$	2ns	2.5ns

## Physical Dimensions

Dimensions are in millimeters unless otherwise noted.



### NOTES:

- A. THIS PACKAGE CONFORMS TO JEDEC M0-205
- B. ALL DIMENSIONS IN MILLIMETERS
- C. LAND PATTERN RECOMMENDATION: NSMD (Non Solder Mask Defined)  
.35MM DIA PADS WITH A SOLDERMASK OPENING OF .45MM CONCENTRIC TO PADS
- D. DRAWING CONFORMS TO ASME Y14.5M-1994

BGA54ArevD

Figure 6. 54-Ball Fine-Pitch Ball Grid Array (FBGA), JEDEC MO-205, 5.5mm Wide

### Physical Dimensions (Continued)

Dimensions are in millimeters (inches) unless otherwise noted.

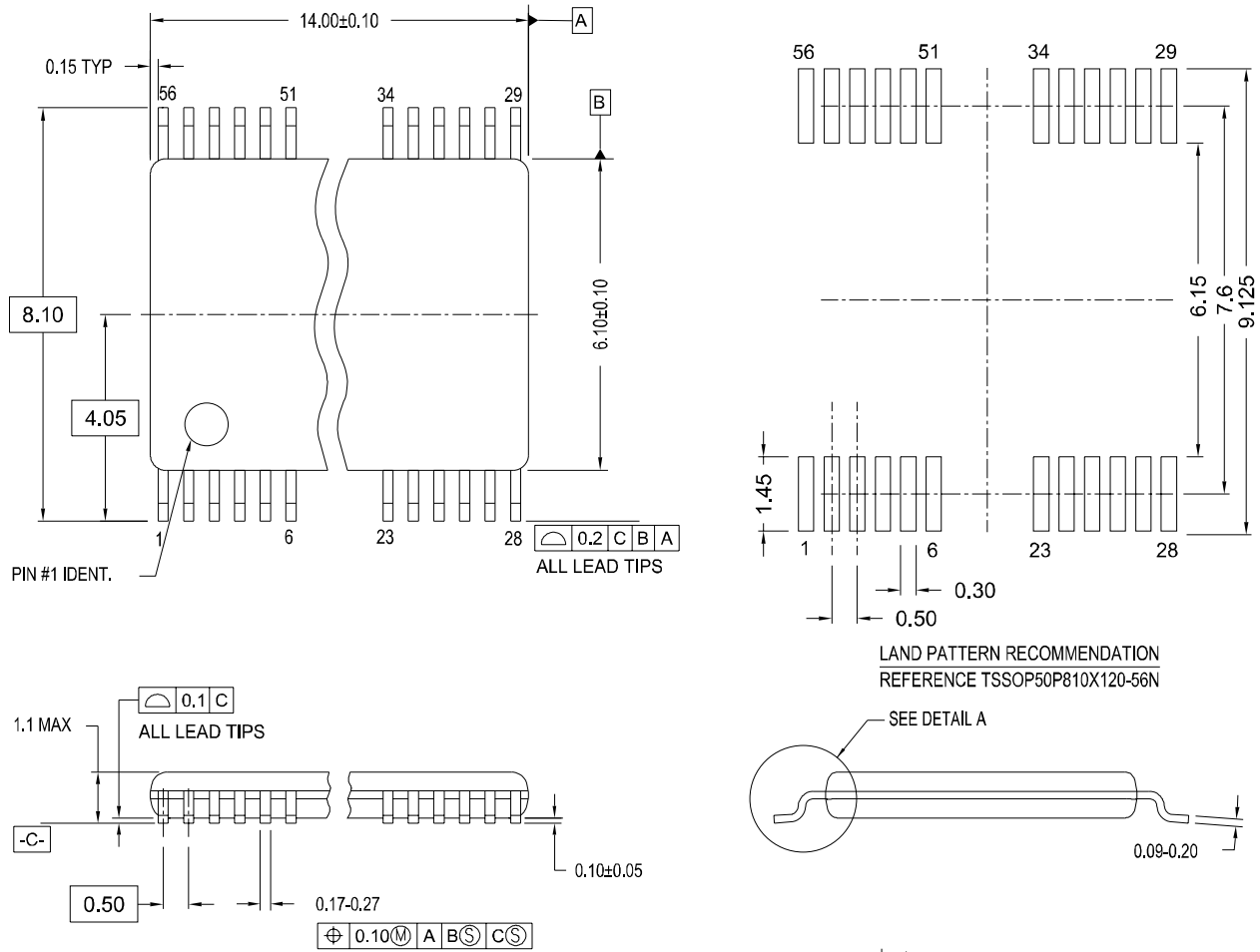

**NOTES:**

- A. CONFORMS TO JEDEC REGISTRATION MO-153, VARIATION EE, REF NOTE 6, DATE 10/97.
- B. DIMENSIONS ARE IN MILLIMETERS.
- C. DIMENSIONS ARE EXCLUSIVE OF BURRS, MOLD FLASH, AND TIE BAR EXTRUSIONS.
- D. DIMENSIONS AND TOLERANCES PER ANSI Y14.5M, 1982.
- E. DRAWING FILE NAME: MTD56REV3

MTD56REV3

DETAIL A

**Figure 7. 56-Lead Thin-Shrink Small Outline Package (TSSOP), JEDEC MO153, 6.1mm Wide**



### TRADEMARKS

The following are registered and unregistered trademarks Fairchild Semiconductor owns or is authorized to use and is not intended to be an exhaustive list of all such trademarks.

ACEx <sup>®</sup>	HiSeCT <sup>™</sup>	Programmable Active Droop <sup>™</sup>	TinyLogic <sup>®</sup>
Across the board. Around the world. <sup>™</sup>	<i>i-Lo</i> <sup>™</sup>	QFET <sup>®</sup>	TINYOPTO <sup>™</sup>
ActiveArray <sup>™</sup>	ImpliedDisconnect <sup>™</sup>	QST <sup>™</sup>	TinyPower <sup>™</sup>
Bottomless <sup>™</sup>	IntelliMAX <sup>™</sup>	QT Optoelectronics <sup>™</sup>	TinyWire <sup>™</sup>
Build it Now <sup>™</sup>	ISOPLANAR <sup>™</sup>	Quiet Series <sup>™</sup>	TruTranslation <sup>™</sup>
CoolFET <sup>™</sup>	MICROCOUPLER <sup>™</sup>	RapidConfigure <sup>™</sup>	μSerDes <sup>™</sup>
CROSSVOLT <sup>™</sup>	MicroPak <sup>™</sup>	RapidConnect <sup>™</sup>	UHC <sup>®</sup>
CTL <sup>™</sup>	MICROWIRE <sup>™</sup>	ScalarPump <sup>™</sup>	UniFET <sup>™</sup>
Current Transfer Logic <sup>™</sup>	MSX <sup>™</sup>	SMART START <sup>™</sup>	VCX <sup>™</sup>
DOME <sup>™</sup>	MSXPro <sup>™</sup>	SPM <sup>®</sup>	Wire <sup>™</sup>
E <sup>2</sup> CMOS <sup>™</sup>	OCX <sup>™</sup>	STEALTH <sup>™</sup>	
EcoSPARK <sup>®</sup>	OCXPro <sup>™</sup>	SuperFET <sup>™</sup>	
EnSigna <sup>™</sup>	OPTOLOGIC <sup>®</sup>	SuperSOT <sup>™</sup> -3	
FACT Quiet Series <sup>™</sup>	OPTOPLANAR <sup>®</sup>	SuperSOT <sup>™</sup> -6	
FACT <sup>®</sup>	PACMAN <sup>™</sup>	SuperSOT <sup>™</sup> -8	
FAST <sup>®</sup>	POP <sup>™</sup>	SyncFET <sup>™</sup>	
FAST <sup>r</sup> <sup>™</sup>	Power220 <sup>®</sup>	TCM <sup>™</sup>	
FPS <sup>™</sup>	Power247 <sup>®</sup>	The Power Franchise <sup>®</sup>	
FRFET <sup>®</sup>	PowerEdge <sup>™</sup>	 ™	
GlobalOptoisolator <sup>™</sup>	PowerSaver <sup>™</sup>	TinyBoost <sup>™</sup>	
GTO <sup>™</sup>	PowerTrench <sup>®</sup>	TinyBuck <sup>™</sup>	

### DISCLAIMER

FAIRCHILD SEMICONDUCTOR RESERVES THE RIGHT TO MAKE CHANGES WITHOUT FURTHER NOTICE TO ANY PRODUCTS HEREIN TO IMPROVE RELIABILITY, FUNCTION OR DESIGN. FAIRCHILD DOES NOT ASSUME ANY LIABILITY ARISING OUT OF THE APPLICATION OR USE OF ANY PRODUCT OR CIRCUIT DESCRIBED HEREIN; NEITHER DOES IT CONVEY ANY LICENSE UNDER ITS PATENT RIGHTS, NOR THE RIGHTS OF OTHERS. THESE SPECIFICATIONS DO NOT EXPAND THE TERMS OF FAIRCHILD'S WORLDWIDE TERMS AND CONDITIONS, SPECIFICALLY THE WARRANTY THEREIN, WHICH COVERS THESE PRODUCTS.

### LIFE SUPPORT POLICY

FAIRCHILD'S PRODUCTS ARE NOT AUTHORIZED FOR USE AS CRITICAL COMPONENTS IN LIFE SUPPORT DEVICES OR SYSTEMS WITHOUT THE EXPRESS WRITTEN APPROVAL OF FAIRCHILD SEMICONDUCTOR CORPORATION.

As used herein:

1. Life support devices or systems are devices or systems which, (a) are intended for surgical implant into the body or (b) support or sustain life, and (c) whose failure to perform when properly used in accordance with instructions for use provided in the labeling, can be reasonably expected to result in a significant injury of the user.
2. A critical component in any component of a life support, device, or system whose failure to perform can be reasonably expected to cause the failure of the life support device or system, or to affect its safety or effectiveness.

### PRODUCT STATUS DEFINITIONS

#### Definition of Terms

Datasheet Identification	Product Status	Definition
Advance Information	Formative or In Design	This datasheet contains the design specifications for product development. Specifications may change in any manner without notice.
Preliminary	First Production	This datasheet contains preliminary data; supplementary data will be published at a later date. Fairchild Semiconductor reserves the right to make changes at any time without notice to improve design.
No Identification Needed	Full Production	This datasheet contains final specifications. Fairchild Semiconductor reserves the right to make changes at any time without notice to improve design.
Obsolete	Not In Production	This datasheet contains specifications on a product that has been discontinued by Fairchild Semiconductor. The datasheet is printed for reference information only.

Rev. I24