

■ FEATURES

- Low dropout voltage: 180mV at 300mA ($V_o=3.3V$)
- Quiescent current: Typ. 65 μA
- 2% Voltage Accuracy
- High PSRR: 70dB at 1KHz
- Thermal Shutdown
- Current Limiting
- Excellent line and load regulation
- Fast response
- Short circuit protection
- Low temperature coefficient
- Shutdown current: 0.5 μA
- Space saving USP6 package

■ APPLICATIONS

- Cordless phones
- Cellular phones
- Bluetooth earphones
- Digital Cameras
- Portable electronics
- WLANs
- MP3 players

■ PIN CONFIGURATION

(Bottom View)

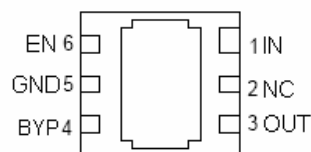

■ PIN DESCRIPTION

Pin Number	Pin Name	Pin Function
1	IN	Input
2	NC	Not connected
3	OUT	Output
4	BYP	Bypass pin, need a 10 μF capacitor connected to GND
5	GND	Ground
6	EN	Chip Enable (active high)

■ BLOCK DIAGRAM

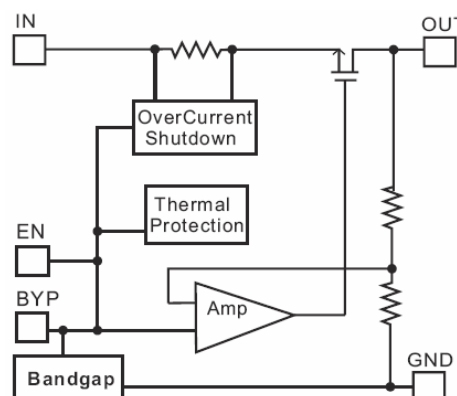

■ TYPICAL APPLICATIONS CIRCUITS

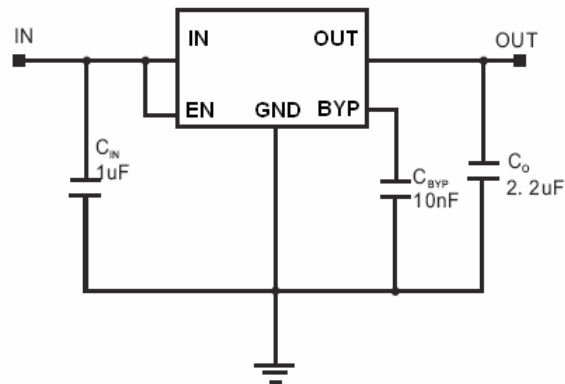

■ ABSOLUTE MAXIMUM RATINGS

Parameter	Rating	Unit
Input Supply Voltage	+6	V
Output Current	300	mA
Output Pin Voltage	GND-0.3 to VIN+0.3	V
ESD Rating	Class B	
Internal Power Dissipation	100	mW
Operating temperature	-40 to 85	°C
Operating Junction Temperature	-40 to 125	°C
Storage Temperature	-65 to 150	°C
Lead Temperature (Soldering, 5 sec)	300	°C

Note: Absolute Maximum Ratings are those values beyond which the life of a device may be impaired.

■ ELECTRICAL CHARACTERISTICS

($V_{IN} = V_O + 1V$, $C_{IN} = 1\mu F$, $C_O = 2.2\mu F$, $T_A = 25^\circ C$ unless otherwise specified.)

PARAMETER	SYMBOL	TEST CONDITIONS	MIN	TYP	MAX	UNIT	
Input Voltage	V_{IN}		Note1		5.5	V	
Output Voltage Accuracy	V_O	$I_O = 1mA$	-2		+2	%	
Output Current	I_O		300		Note2	mA	
Ground Current	I_{GND}	$I_O = 1mA$ to 300mA		70	90	μA	
Quiescent Current	I_Q	$I_O = 0mA$		65	90	μA	
Line Regulation	LNR	$I_O = 1mA$, $V_O < 2V$ $V_{IN} = 2.8V$ to $3.8V$	-0.15	0.1	0.15	%V	
		$I_O = 1mA$, $2 \leq V_O < 3.3V$ $V_{IN} = V_O + 0.5V$ to $V_O + 1V$	-0.1	0.03	0.1		
		$I_O = 1mA$, $V_O \geq 3.3V$ $V_{IN} = V_O + 0.5V$ to $V_O + 1V$	-0.4	0.2	0.4		
Load Regulation Error	LDR	$I_O = 1mA$ to 300mA	-1	0.2	1	%	
Temperature Coefficient	T_C	$I_O = 1mA$		40		ppm/ $^\circ C$	
Over Temperature Shutdown	OTS	$I_O = 1mA$		150		$^\circ C$	
Over Temperature Hystersis	OTH	$I_O = 1mA$		30		$^\circ C$	
Power Supply Ripple Rejection (with bypass Cap.)	PSRR	$I_O = 100mA$ $C_{BYP} = 10nF$ $V_O = 1.8V$	$f = 100Hz$		70	dB	
			$f = 1KHz$		70		
			$f = 10KHz$		50		
Power Supply Ripple Rejection (without bypass Cap.)	PSRR	$I_O = 100mA$ $V_O = 1.8V$	$f = 100Hz$		70	dB	
			$f = 1KHz$		60		
			$f = 10KHz$		40		
Dropout Voltage	V_{DO}	$I_O = 300mA$	$V_O = 1.8V$		850	1100	mV
			$2.5 \leq V_O < 3.3V$		370	450	
			$V_O \geq 3.3V$		180	230	
EN Input High Threshold	V_{IH}	$V_{IN} = 2.5V$ to $5V$	1.5			V	
EN Input Low Threshold	V_{IL}	$V_{IN} = 2.5V$ to $5V$			0.3	V	
Output Noise	V_n	$C_{BYP} = 10nF$, $f = 10Hz$ to $100kHz$		50		μV_{RMS}	
Shutdown Current	I_{SD}	$V_{EN} = 0V$		0.01	1	μA	

Note 1: The minimum input voltage of the FSP2134 is determined by output voltage and dropout voltage. The minimum input voltage is defined as:

$$V_{IN(MIN)} = V_O + V_{DROP}$$

Note 2: Output current is limited by P_D , maximum $I_O = P_D / (V_{IN(MAX)} - V_O)$

■ APPLICATION INFORMATION

Capacitor Selection and Regulator Stability

Similar to any low dropout regulator, the external capacitors used with the FSP2134 must be carefully selected for regulator stability and performance.

Using a capacitor, C_{IN} , whose value is $> 1 \mu F$ at the FSP2134 input pin, the amount of the capacitance can be increased without limit. Please note that the distance between C_{IN} and the input pin of the FSP2134 should not exceed 0.5 inch. Ceramic capacitors are suitable for the FSP2134. Capacitors with larger values and lower ESR provide better PSRR and line-transient response.

The FSP2134 is designed specifically to work with low ESR ceramic output capacitors in order to save space and improve performance. Using an output ceramic capacitor whose value is $> 2.2 \mu F$ with $ESR > 5m\Omega$ ensure stability. A 10nF bypass capacitor connected to BYP pin is suggested for suppressing output noise. The capacitor, in series connection with an internal 200k Ω resistor, forms a low-pass filter for noise reduction. Increasing the capacitance will slightly decrease the output noise, but increase the start-up time.

Load Transient Considerations

The figure11 shows the FSP2134 load transient response. It shows two components the output response: a DC shift from the output impedance due to the load current change and transient response. The DC shift is quite small due to excellent load regulation of the FSP2134. The transient spike, resulting from a step change in the load current from 1mA to 300mA, is 20mV. The ESR of the output capacitor is critical to the transient spike. A larger capacitance along with smaller ESR results in a smaller spike.

Shutdown Input Operation

The FSP2134 is shutdown by pulling the EN input low, and is turned on by tying the EN input to VIN or leaving the EN input floating.

Internal P-Channel Pass Transistor

The FSP2134 features a 0.75 Ω P-Channel MOSFET device as a pass transistor. The P-MOS pass transistor enables the FSP2134 to consume only 65 μA of ground current during low dropout, light load, or heavy load operations. This feature increases the battery operation life time.

Dropout Voltage

A regulator's minimum dropout voltage determines the lowest usable supply voltage. The FSP2134 has a typical 300mV dropout voltage. In battery powered systems, this will determine the useful end-of-life battery voltage.

Current Limit and Short Circuit Protection

The FSP2134 features a current limit, which monitors and controls the gate voltage of the pass transistor. The output current can be limited to 400mA by regulating the gate voltage. The FSP2134 also has a built-in short circuit current limit.

■ TYPICAL PERFORMANCE CHARACTERISTICS

($V_{IN} = V_{EN}$, $C_{IN} = 1\mu\text{F}$, $C_O = 2.2\mu\text{F}$, $C_{BYP} = 10\text{nF}$, $T_A = 25^\circ\text{C}$ unless otherwise specified.)

1. Output Voltage vs Input Voltage

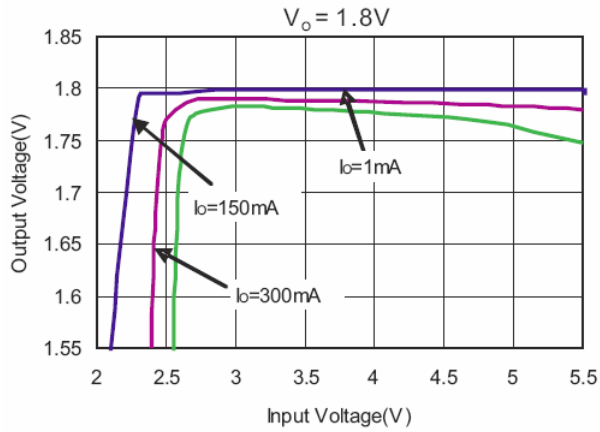

2. Output Voltage vs Output Current

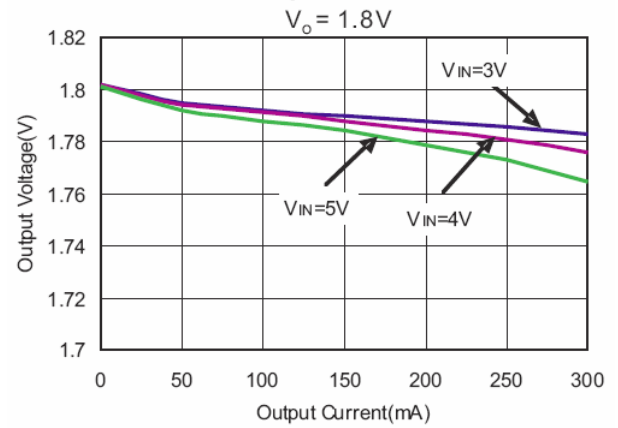
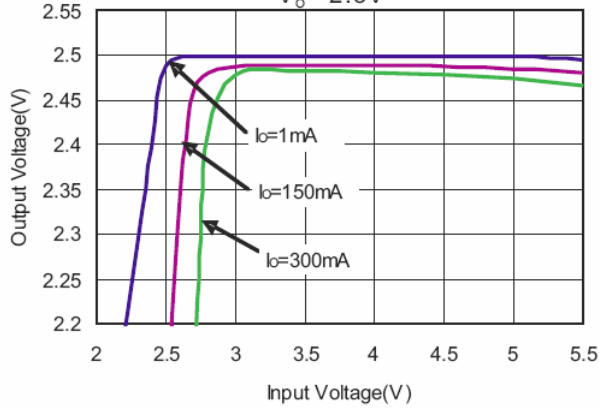
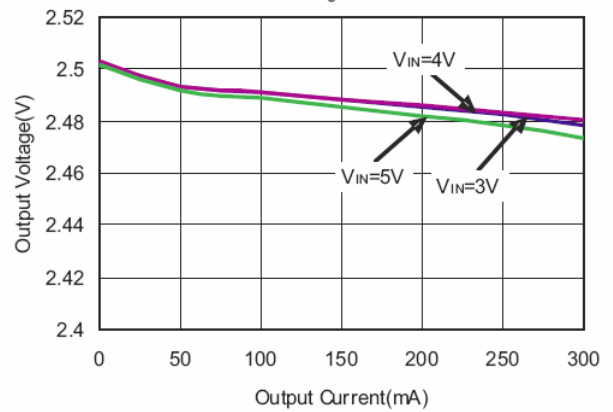
 $V_o = 2.5\text{V}$  $V_o = 2.5\text{V}$ 

www.DataSheet4U.com

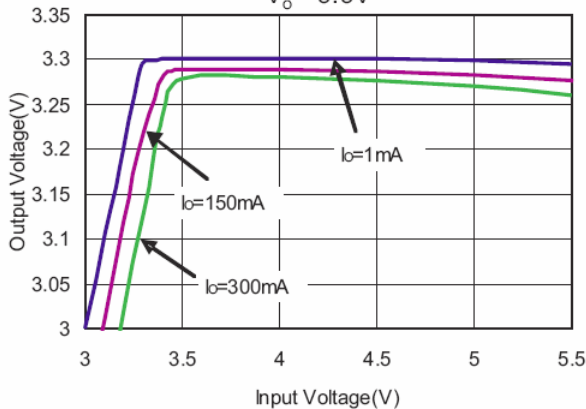
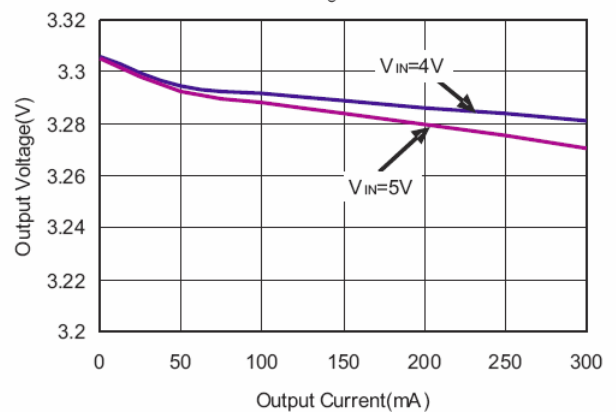
 $V_o = 3.3\text{V}$  $V_o = 3.3\text{V}$ 

■ TYPICAL PERFORMANCE CHARACTERISTICS (CONTINUED)

($V_{IN} = V_{EN}$, $C_{IN} = 1\mu\text{F}$, $C_O = 2.2\mu\text{F}$, $C_{BYP} = 10\text{nF}$, $T_A = 25^\circ\text{C}$ unless otherwise specified.)

3. Output Voltage vs Temperature

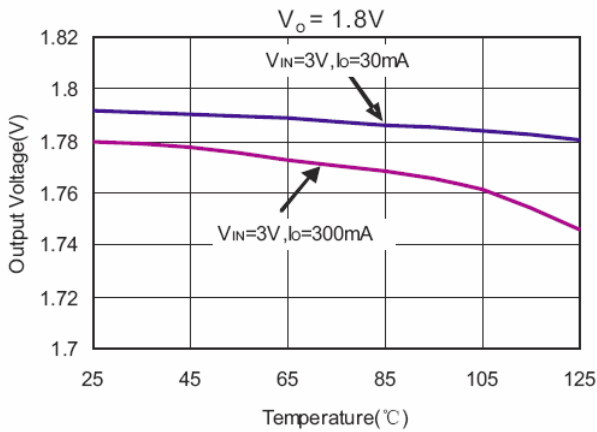

4. Ground Current vs Input Voltage

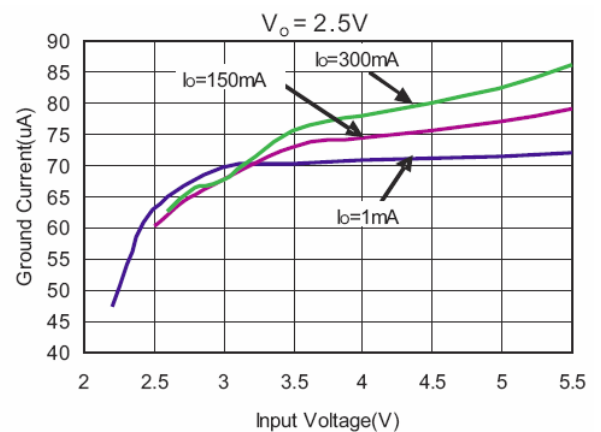
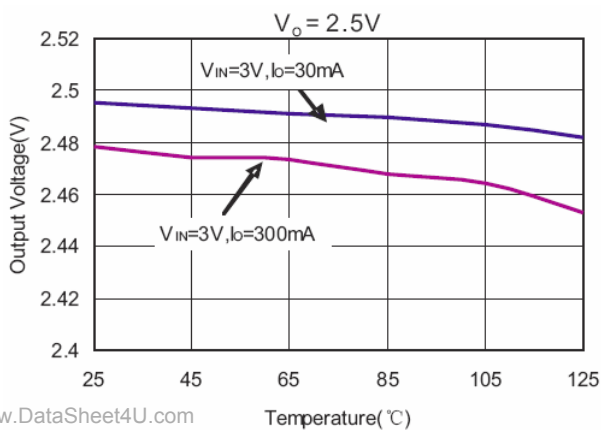
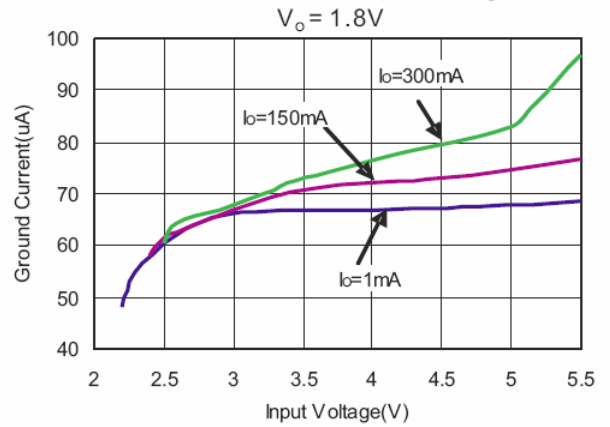

www.DataSheet4U.com

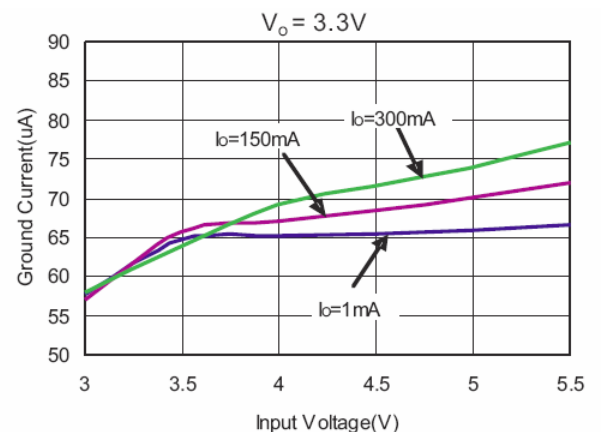
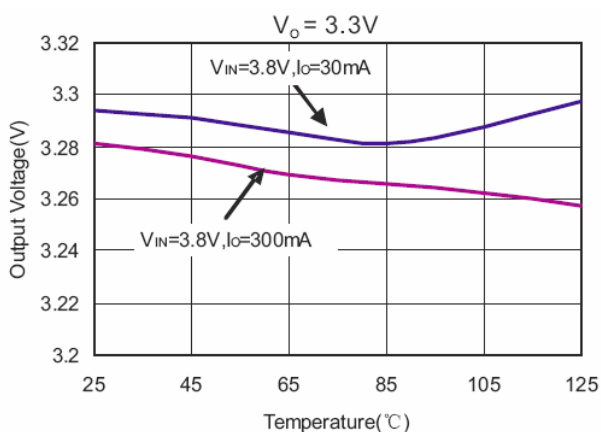

■ TYPICAL PERFORMANCE CHARACTERISTICS (CONTINUED)

($V_{IN} = V_{EN}$, $C_{IN} = 1\mu\text{F}$, $C_O = 2.2\mu\text{F}$, $C_{BYP} = 10\text{nF}$, $T_A = 25^\circ\text{C}$ unless otherwise specified.)

5. Dropout Voltage vs Output Current

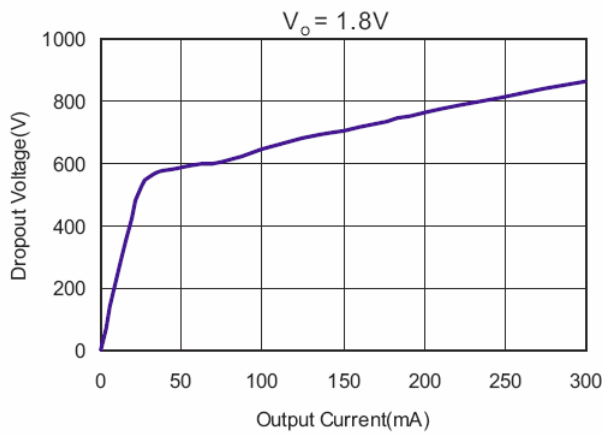

6. Dropout Voltage vs Temperature

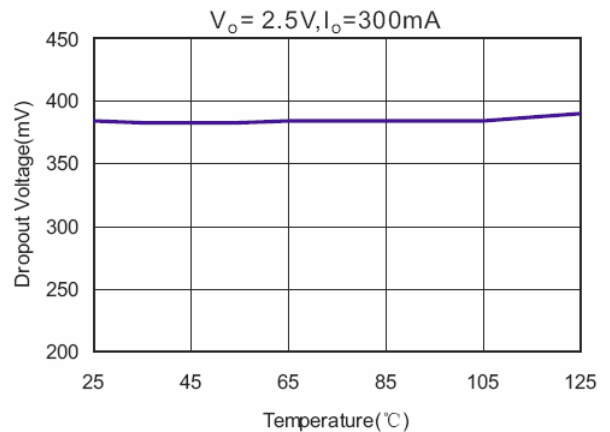
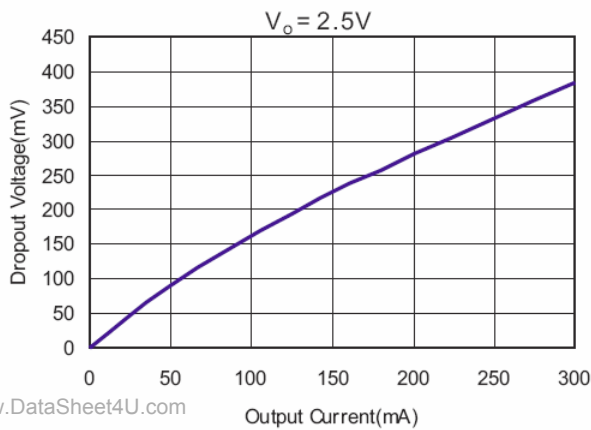
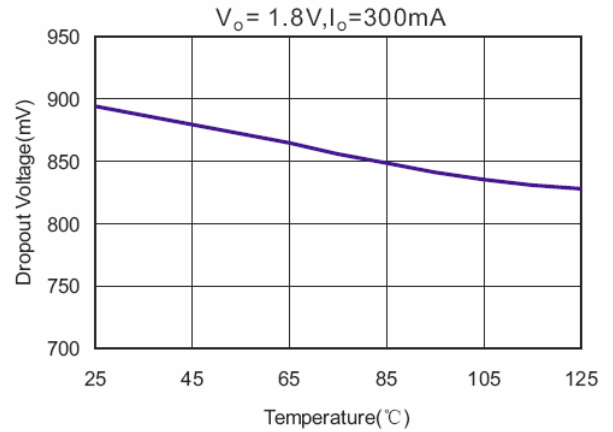

www.DataSheet4U.com

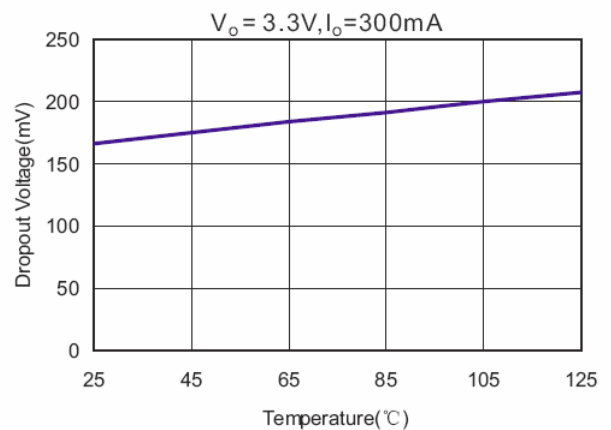
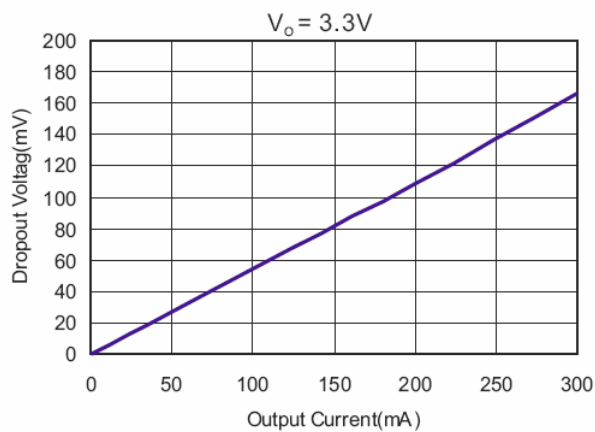

■ TYPICAL PERFORMANCE CHARACTERISTICS (CONTINUED)

($V_{IN} = V_{EN}$, $C_{IN} = 1\mu\text{F}$, $C_O = 2.2\mu\text{F}$, $C_{BYP} = 10\text{nF}$, $T_A = 25^\circ\text{C}$ unless otherwise specified.)

7. Quiescent Current vs Input Voltage

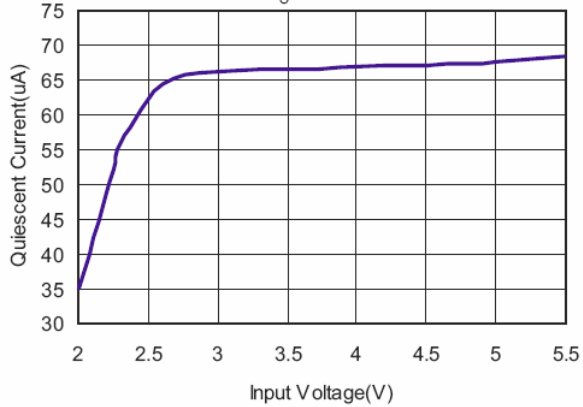
 $V_o = 1.8\text{V}$ 

8. Quiescent Current vs Temperature

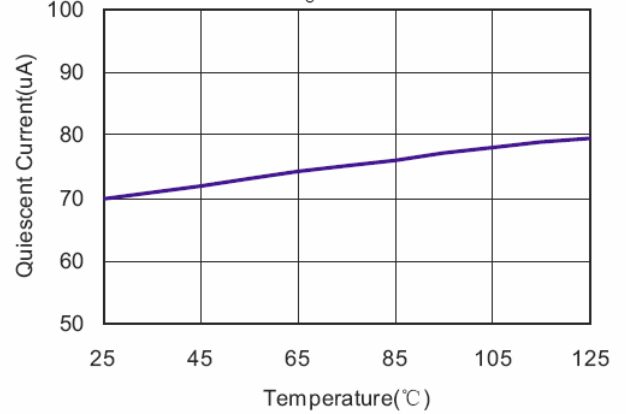
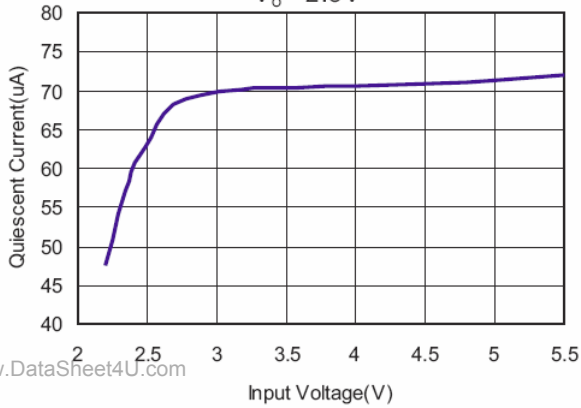
 $V_o = 1.8\text{V}$  $V_o = 2.5\text{V}$ 

www.DataSheet4U.com

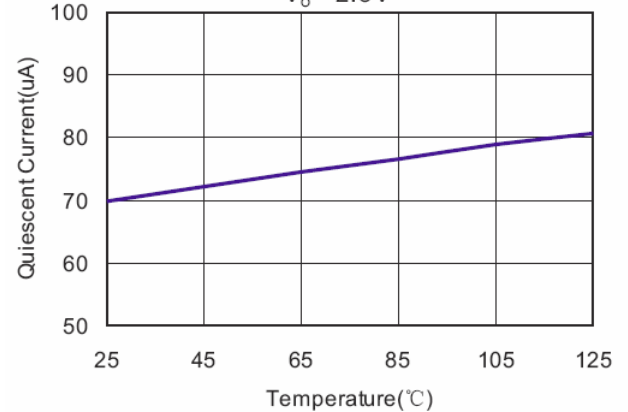
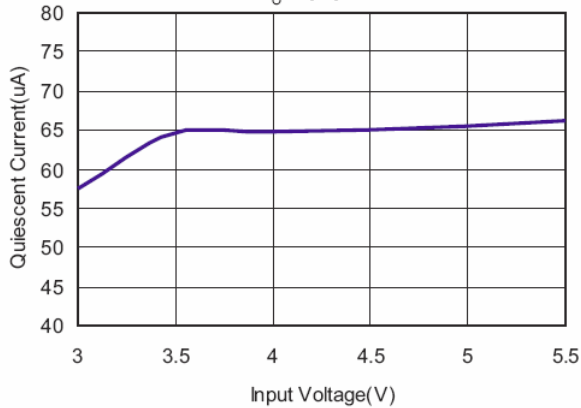
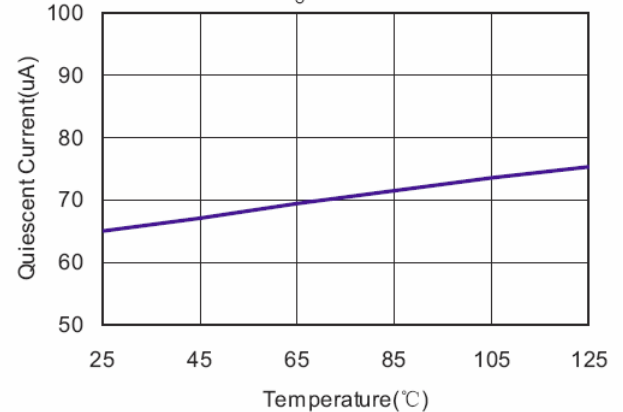
 $V_o = 2.5\text{V}$  $V_o = 3.3\text{V}$  $V_o = 3.3\text{V}$ 



300MA HIGH PSRR LOW DROPOUT CMOS LINEAR REGULATOR

FSP2134

TYPICAL PERFORMANCE CHARACTERISTICS (CONTINUED)

($V_{IN} = V_{EN}$, $C_{IN} = 1\mu F$, $C_O = 2.2\mu F$, $C_{BYP} = 10nF$, $T_A = 25^\circ C$ unless otherwise specified.)

9. Power Supply Ripple Rejection

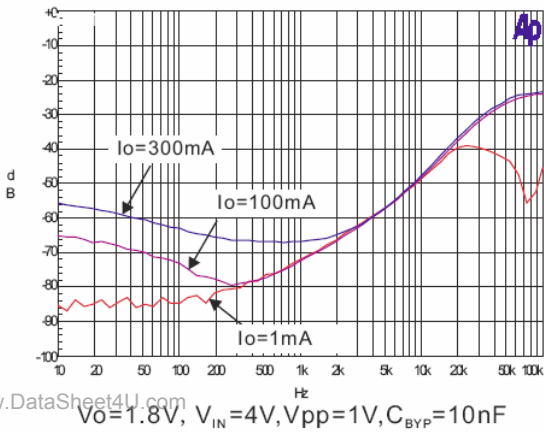
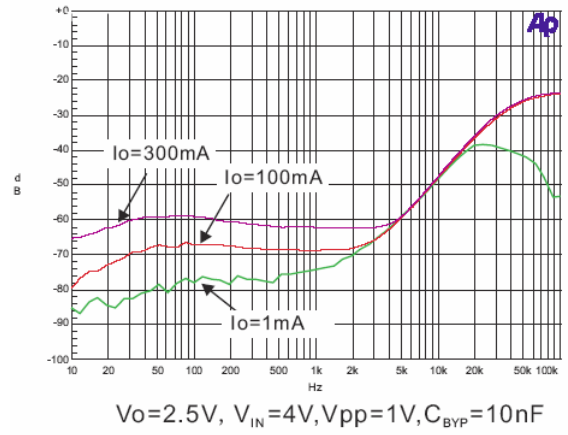
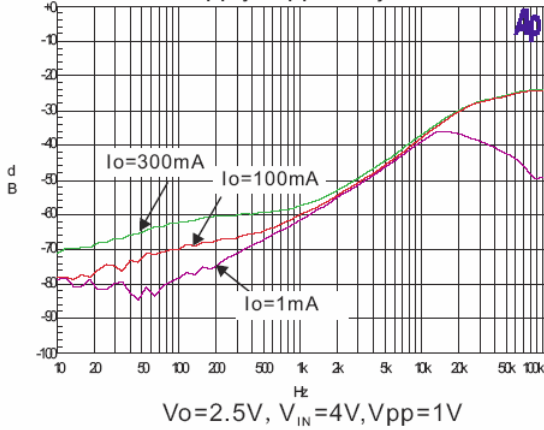

10. Load Transient Response

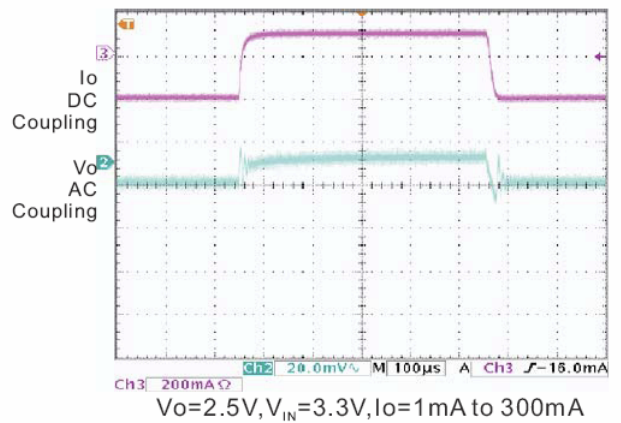

11. Line Transient Response

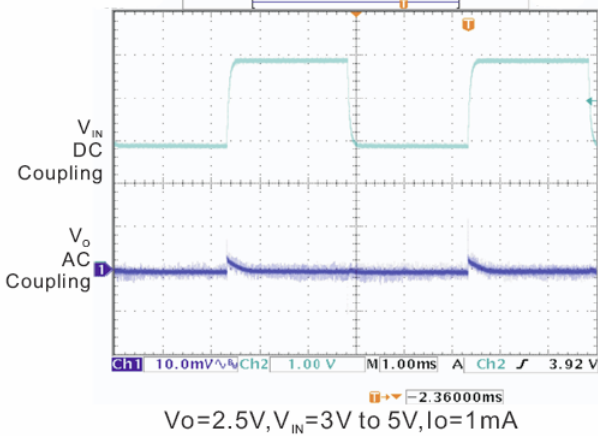

12. Turn-on Response

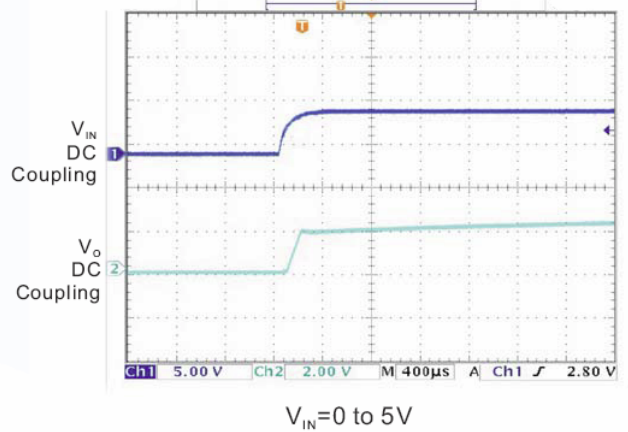

■ ORDERING INFORMATION

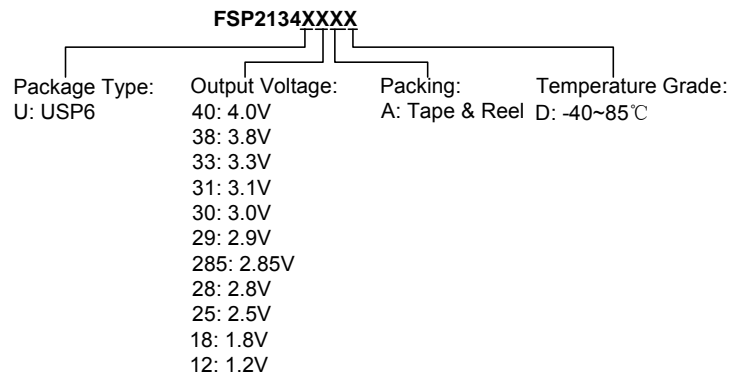

■ MARKING INFORMATION

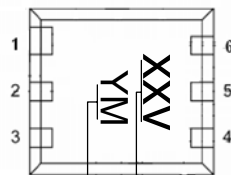

XX: Product code

V: Output voltage

T: 4.0V

S: 3.8V

J: 3.3V

R: 3.1V

I: 3.0V

Q: 2.9V

H: 2.85V

G: 2.8V

D: 2.5V

C: 1.8V

P: 1.2V

Date code:

Y: Year (1=2001)

M: Month (1~9, O, N, D)

■ PACKAGE INFORMATION

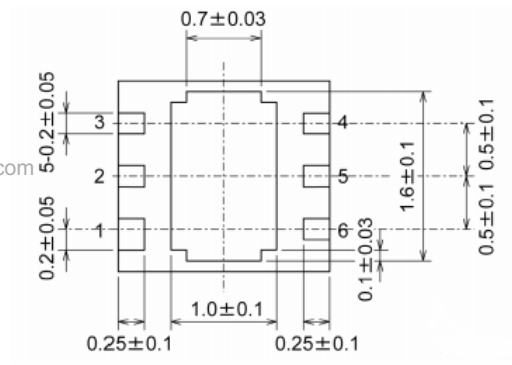
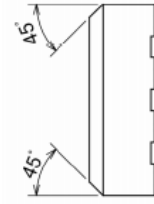
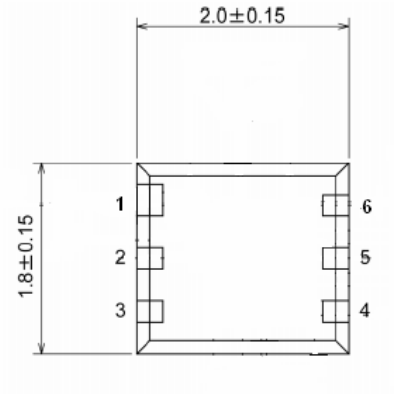

www.DataSheet4U.com

