

FSP2150
FEATURES

- 180mV Typical Dropout with 150mA Load
- $\pm 2.0\%$ Voltage Accuracy
- High PSRR: 70dB@100Hz
- Low noise output
- Current Limit
- Thermal Shutdown Protection
- Short Circuit Protection
- Very small SOT23-6L Package

APPLICATIONS

- Cellular Handsets
- Portable Electronics, PDA
- Wireless Devices, LAN
- Computer Peripherals
- Camera Module
- GPS Receiver

PIN CONFIGURATION

(Top View)

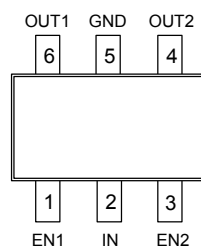
PIN DESCRIPTION

Pin Number	Pin Name	Pin Function
1	EN1	Output 1 Enable
2	VIN	Input
3	EN2	Output 2 Enable
4	OUT2	Output 2
5	GND	Ground
6	OUT1	Output 1

■ ABSOLUTE MAXIMUM RATINGS

Parameter	Rating	Unit
Input Voltage	6	V
Output Pin Voltage	GND-0.3 to VIN + 0.3	V
Output Current	150/150	mA
Internal Power Dissipation	400	mW
ESD Rating(HBM)	2000	V
Operating Junction Temperature	-40 to 125	°C
Operating Ambient Temperature	-40 to 85	°C
Storage Temperature	-40 to 125	°C
Lead Temperature (Soldering, 5 sec)	300	°C

Note: Absolute Maximum Ratings are those values beyond which the life of a device may be impaired

■ ELECTRICAL CHARACTERISTICS

(VIN = VOUT + 1V, EN1 = EN2 = IN, CIN = 2.2F, COUT = 2.2F, TA = 25°C unless otherwise specified.)

Parameter	Test Conditions	Min	Typ	Max	Unit
Input Supply Range		Note 1		5.5	V
EN Input Voltage		0		VIN	V
Output Voltage Accuracy	IO=1mA	-2.0		+2.0	%
Output Current		150		Note 2	mA
Quiescent Current	IO=0mA		175	250	µA
Shutdown Supply Current	Both outputs disabled		0.1	1	µA
Short Circuit Current	VO= 0V		150		mA
Ground Pin Current	IO=1mA to 150mA		200	250	µA
Line Regulation	IO=50mA VIN = 3.0V to 4.0V VO= 1.8V	-0.15	0.1	0.15	%V
	IO=50mA VIN = 3.5V to 4.5V VO= 2.5				
	IO=50mA VIN = 3.8V to 4.8V VO= 2.8V				
Load Regulation	IO= 1mA to 150mA VIN= 3.3V	-2	1.0	2	%/mA
Power Supply Ripple Rejection	IO=50mA VO = 1.8V		f= 100Hz	70	dB
			f= 1KHz	63	
			f= 10KHz	45	
Dropout Voltage	VO= 1.8V, IO= 150mA		950		mV
	VO= 2.5V, IO= 150mA		350		
	VO= 2.8V, IO= 150mA		180		
Current Limit	VO ≥ 1.2V		200		mA
Output Noise	f= 10Hz to 100KHz		35		µVrms
Over Temperature Hysteresis	IO=1mA		40		°C
Over Temperature Shutdown	IO=1mA		155		°C
EN_ Logic Low Threshold				0.3	V
EN_ Logic High Threshold		1.5			V
EN Pull-up Resistance		1.7	5	15	mΩ
Temperature Coefficient			40		ppm/°C

Note 1: The minimum input voltage of the FSP2150 is determined by output voltage and dropout voltage. The minimum input voltage is defined as:

$$V_{IN(MIN)} = V_O + V_{DROPOUT}$$

Note 2: Output current is limited by PD, maximum IO = PD / (VIN(MAX) - VO)

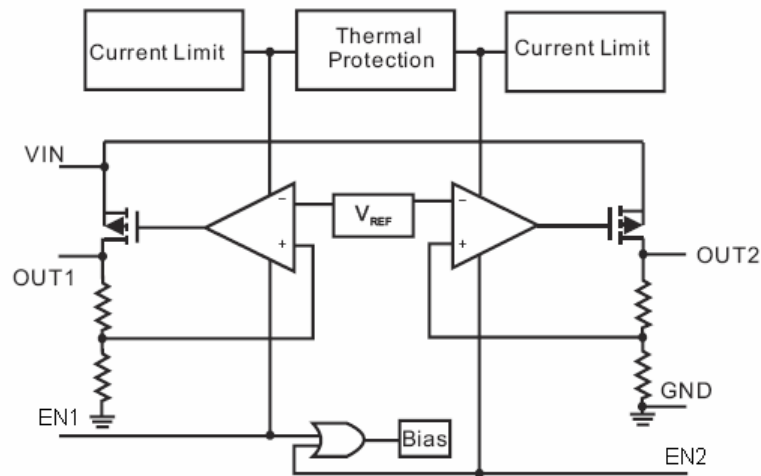
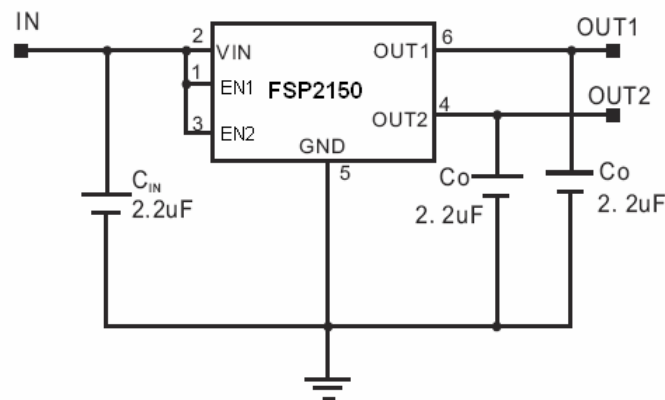
FUNCTIONAL BLOCK DIAGRAM

TYPICAL APPLICATION CIRCUIT

www.DataSheet4U.com

APPLICATION INFORMATION
Capacitor Selection and Regulator Stability

Similar to any low dropout regulator, the external capacitors used with the FSP2150 must be carefully selected for regulator stability and performance.

Using a capacitor, C_{IN} , whose value is $> 2.2 \mu F$ at the FSP2150 input pin, the amount of the capacitance can be increased without limit. Please note that the distance between C_{IN} and the input pin of the FSP2150 should not exceed 0.5 inch. Ceramic capacitors are suitable for the FSP2150. Capacitors with larger values and lower ESR provide better PSRR and line-transient response.

The FSP2150 is designed specifically to work with low ESR ceramic output capacitors in order to save space and improve performance. Using an output ceramic capacitor whose value is $> 2.2 \mu F$ with $ESR > 5m\Omega$ ensure stability.

Shutdown Input Operation

The FSP2150 is shutdown by pulling the EN input low, and is turned on by tying the EN input to VIN or leaving the EN input floating.

Dropout Voltage

A regulator's minimum dropout voltage determines the lowest usable supply voltage. The FSP2150 has a typical 180mV dropout voltage. In battery powered systems, this will determine the useful end-of-life battery voltage.

Current Limit and Short Circuit Protection

The FSP2150 features a current limit, which monitors and controls the gate voltage of the pass transistor. The output current can be limited to 300mA by regulating the gate voltage. The FSP2150 also has a built-in short circuit current limit.

■ TYPICAL PERFORMANCE CHARACTERISTICS

($C_{IN} = 2.2\mu F$, $C_O = 2.2\mu F$, $T_A = 25^\circ C$ unless otherwise specified.)

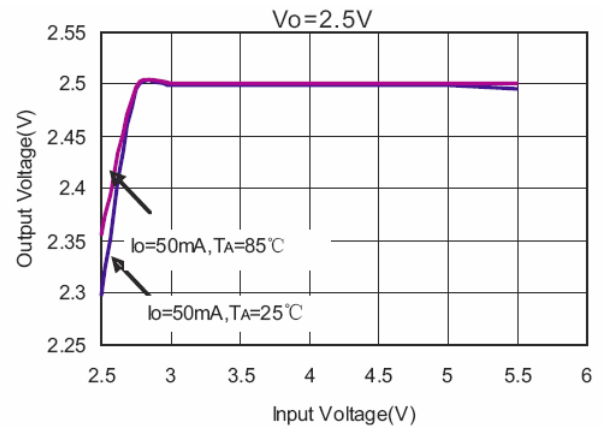
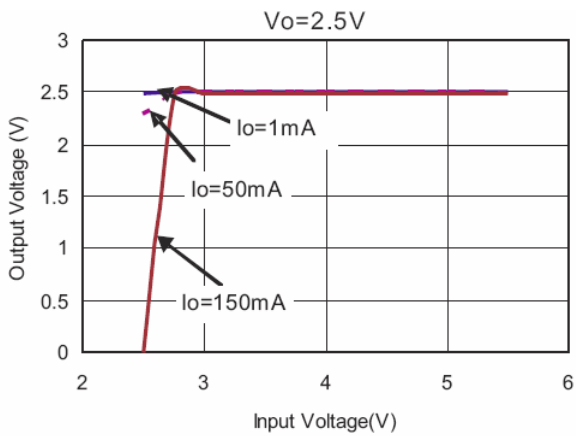
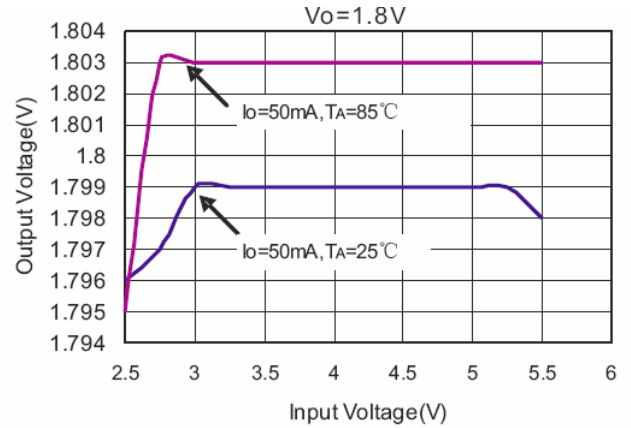
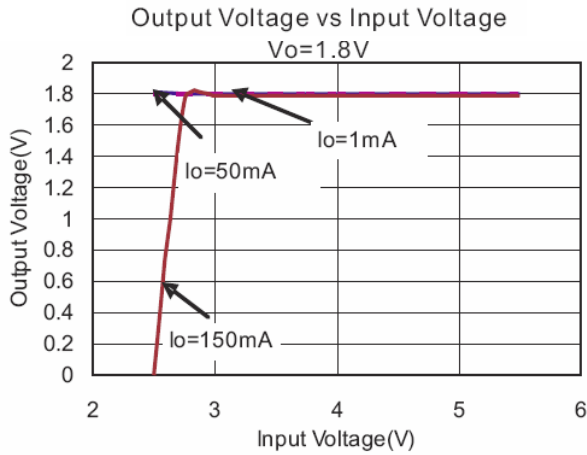

www.DataSheet4U.com

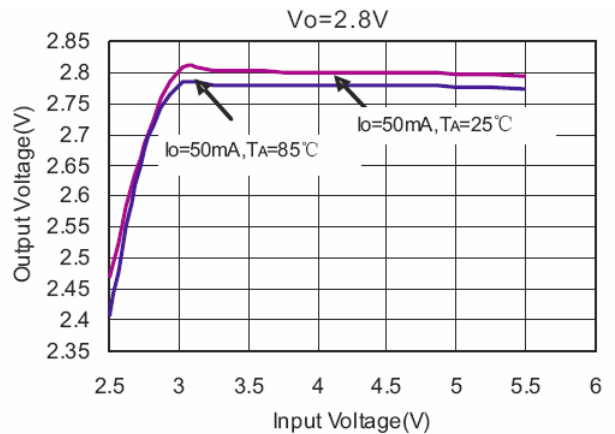
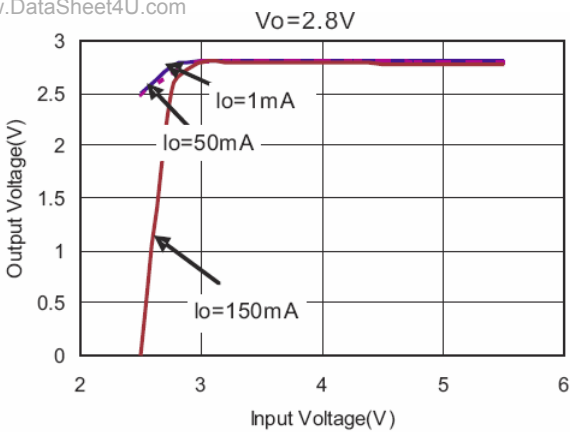



DUAL 150MA HIGH PERFORMANCE MOBILE LDO™ IN SOT23-6L

FSP2150

■ TYPICAL PERFORMANCE CHARACTERISTICS (CONTINUED)

($C_{IN} = 2.2\mu F$, $C_O = 2.2\mu F$, $T_A = 25^\circ C$ unless otherwise specified.)

Output Voltage vs Output Current

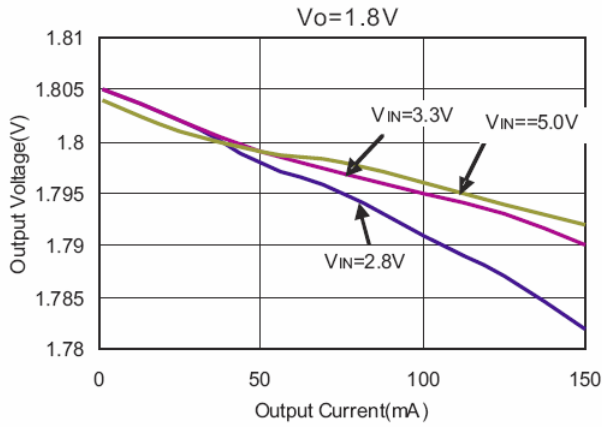

Output Voltage vs Temperature

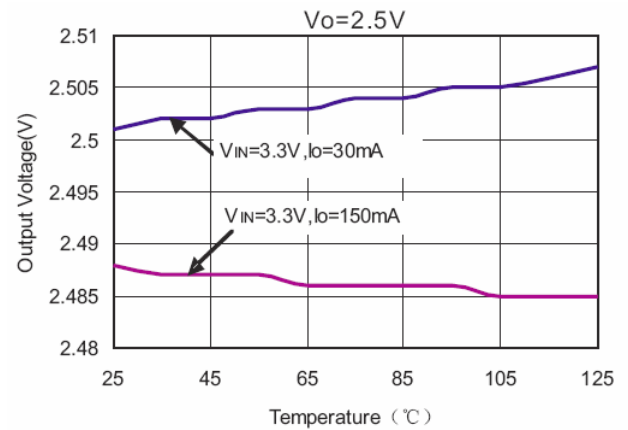
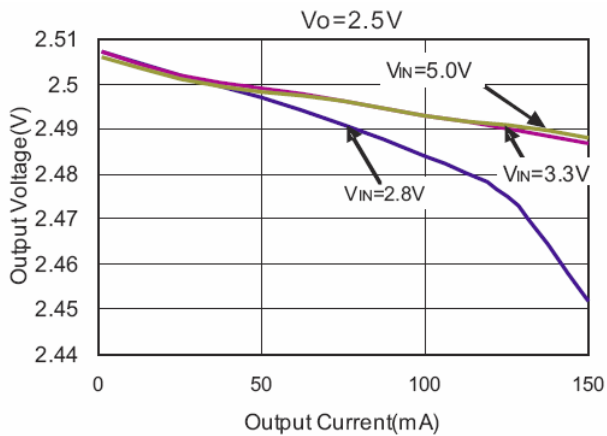
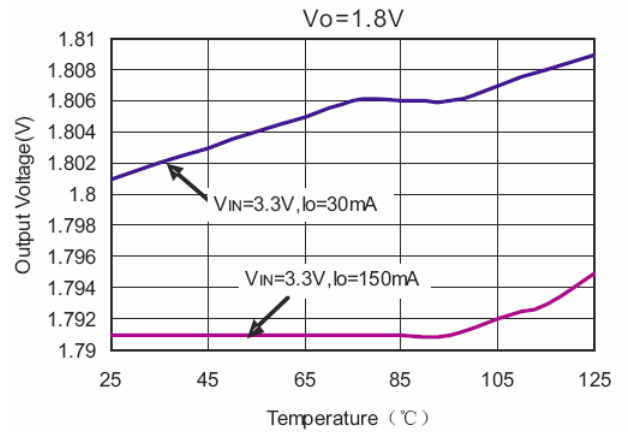

www.DataSheet4U.com

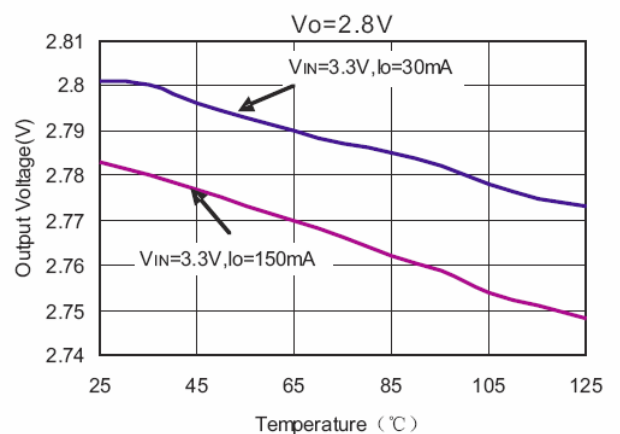
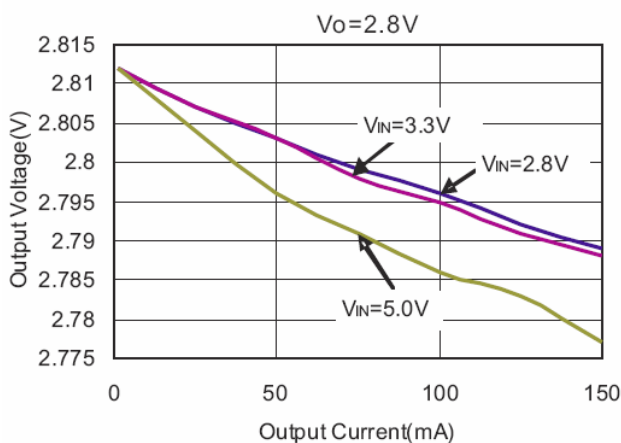

■ TYPICAL PERFORMANCE CHARACTERISTICS (CONTINUED)

($C_{IN} = 2.2\mu F$, $C_O = 2.2\mu F$, $T_A = 25^\circ C$ unless otherwise specified.)

Ground Current vs Input Voltage

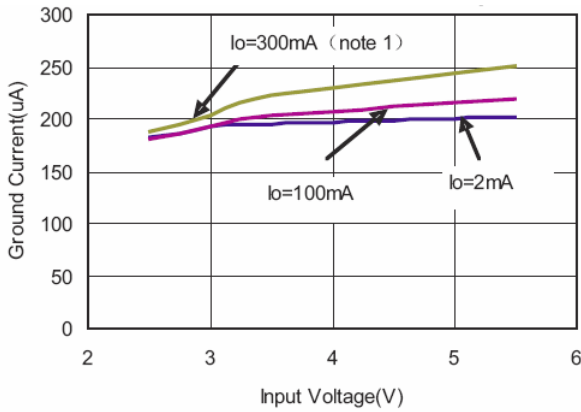

Ground Current vs Output Current

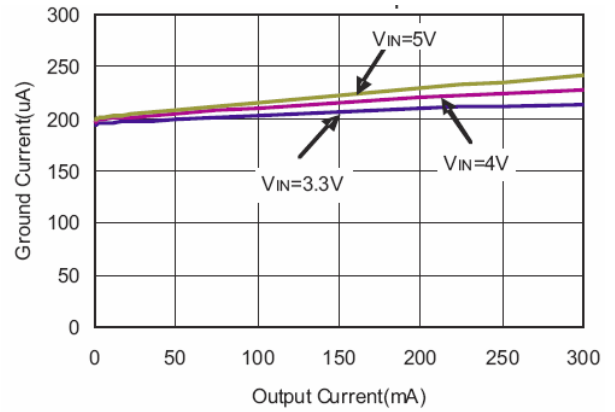

note 1: 2 channels total output current

Quiescent Current vs Input Voltage

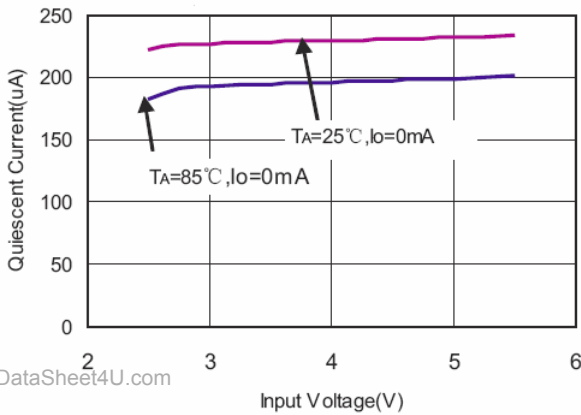

Quiescent Current vs Temperature

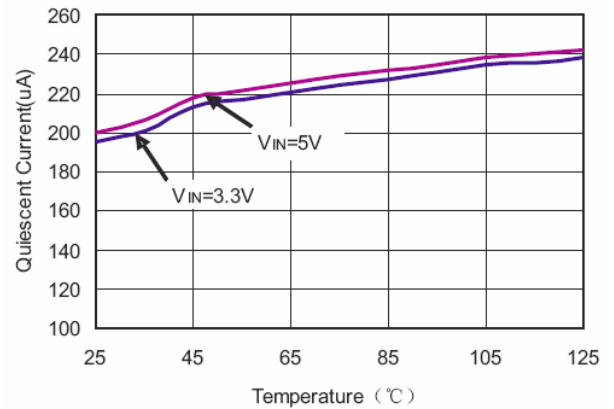

www.DataSheet4U.com

Dropout Voltage vs Output Current

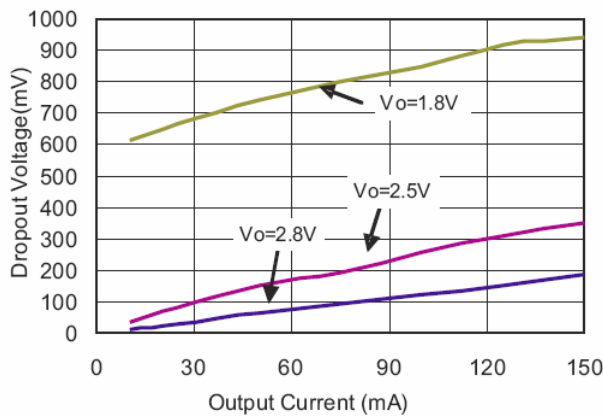

Dropout Voltage vs Temperature

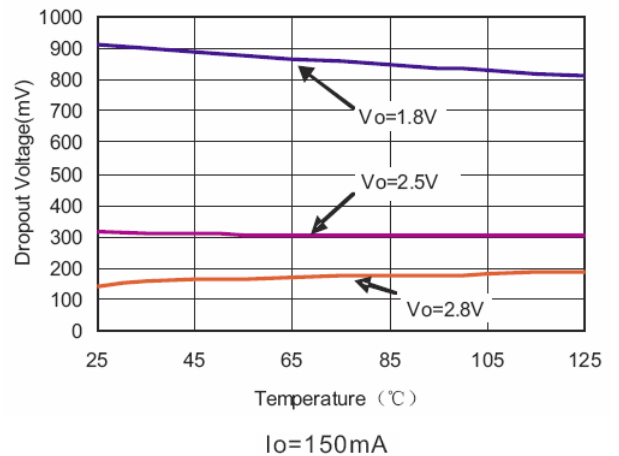

■ TYPICAL PERFORMANCE CHARACTERISTICS (CONTINUED)

($C_{IN} = 2.2\mu F$, $C_O = 2.2\mu F$, $T_A = 25^\circ C$ unless otherwise specified.)

Power Supply Ripple Rejection

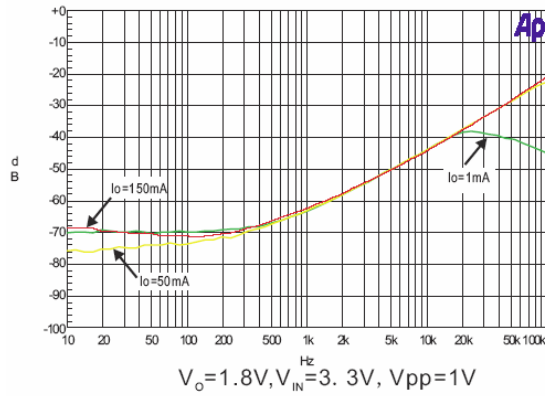

Load Transient Response

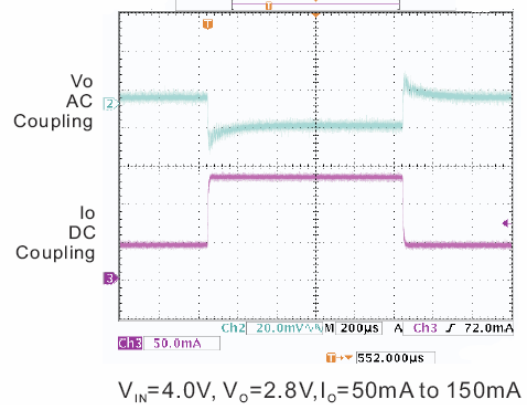
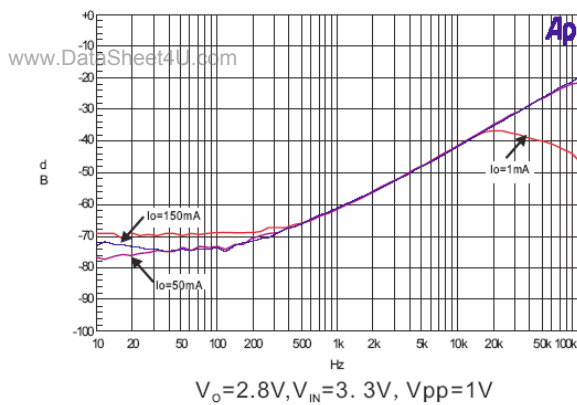
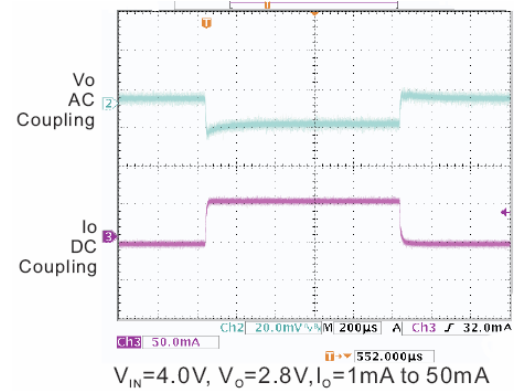
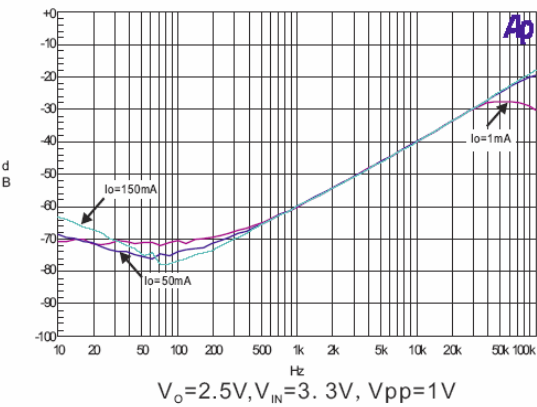
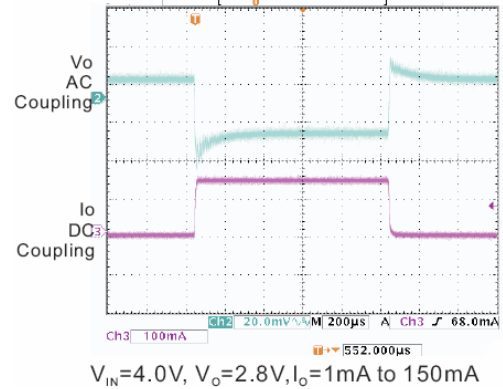



DUAL 150MA HIGH PERFORMANCE MOBILE LDO™ IN SOT23-6L

FSP2150

■ TYPICAL PERFORMANCE CHARACTERISTICS (CONTINUED)

($C_{IN} = 2.2\mu F$, $C_O = 2.2\mu F$, $T_A = 25^\circ C$ unless otherwise specified.)

Line Transient Response

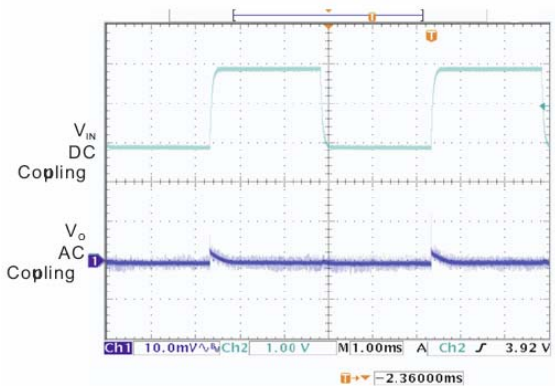

Turn-on Response

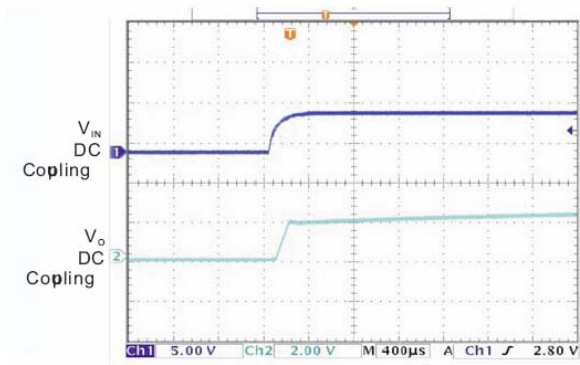

■ ORDERING INFORMATION

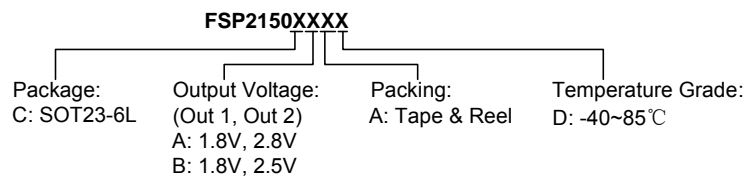

■ MARKING INFORMATION

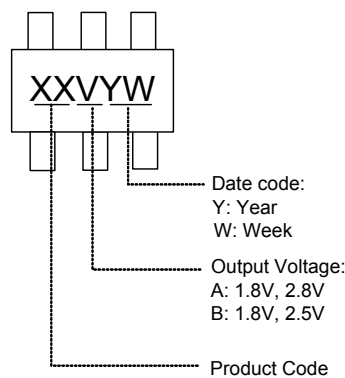

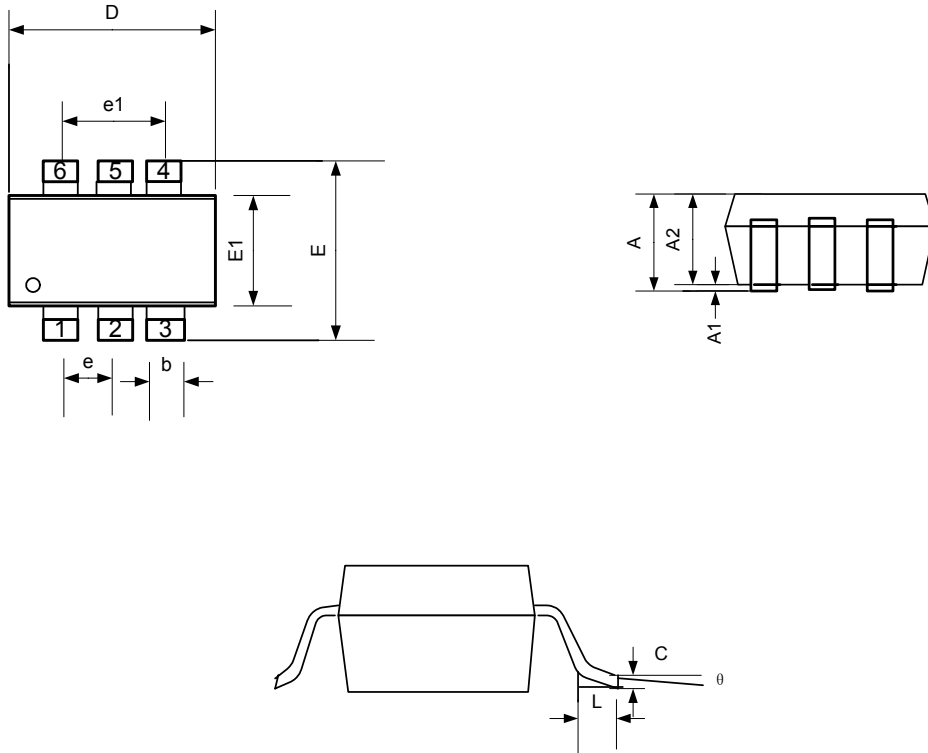
■ PACKAGE INFORMATION

Symbol	Dimensions In Millimeters		Dimensions In Inches	
	Min.	Max.	Min.	Max.
A	1.050	1.250	0.041	0.049
A1	0.000	0.100	0.000	0.004
A2	1.050	1.150	0.041	0.045
b	0.300	0.400	0.012	0.016
C	0.100	0.200	0.004	0.008
D	2.820	3.020	0.111	0.119
E	2.650	2.950	0.104	0.116
E1	1.500	1.700	0.060	0.068
L	0.300	0.600	0.012	0.024
L1	0.700REF		0.028REF	
e1	0.95 Bsc.		0.038 Bsc.	
e	1.90 Bsc.		0.076 Bsc.	
θ	0°	8°	0°	8°