

FSP2151

■ FEATURES

- 180mV Typical Dropout with 150mA Load
- $\pm 2.0\%$ Voltage Accuracy
- High PSRR: 70dB@100Hz
- Low noise output
- Current Limit
- Thermal Shutdown Protection
- Short Circuit Protection
- Very small USP6 Package

■ APPLICATIONS

- Cellular Handsets
- Portable Electronics, PDA
- Wireless Devices, LAN
- Computer Peripherals
- Camera Module
- GPS Receiver

■ PIN CONFIGURATION

■ GENERAL DESCRIPTION

The dual LDO FSP2151 series of positive voltage linear regulators feature high output voltage accuracy, low quiescent current and low dropout voltage, making them ideal for battery powered applications. The line transient response and load transient response are excellent. Their high PSRR make them useful in applications where AC noise on the input power supply must be suppressed. Space-saving USP6 package for 2ch LDOs is attractive for portable and handheld applications. They have both thermal shutdown and a current limit feature to prevent device failure under extreme operating conditions. They are stable with an output capacitance of 2.2 μ F or greater.

(Bottom View)

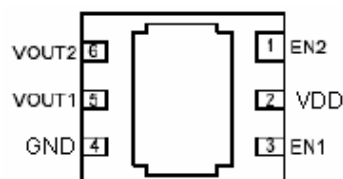

■ PIN DESCRIPTION

Pin Number	Pin Name	Pin Function
1	EN2	Enable pin for LDO2. Connect EN2 to IN or to a logic high for normal operation, drive EN2 to G or a logic low to disable the regulator. Do not leave EN2 floating.
2	VDD	Input Voltage. Bypass this pin with a 1 μ F capacitor connected to G, placed as close to the IC as possible.
3	EN1	Enable pin for LDO1. Connect EN1 to IN or to a logic high for normal operation, drive EN1 to G or a logic low to disable the regulator. Do not leave EN1 floating.
4	GND	Ground.
5	VOUT1	LDO1 Output. Bypass this pin with a 1 μ F capacitor connected to G. OUT1 is actively discharged to G through 800 Ω when disabled.
6	VOUT2	LDO2 Output. Bypass this pin with a 1 μ F capacitor connect to G. OUT2 is actively discharged to G through 800 Ω when disabled.

■ ABSOLUTE MAXIMUM RATINGS

Parameter	Rating	Unit
Input Voltage	6	V
Output Pin Voltage	GND-0.3 to VIN + 0.3	V
Output Current	150/150	mA
Internal Power Dissipation)	100	mW
ESD Rating(HBM)	2000	V
Operating Junction Temperature	-40 to 125	°C
Operating Ambient Temperature	-40 to 85	°C
Storage Temperature	-40 to 125	°C
Lead Temperature (Soldering, 5 sec)	300	°C

Note: Absolute Maximum Ratings are those values beyond which the life of a device may be impaired

■ ELECTRICAL CHARACTERISTICS

(VIN = VOUT + 1V, EN1 = EN2 = IN, CIN = 2.2F, COUT = 2.2F, TA = 25°C unless otherwise specified.)

Parameter	Test Conditions	Min	Typ	Max	Unit
Input Supply Range		Note 1		5.5	V
EN Input Voltage		0		VIN	V
Output Voltage Accuracy	IO=1mA	-2.0		+2.0	%
Output Current		150		Note 2	mA
Quiescent Current	IO=0mA		175	250	µA
Shutdown Supply Current	Both outputs disabled		0.1	1	µA
Short Circuit Current	VO= 0V		150		mA
Ground Pin Current	IO=0mA to 150mA		200	250	µA
Line Regulation	IO=50mA VIN = 3.0V to 4.0V VO= 1.8V	-0.15	0.1	0.15	%V
	IO=50mA VIN = 3.5V to 4.5V VO= 2.5				
	IO=50mA VIN = 3.8V to 4.8V VO= 2.8V				
Load Regulation	IO= 1mA to 150mA VIN= 3.3V	-2	1.0	2	%/mA
Power Supply Ripple Rejection	IO=50mA VO = 1.8V		f= 100Hz	70	dB
			f= 1KHz	63	
			f= 10KHz	45	
Dropout Voltage	VO= 1.8V, IO= 150mA		950		mV
	VO= 2.5V, IO= 150mA		350		
	VO= 2.8V, IO= 150mA		180		
Current Limit	VO ≥ 1.2V		200		mA
Output Noise	f= 10Hz to 100KHz		35		µVrms
Over Temperature Hysteresis	IO=1mA		40		°C
Over Temperature Shutdown	IO=1mA		155		°C
EN_ Logic Low Threshold				0.3	V
EN_ Logic High Threshold		1.5			V
EN Pull-up Resistance		1.7	5	15	mΩ
Temperature Coefficient			40		ppm/°C

Note 1: The minimum input voltage of the FSP2151 is determined by output voltage and dropout voltage. The minimum input voltage is defined as:

$$V_{IN(MIN)} = V_O + V_{DROPOUT}$$

Note 2: Output current is limited by PD, maximum IO = PD / (VIN(MAX) - VO)

FUNCTIONAL BLOCK DIAGRAM

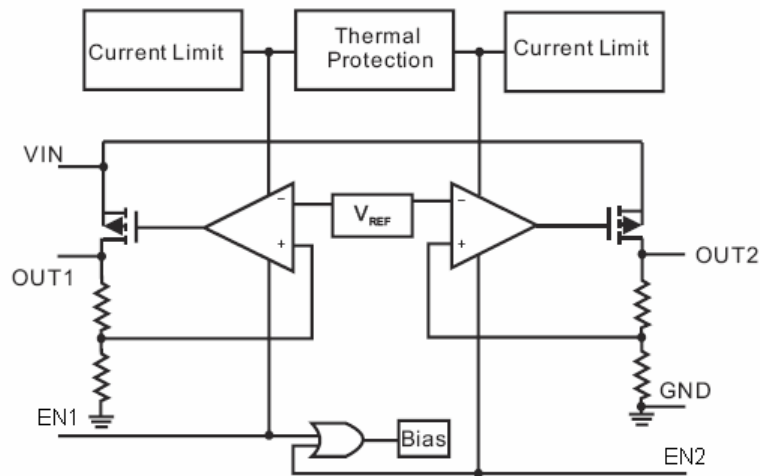

TYPICAL APPLICATION CIRCUIT

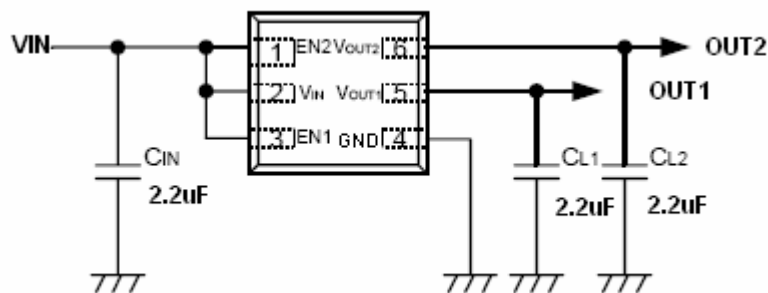

www.DataSheet4U.com

APPLICATION INFORMATION

Capacitor Selection and Regulator Stability

Similar to any low dropout regulator, the external capacitors used with the FSP2151 must be carefully selected for regulator stability and performance.

Using a capacitor, C_{IN} , whose value is $> 2.2 \mu F$ at the FSP2151 input pin, the amount of the capacitance can be increased without limit. Please note that the distance between C_{IN} and the input pin of the FSP2151 should not exceed 0.5 inch. Ceramic capacitors are suitable for the FSP2151. Capacitors with larger values and lower ESR provide better PSRR and line-transient response.

The FSP2151 is designed specifically to work with low ESR ceramic output capacitors in order to save space and improve performance. Using an output ceramic capacitor whose value is $> 2.2 \mu F$ with $ESR > 5m\Omega$ ensure stability.

Shutdown Input Operation

The FSP2151 is shutdown by pulling the EN input low, and is turned on by tying the EN input to VIN or leaving the EN input floating.

Dropout Voltage

A regulator's minimum dropout voltage determines the lowest usable supply voltage. The FSP2151 has a typical 180mV dropout voltage. In battery powered systems, this will determine the useful end-of-life battery voltage.

Current Limit and Short Circuit Protection

The FSP2151 features a current limit, which monitors and controls the gate voltage of the pass transistor. The output current can be limited to 300mA by regulating the gate voltage. The FSP2151 also has a built-in short circuit current limit.

■ TYPICAL PERFORMANCE CHARACTERISTICS

($C_{IN} = 2.2\mu F$, $C_O = 2.2\mu F$, $T_A = 25^\circ C$ unless otherwise specified.)

Output Voltage vs Input Voltage

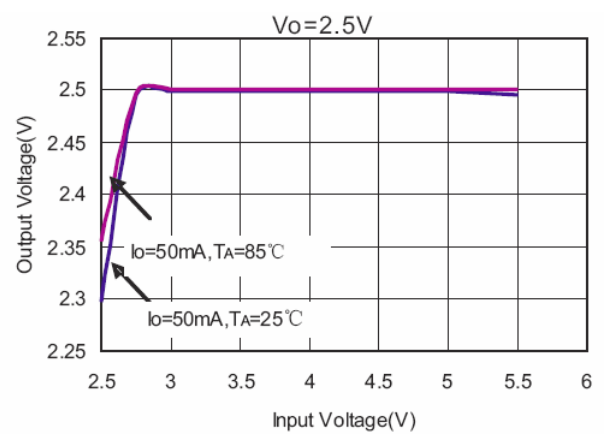
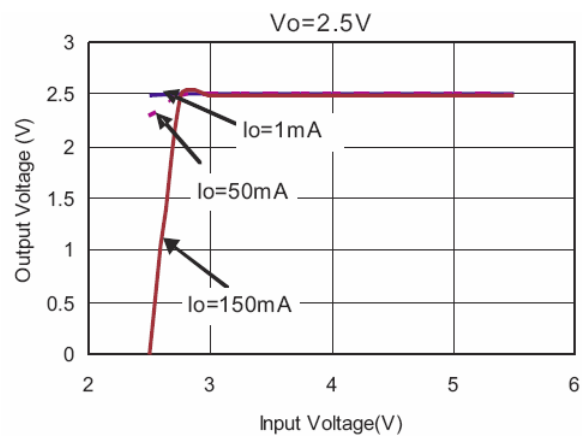
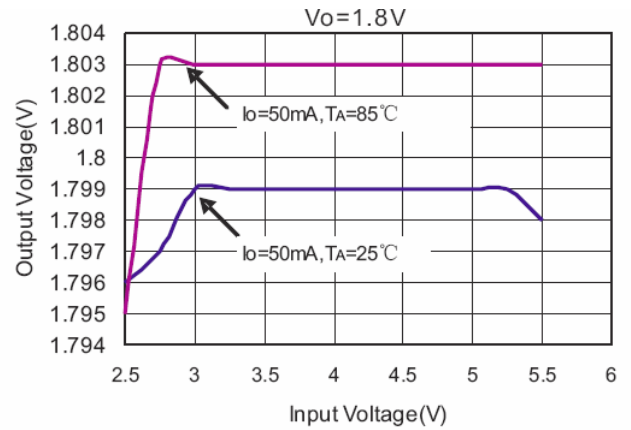
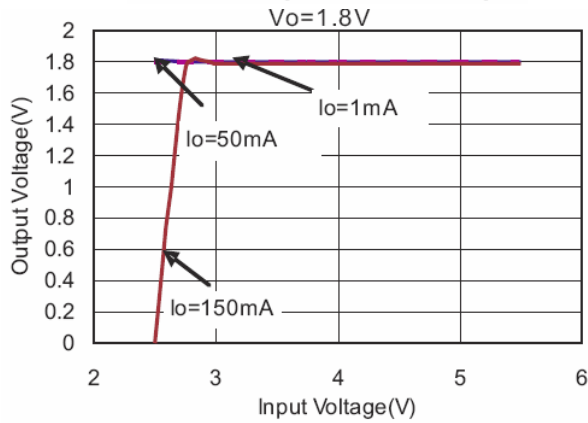

www.DataSheet4U.com

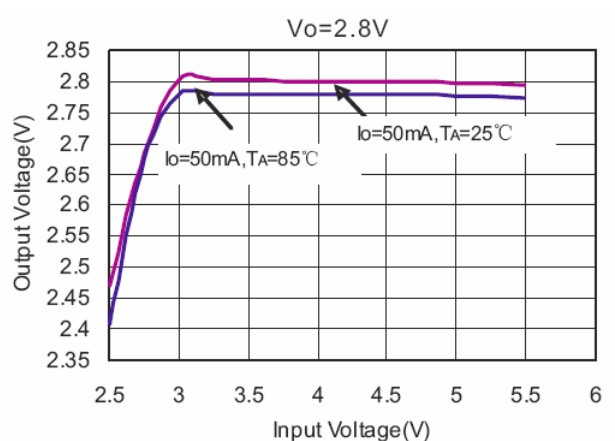
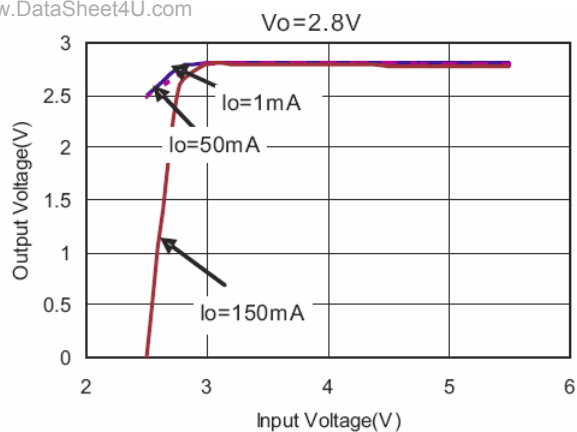



DUAL 150MA HIGH PERFORMANCE MOBILE LDO™ IN USP6

FSP2151

■ TYPICAL PERFORMANCE CHARACTERISTICS (CONTINUED)

($C_{IN} = 2.2\mu F$, $C_O = 2.2\mu F$, $T_A = 25^\circ C$ unless otherwise specified.)

Output Voltage vs Output Current

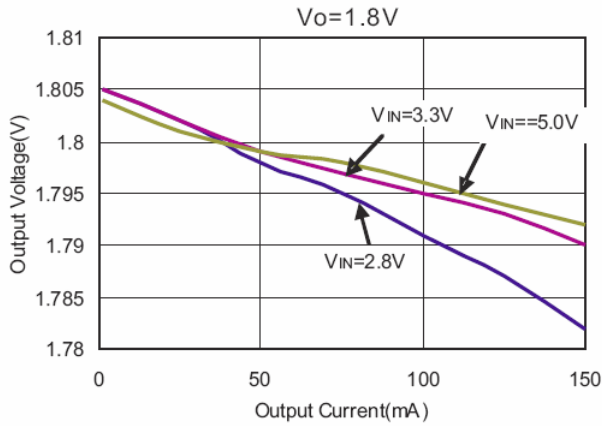

Output Voltage vs Temperature

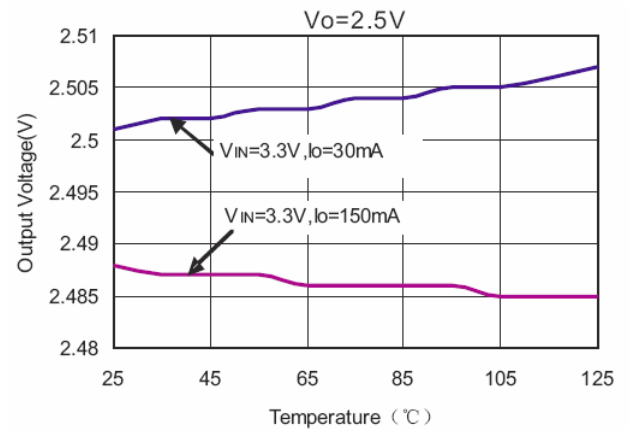
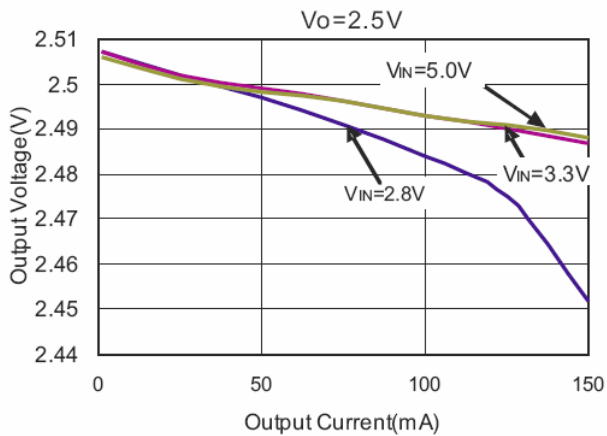
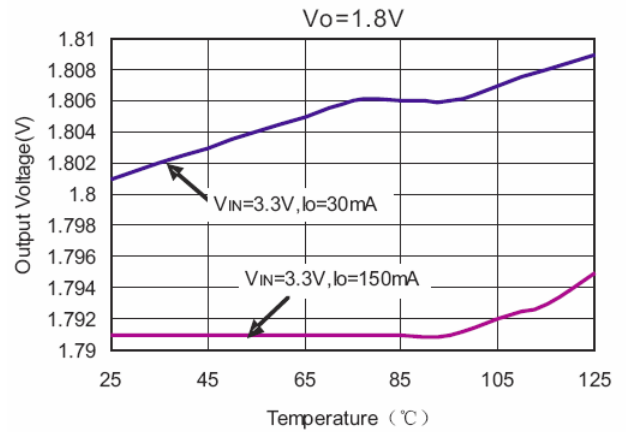

www.DataSheet4U.com

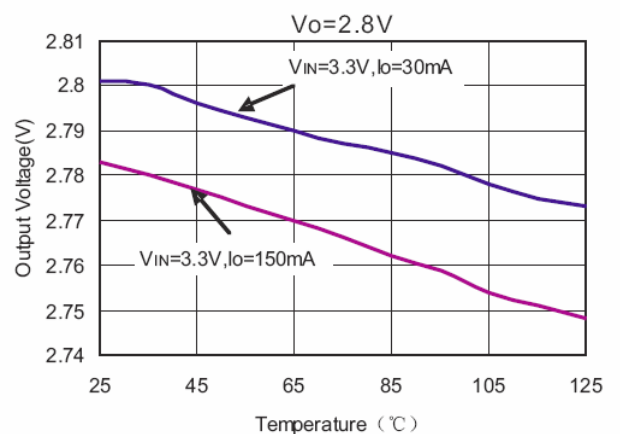
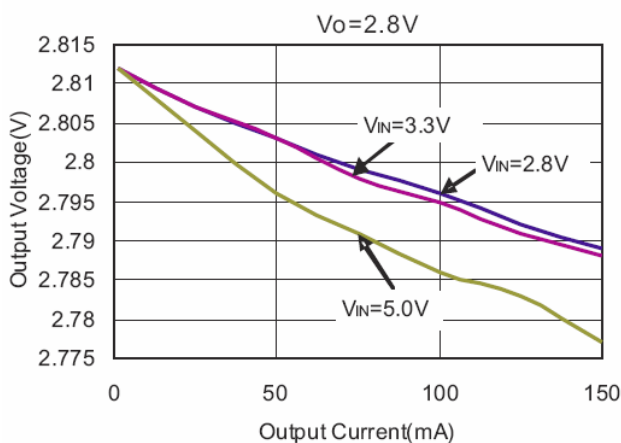



DUAL 150MA HIGH PERFORMANCE MOBILE LDO™ IN USP6

FSP2151

■ TYPICAL PERFORMANCE CHARACTERISTICS (CONTINUED)

($C_{IN} = 2.2\mu F$, $C_O = 2.2\mu F$, $T_A = 25^\circ C$ unless otherwise specified.)

Ground Current vs Input Voltage

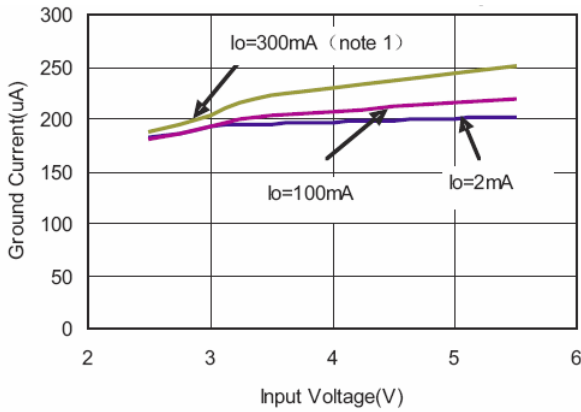

Ground Current vs Output Current

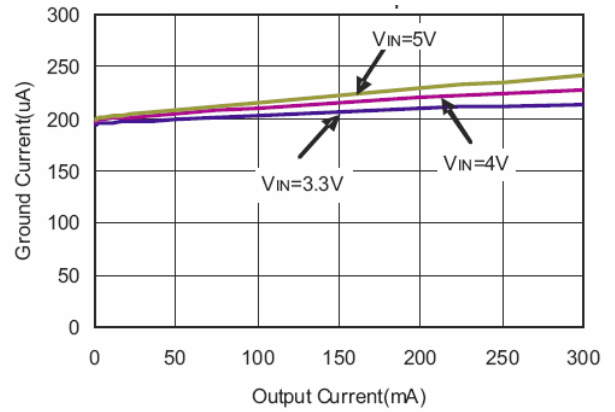

note 1: 2 channels total output current

Quiescent Current vs Input Voltage

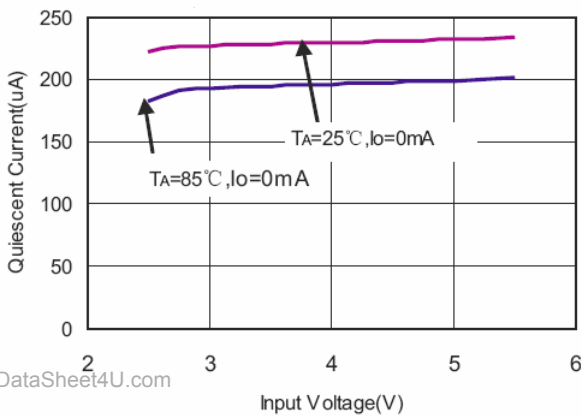

Quiescent Current vs Temperature

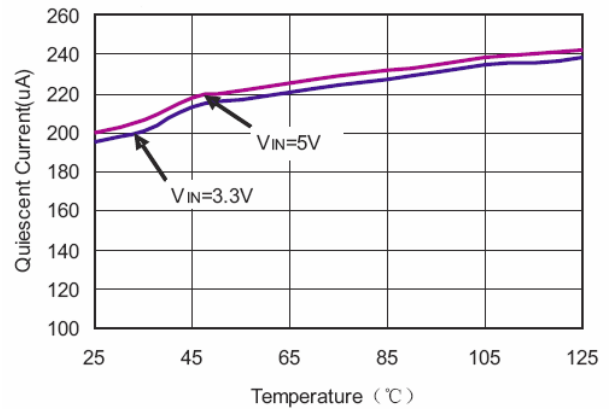

www.DataSheet4U.com

Dropout Voltage vs Output Current

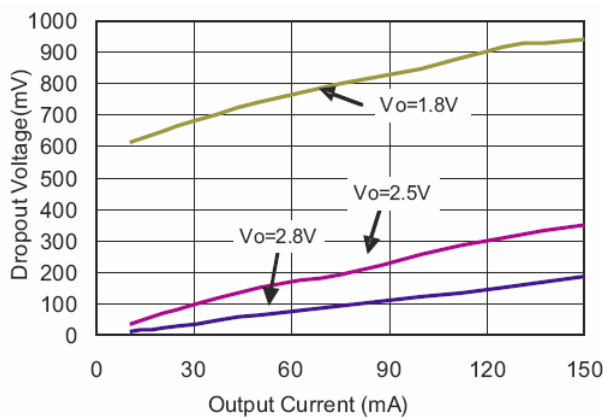

Dropout Voltage vs Temperature

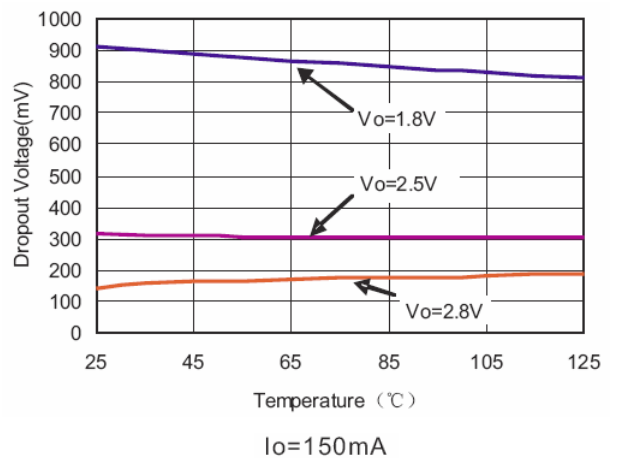

■ **TYPICAL PERFORMANCE CHARACTERISTICS (CONTINUED)**

($C_{IN} = 2.2\mu F$, $C_O = 2.2\mu F$, $T_A = 25^\circ C$ unless otherwise specified.)

Power Supply Ripple Rejection

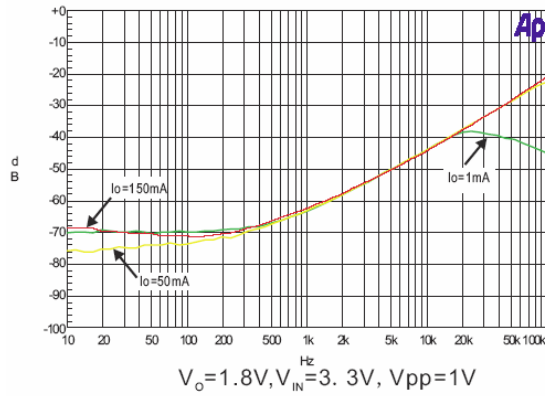

Load Transient Response

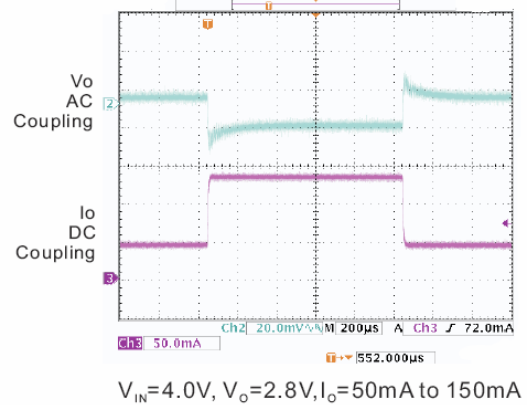
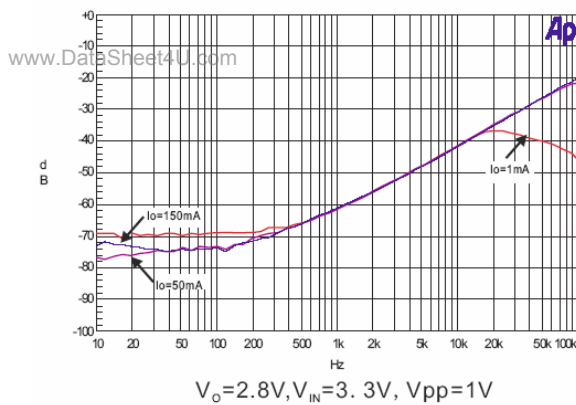
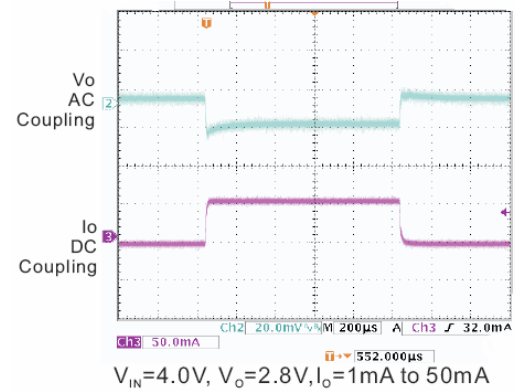
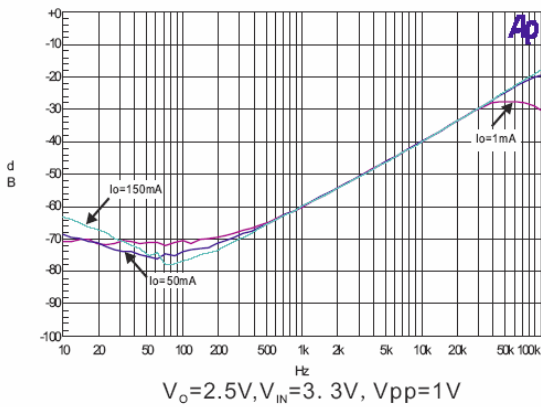
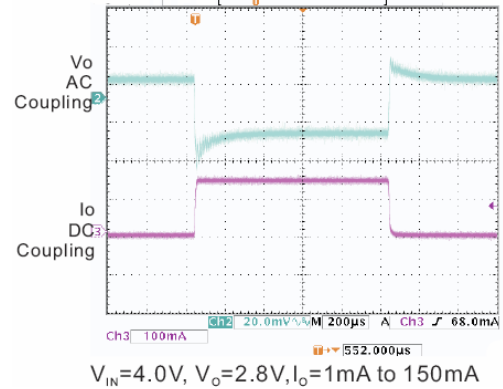



DUAL 150MA HIGH PERFORMANCE MOBILE LDO™ IN USP6

FSP2151

■ TYPICAL PERFORMANCE CHARACTERISTICS (CONTINUED)

($C_{IN} = 2.2\mu F$, $C_O = 2.2\mu F$, $T_A = 25^\circ C$ unless otherwise specified.)

Line Transient Response

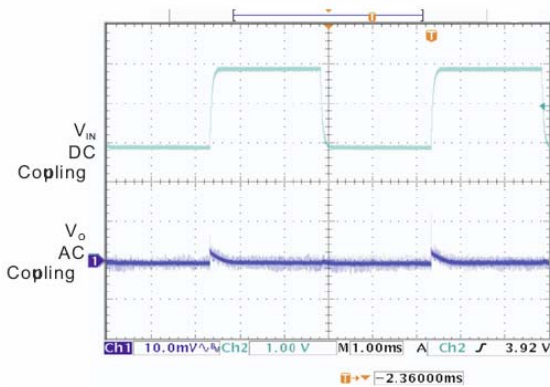

Turn-on Response

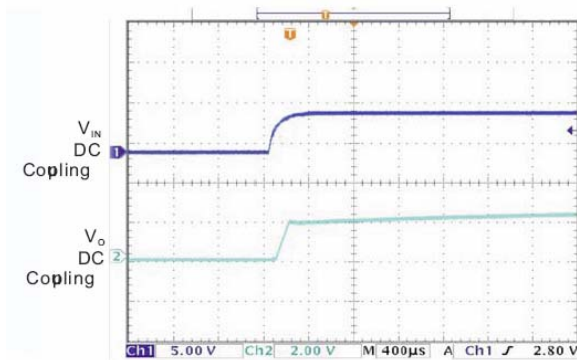

■ ORDERING INFORMATION

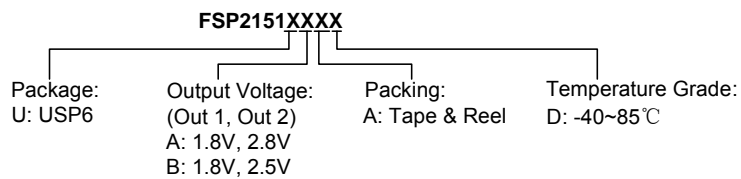

■ MARKING INFORMATION

www.DataSheet4U.com

