

## FSTU16245 16-Bit Bus Switch with -2V Undershoot Protection

### General Description

The Fairchild Switch FSTU16245 provides 16-bits of high-speed CMOS TTL-compatible bus switching. The low On Resistance of the switch allows inputs to be connected to outputs without adding propagation delay or generating additional ground bounce noise.

The device is organized as a 16-bit switch. There are two 8-bit switches with separate output enable inputs. When  $\overline{OE}$  is LOW, the switch is ON and Port a is connected to Port B. When  $\overline{OE}$  is HIGH, the switch is OFF and a high impedance state exists between the A and B Ports. The A and B Ports are protected against undershoot to support an extended range to 2.0V below ground. Fairchild's integrated Undershoot Hardened Circuit (UHC™) senses undershoot at the I/O and responds by preventing voltage differentials from developing and turning the switch on. When  $\overline{OE}$  is HIGH, the switch is OPEN and a high-impedance state exists between the two ports.

### Features

- Undershoot hardened to -2V (A and B Ports)
- 4Ω switch connection between two ports.
- Minimal propagation delay through the switch.
- Low  $I_{CC}$ .
- Zero bounce in flow-through mode.
- Control inputs compatible with TTL level.
- See Application Note AN-5008 for details

### Ordering Code:

| Order Number | Package Number | Package Description   |
|--------------|----------------|---|
| FSTU16245MTD | MTD48          | 48-Lead Thin Shrink Small Outline Package (TSSOP), JEDEC MO-153, 6.1mm Wide |

Devices also available in Tape and Reel. Specify by appending the suffix letter "X" to the ordering code.

### Connection Diagram

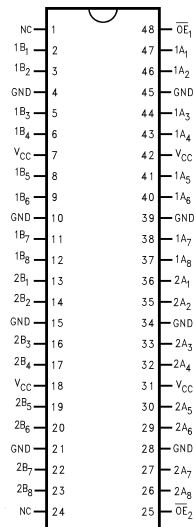

### Pin Descriptions

| Pin Name  | Description                      |
|---|----------------------------------|
| $\overline{OE}_n$   | Output Enable Input (Active LOW) |
| 1A <sub>n</sub> , 2A <sub>n</sub> , 3A <sub>n</sub> , 4A <sub>n</sub> | Bus A                            |
| 1B <sub>n</sub> , 2B <sub>n</sub> , 3B <sub>n</sub> , 4B <sub>n</sub> | Bus B                            |
| NC  | No Internal Connection           |

UHC™ is a trademark of Fairchild Semiconductor Corporation.

FSTU16245 16-Bit Bus Switch with -2V Undershoot Protection

**Logic Diagram**

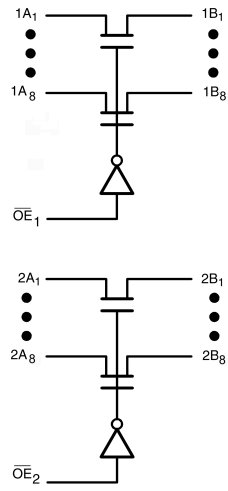

**Truth Table**

| Inputs            | Outputs         |
|-------------------|-----------------|
| $\overline{OE_x}$ | A, B            |
| L                 | A Port = B Port |
| H                 | Z               |

H = HIGH Voltage Level  
 L = LOW Voltage Level  
 Z = High Impedance

**Absolute Maximum Ratings**(Note 1)

|   |                  |
|---|------------------|
| Supply Voltage ( $V_{CC}$ )                       | -0.5V to +7.0V   |
| DC Switch Voltage ( $V_S$ ) (Note 2)              | -2.0V to +7.0V   |
| DC Input Voltage ( $V_{IN}$ ) (Note 3)            | -0.5V to +7.0V   |
| DC Input Diode Current ( $I_{IK}$ ) $V_{IN} < 0V$ | -50mA            |
| DC Output Current ( $I_{OUT}$ )                   | 128mA            |
| DC $V_{CC}/GND$ Current ( $I_{CC}/I_{GND}$ )      | $\pm 100mA$      |
| Storage Temperature Range ( $T_{STG}$ )           | -65°C to +150 °C |

**Recommended Operating Conditions** (Note 4)

|  |                  |
|--|------------------|
| Power Supply Operating ( $V_{CC}$ )      | 4.0V to 5.5V     |
| Input Voltage ( $V_{IN}$ )               | 0V to 5.5V       |
| Output Voltage ( $V_{OUT}$ )             | 0V to 5.5V       |
| Input Rise and Fall Time ( $t_r, t_f$ )  |                  |
| Switch Control Input                     | 0nS/V to 5nS/V   |
| Switch I/O                               | 0nS/V to DC      |
| Free Air Operating Temperature ( $T_A$ ) | -40 °C to +85 °C |

**Note 1:** The "Absolute Maximum Ratings" are those values beyond which the safety of the device cannot be guaranteed. The device should not be operated at these limits. The parametric values defined in the Electrical Characteristics tables are not guaranteed at the absolute maximum rating. The "Recommended Operating Conditions" table will define the conditions for actual device operation.

**Note 2:**  $V_S$  is the voltage observed/applied at either the A or B Ports across the switch.

**Note 3:** The input and output negative voltage ratings may be exceeded if the input and output diode current ratings are observed.

**Note 4:** Unused control inputs must be held HIGH or LOW. They may not float.

**DC Electrical Characteristics**

| Symbol          | Parameter                        | $V_{CC}$<br>(V) | Min | Typ<br>(Note 5) | Max       | Units    | Conditions   |
|-----------------|----------------------------------|-----------------|-----|-----------------|-----------|----------|--|
| $V_{IK}$        | Clamp Diode Voltage              | 4.5             |     |                 | -1.2      | V        | $I_{IN} = -18mA$   |
| $V_{IH}$        | HIGH Level Input Voltage         | 4.0-5.5         | 2.0 |                 |           | V        |  |
| $V_{IL}$        | LOW Level Input Voltage          | 4.0-5.5         |     |                 | 0.8       | V        |  |
| $I_I$           | Input Leakage Current            | 5.5             |     |                 | $\pm 1.0$ | $\mu A$  | $0 \leq V_{IN} \leq 5.5V$                                  |
|                 |                                  | 0               |     |                 | 10        | $\mu A$  | $V_{IN} = 5.5V$  |
| $I_{OZ}$        | OFF-STATE Leakage Current        | 5.5             |     |                 | $\pm 1.0$ | $\mu A$  | $0 \leq A, B \leq V_{CC}$                                  |
| $R_{ON}$        | Switch On Resistance<br>(Note 6) | 4.5             |     | 4               | 7         | $\Omega$ | $V_{IN} = 0V, I_{IN} = 64 mA$                              |
|                 |                                  | 4.5             |     | 4               | 7         | $\Omega$ | $V_{IN} = 0V, I_{IN} = 30 mA$                              |
|                 |                                  | 4.5             |     | 8               | 14        | $\Omega$ | $V_{IN} = 2.4V, I_{IN} = 15 mA$                            |
|                 |                                  | 4.0             |     | 11              | 20        | $\Omega$ | $V_{IN} = 2.4V, I_{IN} = 15 mA$                            |
| $I_{CC}$        | Quiescent Supply Current         | 5.5             |     |                 | 3         | $\mu A$  | $V_{IN} = V_{CC}$ or GND, $I_{OUT} = 0$                    |
| $\Delta I_{CC}$ | Increase in $I_{CC}$ per Input   | 5.5             |     |                 | 2.5       | mA       | One input at 3.4V<br>Other inputs at $V_{CC}$ or GND       |
| $V_{IKU}$       | Voltage Undershoot               | 5.5             |     |                 | -2.0      | V        | $0.0 mA \geq I_{IN} \geq -50 mA$<br>$\overline{OE} = 5.5V$ |

**Note 5:** Typical values are at  $V_{CC} = 5.0V$  and  $T_A = +25^\circ C$

**Note 6:** Measured by the voltage drop between A and B pins at the indicated current through the switch. On Resistance is determined by the lower of the voltages on the two (A or B) pins.

## AC Electrical Characteristics

| Symbol             | Parameter                      | $T_A = -40\text{ }^\circ\text{C to }+85\text{ }^\circ\text{C}$<br>$C_L = 50\text{pF, } R_U = R_D = 500\Omega$ |      |                        |      | Units | Conditions   | Figure Number |
|--------------------|--------------------------------|---|------|------------------------|------|-------|--|---------------|
|                    |                                | $V_{CC} = 4.5 - 5.5\text{V}$  |      | $V_{CC} = 4.0\text{V}$ |      |       |  |               |
|                    |                                | Min   | Max  | Min                    | Max  |       |  |               |
| $t_{PHL}, t_{PLH}$ | Prop Delay Bus-to-Bus (Note 7) |   | 0.25 |                        | 0.25 | ns    | $V_I = \text{OPEN}$  | Figures 2, 3  |
| $t_{PZH}, t_{PZL}$ | Output Enable Time             | 1.0   | 6.5  |                        | 6.9  | ns    | $V_I = 7\text{V}$ for $t_{PZL}$<br>$V_I = \text{OPEN}$ for $t_{PZH}$ | Figures 2, 3  |
| $t_{PHZ}, t_{PLZ}$ | Output Disable Time            | 1.0   | 6.1  |                        | 6.5  | ns    | $V_I = 7\text{V}$ for $t_{PLZ}$<br>$V_I = \text{OPEN}$ for $t_{PHZ}$ | Figures 2, 3  |

**Note 7:** This parameter is guaranteed by design but is not tested. The bus switch contributes no propagation delay other than the RC delay of the typical On Resistance of the switch and the 50pF load capacitance, when driven by an ideal voltage source (zero output impedance).

## Capacitance (Note 8)

| Symbol    | Parameter                            | Typ | Max | Units | Conditions   |
|-----------|--------------------------------------|-----|-----|-------|--|
| $C_{IN}$  | Control Pin Input Capacitance        | 3   |     | pF    | $V_{CC} = 5.0\text{V, } V_{IN} = 0\text{V}$                |
| $C_{I/O}$ | Input/Output Capacitance "OFF State" | 6   |     | pF    | $V_{CC}, \overline{OE} = 5.0\text{V, } V_{IN} = 0\text{V}$ |

**Note 8:**  $T_A = +25\text{ }^\circ\text{C}$ ,  $f = 1\text{ MHz}$ , Capacitance is characterized but not tested.

## Undershoot Characteristic (Note 9)

| Symbol     | Parameter                        | Min | Typ            | Max | Units | Conditions |
|------------|----------------------------------|-----|----------------|-----|-------|------------|
| $V_{OUTU}$ | Output Voltage During Undershoot | 2.5 | $V_{OH} - 0.3$ |     | V     | Figure 1   |

**Note 9:** This test is intended to characterize the device's protective capabilities by maintaining output signal integrity during an input transient voltage undershoot event.

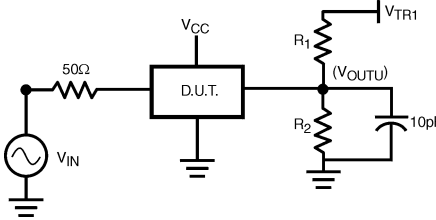
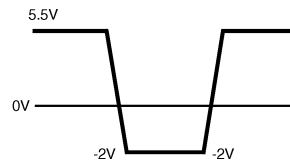

FIGURE 1.

## Device Test Conditions

| Parameter   | Value        | Units    |
|-------------|--------------|----------|
| $V_{IN}$    | see Waveform | V        |
| $R_1 = R_2$ | 100K         | $\Omega$ |
| $V_{TR1}$   | 11.0         | V        |
| $V_{CC}$    | 5.5          | V        |

## Transient Input Voltage ( $V_{IN}$ ) Waveform



## AC Loading and Waveforms

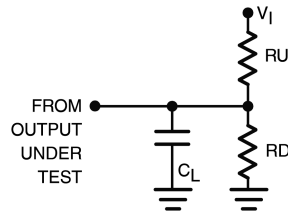

**Note:** Input driven by 50Ω source terminated in 50Ω

**Note:**  $C_L$  includes load and stray capacitance

**Note:** Input PRR = 1.0 MHz,  $t_W = 500$  ns

FIGURE 2. AC Test Circuit

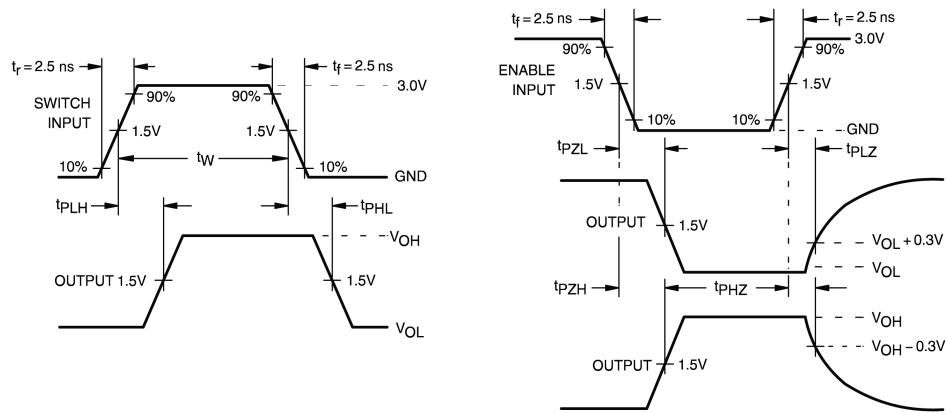
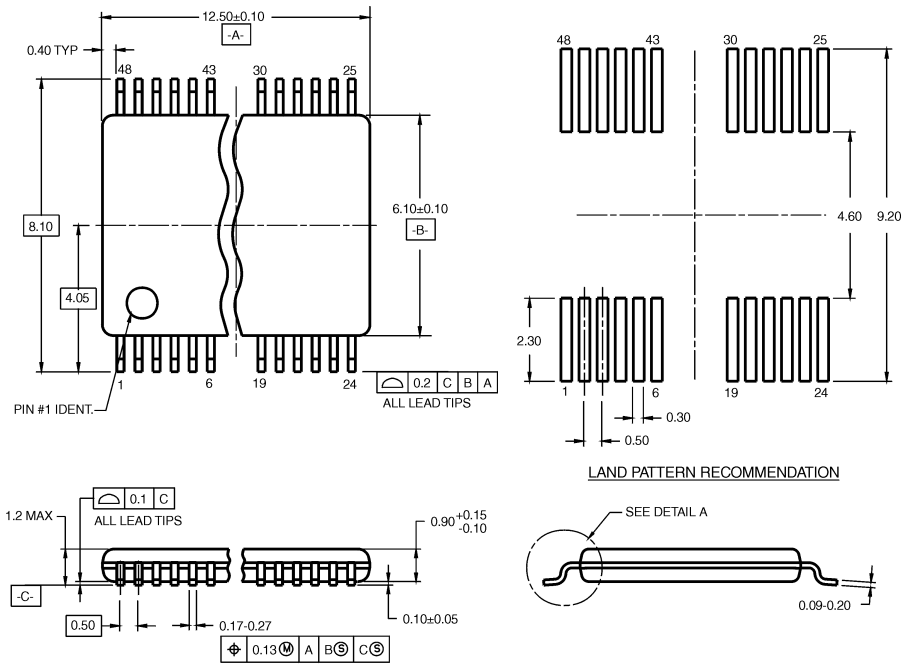

FIGURE 3. AC Waveforms

**Physical Dimensions** inches (millimeters) unless otherwise noted



DIMENSIONS ARE IN MILLIMETERS

**NOTES:**

- A. CONFORMS TO JEDEC REGISTRATION MO-153, VARIATION AB, REF NOTE 6, DATE 7/93.
- B. DIMENSIONS ARE IN MILLIMETERS.
- C. DIMENSIONS ARE EXCLUSIVE OF BURRS, MOLD FLASH, AND THE BAR EXTRUSIONS.
- D. DIMENSIONS AND TOLERANCES PER ANSI Y14.5M, 1982.

MTD48RevB1

**48-Lead Thin Shrink Small Outline Package (TSSOP), JEDEC MO-153, 6.1mm Wide Package Number MTD48**

**Technology Description**

The Fairchild Switch family derives from and embodies Fairchild's proven switch technology used for several years in its 74LVX3L384(FST3384) bus switch product.

Fairchild does not assume any responsibility for use of any circuitry described, no circuit patent licenses are implied and Fairchild reserves the right at any time without notice to change said circuitry and specifications.

**LIFE SUPPORT POLICY**

FAIRCHILD'S PRODUCTS ARE NOT AUTHORIZED FOR USE AS CRITICAL COMPONENTS IN LIFE SUPPORT DEVICES OR SYSTEMS WITHOUT THE EXPRESS WRITTEN APPROVAL OF THE PRESIDENT OF FAIRCHILD SEMICONDUCTOR CORPORATION. As used herein:

1. Life support devices or systems are devices or systems which, (a) are intended for surgical implant into the body, or (b) support or sustain life, and (c) whose failure to perform when properly used in accordance with instructions for use provided in the labeling, can be reasonably expected to result in a significant injury to the user.
2. A critical component in any component of a life support device or system whose failure to perform can be reasonably expected to cause the failure of the life support device or system, or to affect its safety or effectiveness.

[www.fairchildsemi.com](http://www.fairchildsemi.com)