

HF 200W ALL MODE TRANSCEIVER

# MARK-V FT-1000MP



www.DataSheet4U.com

# Building on the tremendous success of the FT-1000D and FT-1000MP Elite-Class HF Transceivers, the MARK-V brings five exciting new developments in amateur radio technology.

## I. 200 WATTS PEP TRANSMITTER OUTPUT

### ■ Conservatively-Designed 200 W MOSFET Final Amplifier

The MARK-V utilizes a pair of Philips BLF147 Power MOSFETs in a 30-Volt, push-pull configuration. These 300-Watt (150-Watt x 2) transistors are run well below their maximum ratings, ensuring high reliability and excellent signal purity. The time-proven Low-Pass Filter network, adopted from the FT-1000D, effectively suppresses harmonic energy while efficiently delivering at least 200 Watts to the antenna jack.



Philips MOS FET BLF147 / MOS FET BLF145

### ■ High-Speed Automatic Antenna Tuner

The basic circuitry from the widely-acclaimed Automatic Antenna Tuner of the FT-1000MP has been beefed up for operation at the 200-Watt level for incorporation in the MARK-V. Constructed on a glass-epoxy circuit board for maximum efficiency, the Automatic Antenna Tuner's dedicated microprocessor utilizes a complex analysis algorithm which permits lightning-quick matching of impedance mismatches. The result: more power delivered to the antenna, and less time wasted in tuning!



200-Watt Automatic Antenna Tuner

### ■ Revolutionary Heat Sink Design for Contest and DX-pedition Environments

Providing 200 Watts of momentary output from a compact transceiver enclosure is easy; creating an HF

powerhouse that will pump out full power for days at a time is tough! Yaesu's engineers, seeking to fulfill the needs of both contest and DX-pedition operators, have crafted an all-new, highly-efficient "T-configuration" heat sink for the MARK-V, providing double the heat-dissipating surface area and 2.5 times the cooling capacity of the heat sink on the FT-1000D! When the going gets tough, the thermostatically-controlled cross-flow ducting the heat across the dissipating fins and away from the case. This revolutionary new heat sink design ensures that the MARK-V will not let you down, even under the aggressive operating circumstances of an expedition to a rare tropical island!



T-Configuration Heat Sink

## II. CLASS-A PA OPERATION: WORLD PREMIERE BY YAESU!

### ■ Uniquely-Pure Signal Quality, Only from Yaesu!

The MARK-V is the first commercially-designed Amateur transceiver to provide Class-A operation for its power amplifier. When engaged by the front panel's [CLASS A] switch, the PA bias is changed dramatically, and the MARK-V then puts out a 75-Watt signal envelope of astounding purity. During Class-A operation, 3rd-

order Intermodulation Distortion (IMD) drops from a typical value of -31 dB to -50 dB or better, and 5th- and higher-order IMD (the kind which contributes to "splatter" reports) will drop to the -80 dB range! No Amateur transceiver has ever approached this degree of linearity in its power amplifier circuitry. And while the MARK-V's Class-A feature does not directly

affect your linear amplifier's performance, the extremely clean drive to your linear will result in dramatically cleaner overall signal reproduction. Be ready for other stations to say, "Wow! Your rig sounds great!"

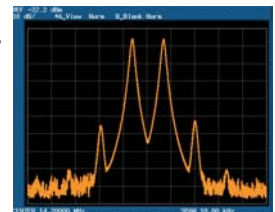

Class A 75W PEP IMD

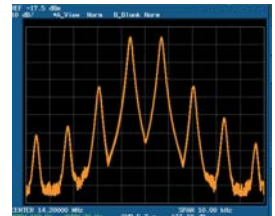

Class AB 200W PEP IMD

### Separate FP-29 Switching-Regulator Power Supply

So as to provide the 30 Volts required by the BLF147 MOSFET PA transistors, as well as the 13.8 Volts required by other transceiver circuitry, Yaesu's engineers have developed the FP-29 External Power Supply especially for the MARK-V. The external power supply concept significantly reduces the weight of the transceiver enclosure itself, providing greater safety when shipping the MARK-V to a DX-pedition site. The FP-29 is designed with a total output capability of 450 Watts, with a switching noise suppression of greater than 100 dB, all from an enclosure measuring just 4.2" (W) x 5.4" (H) x 13.0" (D) (approx. 106 x 136 x 331 mm). If you like, you can place the FP-29 on a shelf under your operating desk, and enjoy the compact size of the MARK-V even more!



### III. IDBT: INTERLOCKED DIGITAL BANDWIDTH TRACKING SYSTEM

**Interlocked Digital Bandwidth Alignment Technique**  
The MARK-V introduces a unique and formidable interference-fighting system with the development of IDBT, whereby the bandwidth of the Digital Signal Processing filter is automatically locked to be the same as the net bandwidth of the analog IF filters. Engaging the IDBT, the operator experiences a sudden sharpening of the shape factor of the receiver's filter system. The analog IF, which utilizes cascaded crystal and/or mechanical filters, includes both IF WIDTH and IF SHIFT controls, which allow modification of

the IF passband width and center frequency. With IDBT, the DSP filter is automatically re-programmed so as to match the custom bandwidth you just set, and the DSP filter then contributes a filtering slope which resembles a sheer cliff! The results? The incredible selectivity of an all-DSP system with the protection of the DSP afforded by the extensive IF analog filtering. What's more, the potential for AGC "pumping" caused by different analog and digital bandwidths is eliminated; thus, the need for separate analog and DSP AGC systems is also gone, eliminating

the very real danger of annoying cross-AGC artifacts which can seriously degrade receiver performance. New to the 455 kHz analog IF is a 10-Pole Collins® Mechanical SSB Filter, providing outstanding voice signal reproduction along with enhanced skirt selectivity compared to the FT-1000MP's 8-pole filter. The IDBT function is controlled by an allocation of up to 60 kbytes of ROM in the Main CPU, while the DSP performance utilizes 1 Mbyte of EEPROM! This perfect blending of the analog and digital worlds brings you, today's Elite-Class operator, the most crunch-proof receiver filtering ever!

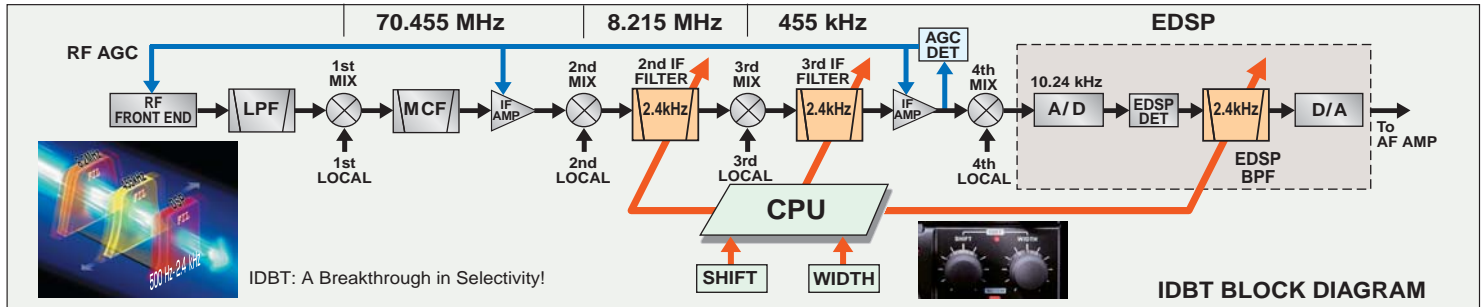

### IV. VARIABLE RF FRONT-END FILTER

**VRF Preselector Filtering Protects Receiver Front End (160M ~ 20M)**

Extending the protection afforded the sensitive front-end components of the receiver, Yaesu's engineers have developed the VRF module: a High-Q input "Preselector" filter ahead of all active devices in the front end, including the main bandpass filters! Particularly in multi-operator contest or DX-pedition environments, where large low-band antennas may be in close proximity, a receiver operating (for example) on 20 meters can suffer intermodulation interference from on-site 40- and 80-meter signals, compounded by extremely strong 7 MHz broadcast signals. The VRF circuit provides narrow-band selectivity which prevents this unwanted signal voltage from hitting the input side of the bandpass filter switching diodes, where 2nd-order IMD is most

often created in an HF receiver. Tuning of the VRF is incredibly simple: just turn the VRF/MEM CH knob, and peak the background noise or signal strength! The VRF is stoutly designed, with large (10 mm x 10 mm) coils yielding high Q, and precision tuning capacitors ensuring that performance does not degrade over time. A total of 31 tuning memories per band allow very quick QSX, and the use of high-quality, shielded relays for VRF selection ensures that nothing in the VRF can itself contribute IMD.

### Receiver Front End Highlights

The MARK-V adopts the low-noise front end design of the FT-1000MP. Two low-noise Junction FET preamplifiers are provided, one in a "tuned" configuration with optimized gain and noise figure independently for the high and low bands, with the other "flat" preamp providing a wide, uniform-gain response. The first mixer utilizes a quad of SST-310 Junction FETs in a doubly-balanced circuit, resulting in wide dynamic range. Eleven bandpass filter networks provide input protection for the front end, working in concert with the VRF to provide the best-ever 2nd-order IMD prevention in an Amateur transceiver.

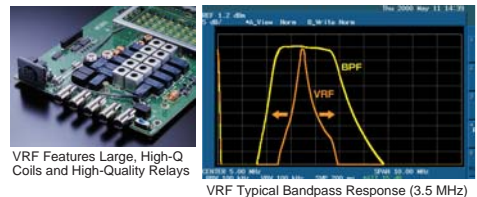
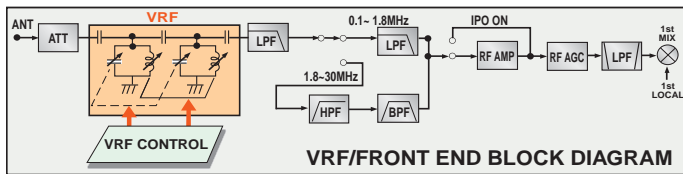

### V. ENHANCED ERGONOMICS: MULTI-FUNCTION SHUTTLE JOG DIAL

**Quick Access to VRF and IDBT via Shuttle Jog Tuning Ring**  
The immensely-popular Shuttle Jog tuning ring, which is concentric with the Main Tuning Knob, has a new look in the MARK-V: it now includes the activation switches for the VRF (left side)

and IDBT (right side) features, so the operator does not have to move his hand position to activate these important circuits during contest or pile-up situations!

**Superb Ergonomics Across the Front Panel**  
Both the Main and Sub VFO Tuning Knobs are larger, allowing silky-smooth tuning even if you have large fingers! The right side

of the front panel contains the adjustment controls for the VRF, IDBT, NOTCH, and CLARIFIER, conveniently grouped so you can get at them quickly. For contest or DX-pedition use, you cannot afford to lose even milliseconds in search of a frequently-used control. And the most popular EDSP functions from the FT-1000MP are now much easier to use! The CW Audio Peaking Filter (with bandwidths of 60, 120, and 240 Hz) and the four-position EDSP Noise Reduction (NR) feature are conveniently located just to the left of the Main Tuning Dial, for quick, convenient push-button access. Right next to the APF and NR controls are the three EDSP response Contour selections, which enhance signal-to-noise ratio by matching the DSP frequency response to the unique shape of the incoming signal envelope.



Large-diameter control knobs make precise adjustments easy!

# HF 200W ALL MODE TRANSCEIVER MARK-V FT-1000MP

The development of an Elite-Class HF Transceiver is not accomplished in a vacuum. It is a team effort, drawing on the unique abilities of Yaesu's Research and Development experts, our most senior HF Design Engineers, and extensively utilizing the comments and recommendations of hundreds of DX and contest operators. Today's bands demand leading-edge features, and the MARK-V is without peer when it comes to performance and innovation.

## ENHANCED DIGITAL SIGNAL PROCESSING

Acclaimed by DX operators worldwide for its wide-ranging capabilities, Yaesu's Enhanced Digital Signal Processing (EDSP) circuitry is a key component in the system-wide filtering effort which stretches from the antenna ports to the microphone or speaker.



EDSP Unit

### Highly-Effective Digital Noise Reduction Circuit

Utilizing mathematical algorithms developed after thousands of hours of on-the-air evaluation, the EDSP Noise Reduction provides four different Noise Reduction patterns, to allow you to cope with changing noise conditions. The algorithms utilized in the development of the EDSP Noise Reduction cover the vast majority of noise patterns encountered on the HF bands.

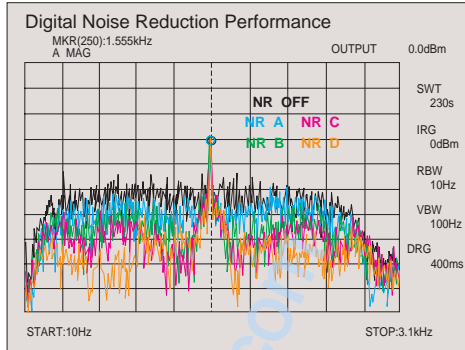

### Optimized Narrow-Bandwidth Filters for CW and Data Modes

For razor-sharp selectivity under marginal conditions, the EDSP CW Audio Peaking Filter provides bandwidths of 60, 120, or 240 Hz. Filter selection is accomplished using a convenient pushbutton switch on the left side of the front panel.

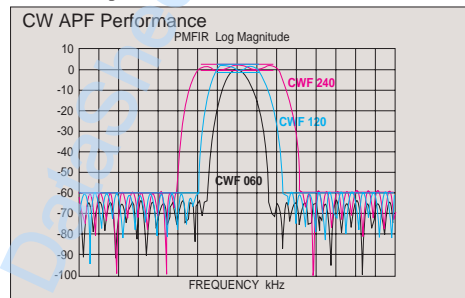

Besides the CW Audio Peaking Filter, specially-designed and optimized digital-mode filters are provided, for maximum data throughput on RTTY, Packet, SSTV, PSK31, or FAX.

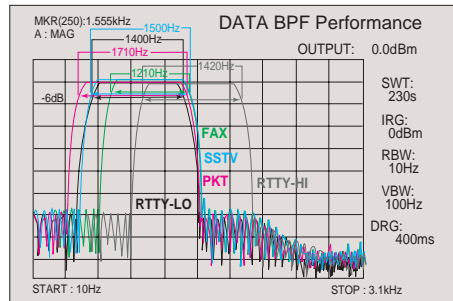

### Selectable SSB Pattern-Contour Filters

Particularly effective in enhancing signal-to-noise ratio and intelligence recovery on SSB signals, the Contour selections include High-Cut, Low-Cut, and Mid-Cut responses, with a color-coded indicator aiding in filter selection. Choose the one that causes the incoming voice to "pop" out of the background noise!

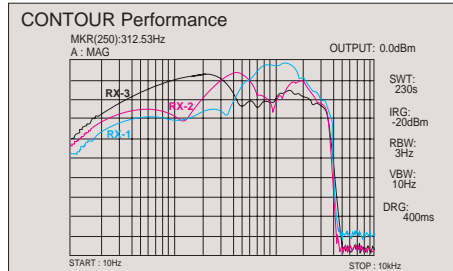

### Selectable Digital Modulation/Demodulation

Among EDSP's more advanced technology are the digital Modulator and Demodulator circuits. On transmit, the EDSP Modulator provides improved transmitter signal-to-noise ratio, very flat frequency response, and a choice of four cutoff frequencies (100, 150, 200, or 300 Hz) on the low-frequency side (high-frequency cutoff: 3100 Hz). Whether you're rag-chewing or in a DX contest, the MARK-V provides a frequency response that's ideal for you!

Providing a boundary for the receiver's SSB bandwidth within the EDSP, you can select either 100-3100 Hz or 300-2800 Hz filters in the EDSP Demodulator circuit, which provides very low noise with no odd DSP artifacts or distortion.

### Digital SSB Microphone Equalizer & RF Speech Processor

Similar in concept to the "Contour" feature used on receive, one of the four different microphone equalization filters may be engaged so as to provide the most effective, penetrating audio "punch" for your voice and microphone. Working to enhance "talk power" even more, the RF

Speech Processor provides a clean increase in average power output, through a carefully-designed envelope compression technique proved so successful in the FT-1000MP.

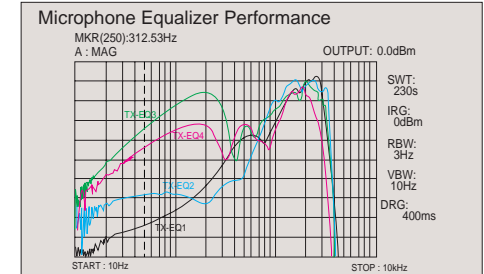

### Digital Auto-Notch

The Digital Auto-Notch seeks out and reduces or eliminates annoying "beat" signals that can ruin reception. Especially effective when used in a "combined" mode with the 455 kHz IF Notch (which typically provides rejection in excess of 70 dB!), the Digital Auto-Notch is a tremendous aid in providing operator comfort during long operating sessions.

## DUAL RECEIVE WITH INDEPENDENT AGC SYSTEMS

### Listen to Two Frequencies Simultaneously with No AGC Interaction!

On some "Dual Receive" transceivers, the AGC corresponding to the signals present on the "Main" frequency affect what's happening on the "secondary" frequency (which can cause a signal to disappear on the 2nd frequency!). The MARK-V utilizes two completely independent receivers, each with its own IF filter(s) and AGC loops, so that you can listen to two frequencies (on the same band) simultaneously with no interaction.

The audio levels for the two receivers may be adjusted independently, of course, and you can select either "Stereo", "Mixed" (partially combined), or "Monaural" (fully combined) audio for your headphones. And the AF-REV switch allows the functions of the AF GAIN (Main) and the SUB AF volume controls to be reversed, if desired.

Ideal for contest operation (for watching for "multipliers") or for DX pile-up use (for monitoring both sides of the pile-up), the MARK-V's Dual Receive system ensures that you're always on top of the action!

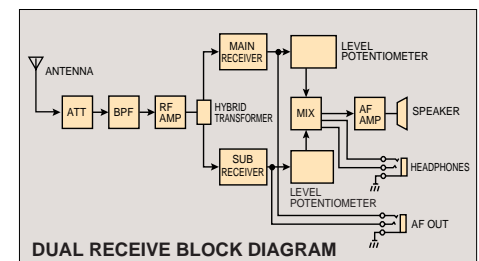

# As the world enters a new millennium, new chapter in the history books, with



Photo shows optional MD-100A8X Deluxe Desk Microphone



### ■ Easy-Access "SPLIT" Operation

When seconds count in a DX pile-up, the convenience of the MARK-V's "SPLIT" operating mode can't be beat! The "RX" (green) and "TX" (red) LEDs above the Main and Sub VFO tuning dials are actually combination LED/Switches; pressing the Sub VFO's "TX" LED automatically shifts the transmitter to control by the Sub VFO, with receiver control still on the Main VFO. Pressing the Sub VFO's "RX" LED activates Dual Receive, so you're listening on both VFOs, while transmitting on the Sub VFO. It's easy, it's intuitive, and it's quick!

### INDUSTRY-LEADING RF FRONT END DESIGN

DX-pedition and Contest operators alike have acclaimed the strong-signal performance and antenna selection convenience of the FT-1000D/FT-1000MP. This legacy is renewed in the MARK-V FT-1000MP!

### ■ Two TX/RX Antenna Ports plus Receive-only Antenna Line Jacks

The "A" and "B" antenna jacks allow connection of different antennas, which may be selected using the front panel's A/B switch. The antenna selected on a particular VFO/memory and band will be preserved in that VFO or memory register, and will be automatically recalled when you return to that VFO or memory. The RX "In" and "Out" jacks allow connection of a Beverage or loop receiving antenna, and may also be used to connect a special receive-line filter, if desired.

### ■ Three RF Preamp Modes plus IPO (Direct Mixer Feed)

The wide variations in noise and signal levels on the HF bands demand a customized approach to receiver front end gain. The MARK-V provides separate, optimized preamplifiers for the Low (7 MHz and below), Mid (10 ~ 21 MHz), and High (24.89 MHz and up) HF bands. If front end preamplification is not needed, pressing the IPO (Intercept Point Optimization) button will bypass the RF preamp stage, routing the RF energy directly to the first mixer, and increasing the 3rd-order Intercept Point accordingly.

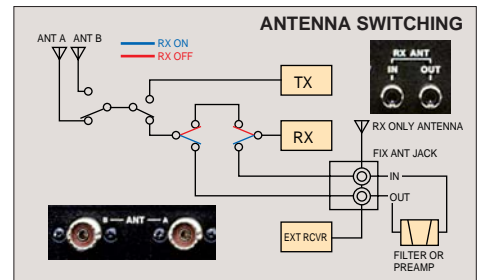

### ■ Four-Level Input RF Attenuator

For fine-tuning the front-end gain, or for comfortable listening to extremely strong local signals, the Attenuator circuit provides 6/12/18 dB of gain reduction (plus "Off").

### ■ RF GAIN Control

For precise setting of the background noise level, or for modifying the receiver's AGC threshold, the front panel's RF GAIN control is conveniently located on the same shaft as the main receiver's AF GAIN control.

### ■ AUTO-AGC

For ease in operation, the "AUTO" AGC mode provides mode-specific selection of the receiver recovery time for the Automatic Gain Control system. Manual selections of FAST, SLOW, and OFF are also provided.

# Yaesu is proud to turn the page to an exciting the release of the MARK-V FT-1000MP!



HF 200W ALL MODE TRANSCEIVER  
**MARK-V** FT-1000MP

## OUTSTANDING IF FILTER CHAIN

Yaesu's hybrid Analog/DSP IF design reflects our commitment to bring you the toughest, most QRM-resistant receiver possible!

### Carefully-Specified 8.2 MHz and 455 kHz IF Filters

Both 2.4 kHz and 500 Hz 8-pole crystal filters for the 2nd (8.2 MHz) IF are factory installed, and the 455 kHz (3rd) IF includes a 10-pole Collins® Mechanical SSB Filter. Optional filters are available at bandwidths of 2.0 kHz or 250 Hz (2nd and 3rd IFs), and 500 Hz (3rd IF and Sub Receiver). The outstanding shape factors of these filters combine with the IDBT digital filtering to provide brick-wall selectivity with outstanding close-in performance.

### 455 kHz IF NOTCH features Improved Rejection

The newly-designed 455 kHz IF Notch Filter provides improved beat rejection, typically 50 dB or more. Use the front-panel NOTCH control to adjust the exact position of the Notch.

The MARK-V may be configured (via the convenient Menu system) to engage both the manual IF Notch Filter and the DSP Auto-Notch Filter, allowing cascaded Analog/Digital Notch Filtering. Say "Good-bye" to irritating beatnotes forever!

## IF Filter Bandwidth Selections

### Factory-installed IF Filter Selections

BAND WIDTH	NOR (NOR)		NAR1 (NAR1)		NAR2 (NAR2)	
	2nd IF (8.2MHz)	3rd IF (455kHz)	2nd IF (8.2MHz)	3rd IF (455kHz)	2nd IF (8.2MHz)	3rd IF (455kHz)
SSB	2.4kHz	2.4kHz	2.4kHz	2.4kHz	-	-
CW	2.4kHz	2.4kHz	500Hz	2.4kHz	-	-
AM	THRU	6.0kHz	2.4kHz	2.4kHz	-	-
RTTY PKT (LSB)	2.4kHz	2.4kHz	-	-	500Hz	2.4kHz

### IF Filter Selections with All Options Installed

BAND WIDTH	NOR (NOR)		NAR1 (NAR1)		NAR2 (NAR2)	
	2nd IF (8.2MHz)	3rd IF (455kHz)	2nd IF (8.2MHz)	3rd IF (455kHz)	2nd IF (8.2MHz)	3rd IF (455kHz)
SSB	THRU	6.0kHz	2.4kHz	2.4kHz	2.0kHz (YF-114SN)	2.0kHz (YF-110SN)
CW	2.0kHz (YF-114SN)	2.0kHz (YF-110SN)	500Hz	250Hz (YF-115C)	250Hz (YF-114CN)	250Hz (YF-110CN)
AM	THRU	6.0kHz	2.4kHz	2.4kHz	2.0kHz (YF-114SN)	2.0kHz (YF-110SN)
RTTY PKT (LSB)	2.0kHz (YF-114SN)	2.0kHz (YF-110SN)	500Hz	500Hz (YF-115C)	250Hz (YF-114CN)	250Hz (YF-110CN)

※ On FM, the Bandwidth switches are disabled.



New 10-pole Collins® Mechanical SSB Filter Passband Response

### Dual-Mode IF Noise Blanker

The adjustable IF Noise Blanker may be configured for optimum blanking of (A) narrow-pulse ignition-type noises, or (B) wide-pulse over-the-horizon radar systems.

### Synchronous AM Detection for Reduced Fading

The "Synchronous" detection technique provides improved AM reception by significantly reducing fading. The

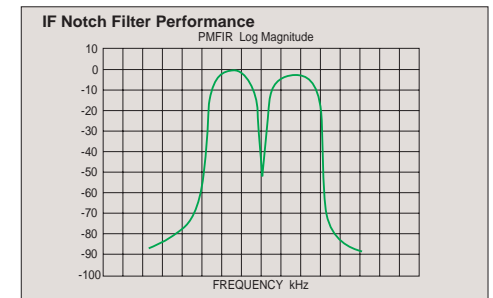

incoming signal is removed, reception is converted to SSB, and a non-fading carrier is re-inserted, thereby eliminating the chief cause of fading. A Synchronous Tuning Scale on the display assists in the tuning process.

## CW FEATURES FOR OPERATORS DEMANDING THE BEST

### ■ CW Full Break-in and Electronic Keyer

The ultra-fast response time of the Direct Digital Synthesizer (DDS) allows full break-in (QSK) operation, without perceptible character truncation. The built-in electronic keyer features separate Dot:Space and Dash:Space weight settings, and the receiver recovery time during semi-break-in work may be set optimally for CW, independently from the SSB "VOX Delay" setting.

### ■ CW Spot

Align yourself precisely with the station being worked by the DX station in a pile-up.



### ■ CW Pitch

Select filter center frequency, TX offset, and Sidetone pitch over the range 300-1050 Hz, and use the SPOT switch to zero in on the other station.

### ■ CW Reverse Tuning

Choose either USB- or LSB-side injection to combat interference, or to switch a station from SSB to CW without guesswork as to the operating frequency!

### ■ CW Tuning Indicator

Provides visual confirmation of precise tuning on receive.



### ■ Two Key Jacks

Front- and rear-panel paralleled KEY jacks allow easy connection to paddles, external electronic keyers, or computer-driven keying interfaces.

### ■ Electronic Memory Keyer

Use the optional FH-1 Remote Keypad (or build your own keypad) to activate the onboard electronic message memory keyer. Four messages of up to 50 characters each may be programmed, and an incrementing contest number may also be imbedded into a recorded message.

## CONVENIENCE FEATURES FOR WORLD-CLASS HF OPERATORS

The FT-1000D and FT-1000MP were universally acclaimed, not only for their industry-leading RF and IF innovations, but also for the wealth of operating conveniences made available to demanding HF operators. The MARK-V FT-1000MP builds on this tradition, and makes it even better!

### ■ Unmatched Ergonomic Front Panel Design Concept

Owners of Yaesu's FT-1000 family of Elite-Class transceivers use them under the most stressful conditions. Over long hours of operation, the carefully designed front-panel ergonomics are a profound asset for the operator, whether on a DX-pedition on a faraway island or at home at 4 o'clock in the morning. Borrowing extensively from the FT-1000MP front panel layout, the MARK-V features larger knobs, reduction in the total knob/button count, and enhanced ease of operation as a result of the intensive ergonomic system analysis applied by Yaesu's engineers. This effort, coupled with feedback from users like you, has resulted in an incredibly complex transceiver also being incredibly easy to use!

### ■ Multi-Function Display with Improved Contrast

The MARK-V's multi-function display provides a wealth of transceiver status in a conveniently-arranged layout, and it boasts improved contrast compared to previous designs. The area around the Main VFO frequency display contains the most-often-used information, such as Clarifier Offset, VRF Tuning Scale, Antenna Tuner status, and VFO / Memory status.



### ■ High-Resolution DDS Provides Silky-Smooth Tuning

Yaesu pioneered the use of the DDS (Direct Digital Synthesizer) in modern HF transceivers, and the MARK-V's DDS system is the latest, greatest evolution of this design technique. The DDS provides ultra-fine tuning steps as small as 0.625 Hz, ideal for the slow tuning needed for HF digital work. And the very low noise of the DDS-based local oscillator system yields a very low noise floor during reception and transmission.



### ■ Enhanced Shuttle Jog™ Tuning Dial

Instantly popular on the original FT-1000MP, the Shuttle Jog™ dial, concentric with the Main VFO tuning dial, is a spring-loaded center-off tuning aid which allows the operator to make progressively larger scans up and down the band by "leaning" on the Shuttle Jog™ to the left or right. A slight displacement of the dial causes tuning in 10 Hz steps, and full rotation of the dial to the left or right yields steps as large as 100 kHz per step—you'll watch the Megahertz fly by if you need to QSY quickly! The Shuttle Jog™ tuning speed may be adjusted via the Menu system, so you can set it up just the way you want it! And with the addition of the VRF and IDBT On/Off switches on the Shuttle Jog™ ring, you'll find little need for your hand from the central area of the transceiver during critical moments!

### ■ VRF/MEM Channel Selector

The VRF/MEM Channel Selector knob, located in the upper right-hand corner of the front panel, also functions as a VFO Channel Selector for quick and easy QSY in user-programmer steps of 1 to 100 kHz. Use 1 kHz to 5 kHz steps for cruising up and down the band, or 50 kHz steps for general-coverage frequency hopping. A simple press on this control restores VRF (Preselector) operation, and you'll be ready for action!

### ■ Direct Keypad Frequency Entry; Twin Stacked VFO Registers

The convenient 10-key direct frequency entry keypad provides instant frequency setting anywhere within the range of the transceiver. The "Band" keys on the keypad also provide one-touch band change, and the two VFOs available per amateur band allow one VFO to be set for the CW segment, and the other for the phone segment, with the mode, bandwidth, and antenna selections for each segment being automatically memorized into each VFO register.

### ■ Feature Customization Menu

For configuration of the MARK-V just the way you want it, many "set and forget" features and functions may be customized via the Menu system. The Menu provides access to the settings for a number of operating parameters which are not needed during everyday operation; the use of the Menu technique significantly reduces the total number of knobs and switches on the front panel, making long hours of operation even more enjoyable.



### ■ Extensive Memory System, including 5-Channel Quick Memory Bank (QMB)

The MARK-V provides 99 regular memory channels, five QMB memories, and nine "band limit" memories. The "regular" memories may be assigned into one of five memory "groups", for convenience in recalling of the memories. Besides the operating frequency, memory channels store operating mode, antenna selection, Clarifier offset (if any), IF filter selection, and repeater shift status (if applicable).



### ■ Versatile Scanning Capability

The acclaimed scanning features of the MARK-V include a number of capabilities which make HF operation a breeze. These include:

- Memory/VFO Scan: Scan the memories, or scan the band, with the scanning speed being adjustable, via Menu, independently for Memory and VFO Scan. An Auto-Write feature allows "busy" channels to be written into memory automatically, if desired.
- Memory Channel "Skip" Scanning: You can "flag" certain memories to be skipped during scanning, so the transceiver is not constantly halting on constantly-busy frequencies like WWV.
- Programmable Memory Scan (PMS): You may use and scanning. For example, within the 18.0-18.5 MHz range, you may limit operation to the range 18.068 to 18.168 MHz, to prevent accidental excursions outside the amateur band segment.

### ■ Easy Digital-Mode Interfacing

The exciting world of digital mode operation is more popular than ever! And the MARK-V is unmatched in its ease of interfacing, whether you're interested in PSK-31, RTTY, Packet, SSTV, or Fax. Dedicated rear-panel FSK and AFSK jacks make cabling a breeze, and customized EDSP and IF filter selections make sure that you're never forced to use a non-optimal bandwidth during digital operation.



### ■ Built-in Temperature-Compensated Reference Oscillator

The TCXO-4 Temperature-Compensated Reference Oscillator, which was an extra-cost option on the original FT-1000MP, is built into every MARK-V. The TCXO-4 provides frequency accuracy of 0.5 ppm at 25°C, and 2.0 ppm over the temperature range -10°C to +50°C. For ultra-precise frequency accuracy, the optional TCXO-6 provides accuracy of 0.25 ppm at 25°C, and 0.5 ppm at -10°C to +50°C.

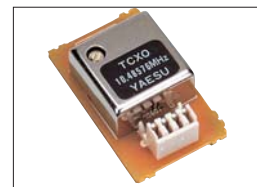

## AND SO MUCH MORE

- General Coverage Reception: 100 kHz ~ 30 MHz.
- Large, high-quality speaker (3-5/8" / 92 mm) for better receive audio clarity.
- Two headphone jacks: one each 6 and 3.5 mm.
- Adjustable "Beep" tone for keypad keys.
- Adjustable torque for tuning knobs.
- Built-in VOX.
- FAST tuning key for quick frequency change.
- Built-in RS-232C level converter for easy computer interfacing.

## SPECIFICATIONS

### General

RX Frequency Range : 100 kHz ~ 30 MHz  
 TX Frequency Ranges : 160 ~ 10 m (Amateur bands only)  
 Frequency Stability : ± 0.5 ppm (after 1 min. @ 25 °C)  
 ± 0.25 ppm (after 1 min. @ 25 °C, w/TCXO-6)  
 Operating Temperature Range: -10 °C ~ +50 °C  
 Emission Modes : LSB, USB, CW, FSK, AFSK, AM, FM  
 Frequency Steps : 0.625/1.25/2.5/5/10 Hz for  
 SSB, CW, RTTY & Packet  
 100 Hz for AM and FM  
 Antenna Impedance : 16.6~150 Ohms, unbalanced  
 (Tuner ON, TX only)  
 Power Consumption : 13.8 VDC 30 VDC  
 RX (no signal) 2.3 A -  
 RX (signal) 2.7 A -  
 TX (200 W) 2.2 A 14.5 A  
 Supply Voltage : 30 VDC and 13.8 VDC (FP-29)  
 Dimensions (WHD) : 16 "x 5.3 "x 13.7 "  
 (410 x 135 x 347 mm)  
 Weight (approx.) : 31 lbs. (14 kg.)

### Transmitter

Power Output : Adjustable up to 200 watts  
 (50 watts AM carrier),  
 Class A mode (SSB) : 75 watts maximum  
 Duty Cycle : 100% @ 100 watts,  
 50% @ 200 watts (FM & RTTY, 3-minute TX)  
 Modulation Types: SSB: J3E Balanced,  
 AM: A3E Low-level (early stage),  
 FM: F3E Variable reactance,  
 AFSK : J1D, J2D Audio frequency shift keying  
 Maximum FM Deviation: ± 2.5 kHz  
 FSK Shift Frequencies: 170, 425, and 850 Hz  
 Packet Shift Frequencies: 200 and 1000 Hz  
 Harmonic Radiation : Better than -60 dB (Typical)  
 SSB Carrier Suppression: At least 40 dB below peak output  
 Undesired Sideband Suppression: At least 55 dB below peak output  
 Audio Response (SSB): Not more than -6 dB  
 from 400 to 2600 Hz  
 3rd-order IMD: - 31 dB @ 200 watts PEP, or better  
 (Class A mode) - 50 dB @ 75 watts PEP (Typical)  
 Microphone Impedance: 500 to 600 Ohms

### Receiver

Circuit Type : Quad-conversion superheterodyne  
 (triple conversion for FM)  
 Intermediate Frequencies:  
 Main RX: 70.455 MHz/8.215 MHz/455 kHz,  
 Sub RX: 47.21 MHz/455 kHz  
 Sensitivity : 

Modes	0.5 - 1.8 MHz	1.8 - 30 MHz
SSB/CW (2.0 kHz)	2 μV	0.16 μV
AM (6 kHz)	13 μV	2 μV
FM	-	0.5 μV

  
 (with preamp on, IDBT on, SSB/CW/AM for 10 dB S/N,  
 FM for 12 dB SINAD, 0 dB μ = 1 μV)  
 Selectivity (-6/-60 dB): 

Bandwidth	Modes	Min. -6 dB BW	Max. -60 dB BW
2.4 kHz	all except FM	2.2 kHz	4.2 kHz
2.0 kHz	all except FM	1.8 kHz	3.6 kHz
500 Hz	CW/RTTY/Packet	500 Hz	1.8 kHz
250 Hz	CW/RTTY/Packet	250 Hz	700 Hz
	AM (Wide)	4 kHz	14 kHz
	FM	8 kHz	19 kHz



IF Rejection (1.8 ~ 30 MHz):  
 80 dB or better (Main RX), 60 dB or better (Sub Rx)  
 Image Rejection (1.8 ~ 30 MHz):  
 80 dB or better (Main), 50 dB or better (Sub)  
 Maximum Audio Output:  
 2.0 W into 4 Ohms with <10 %  
 THD

### FP-29 Specifications

DC Output Voltage/Current: +30 V: 15 A; +13.8 V: 3 A  
 Input Voltage : AC 100-120 V, 50-60 Hz  
 AC 200-240 V, 50-60 Hz  
 Current Consumption (Approx.): AC 100-120 V: 9 A, AC 200-240 V: 5 A  
 Operating Temperature Range: -10 °C ~ +50 °C  
 Case Size (W x H x D): 4.2 "x 5.3 "x 13 " (106 x 135.5 x 331 mm)  
 Weight (Approx.): 7 lbs. (3.2 kg.)  
 Specifications are subject to change, in the interest of technical  
 improvement, without notice or obligation.

## OPTIONAL ACCESSORIES

Desktop Microphone MD-100ABX	Hand Microphone MH-31Ba	Digital Voice Recorder DVS-2	Remote Control Keypad FH-1		
			<b>2nd IF (8.2 MHz) Filters</b>  SSB 2.0 kHz X'tal Filter YF-114SN  CW 250 Hz X'tal Filter YF-114CN		<b>3rd IF (455 kHz) Filters</b>  SSB 2.0 kHz X'tal Filter YF-110SN  CW 250 Hz X'tal Filter YF-110CN  CW 500 Hz Filter (Collins Mechanical Filter) YF-115C <small>*For Main Rcvr and 2nd IF Sub Rcvr</small>
Lightweight Stereo Headphone YH-77STA	Temperature Compensated X'tal TCXO-6	External Speaker w/Audio Filters SP-8 LL-7 Phone Patch Option			

About this brochure: we have made this brochure as comprehensive and factual as possible. We reserve the right, however, to make changes at any time in equipment, optional accessories, specifications, model numbers, and availability. Some accessories shown herein may not be available in some countries. Some information may have been updated since the time of printing; please check with your Authorized Yaesu Dealer for complete details.

**YAESU VERTEX STANDARD CO., LTD.**  
 4-8-8 Nakameguro, Meguro-ku, Tokyo 153-8644, Japan

For the latest Yaesu news, visit us on the Internet:  
<http://www.vxstdusa.com> <http://www.yaesu.co.uk>

**VERTEX STANDARD** Phone 562/404-2700; Fax 562/404-1210  
 Email: amateursales@vxstdusa.com

**US Headquarters**  
 17210 Edwards Road, Cerritos, CA 90703, U.S.A.  
**International Division**  
 8350 N.W. 52nd Terrace, Suite 201, Miami, FL 33166, U.S.A.

**YAESU EUROPE B.V.**  
 P.O. Box 75525 1118 ZN, Schiphol The Netherlands

**YAESU UK LTD.** Email: sales@yaesu.co.uk  
 Unit 12, Sun Valley Business Park, Winnall Close  
 Winchester, Hampshire, SO23 0LB, U.K.

**VERTEX STANDARD HK LTD.**  
 Unit 5, 20/F., Seaview Centre, 139-141 Hoi Bun Road,  
 Kwun Tong, Kowloon, Hong Kong