

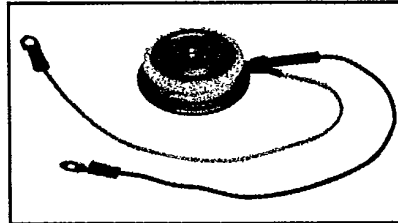

**FT300DL**

Powerex, Inc. Hills Street, Youngwood, Pennsylvania 15697 (412) 925-7272  
 Powerex Europe, S.A., 428 Ave. G. Durand, BP107, 72003 LeMans, France (43) 72.75.15

**Phase Control SCR**  
**300 Amperes Avg**  
**200-1200 Volts**

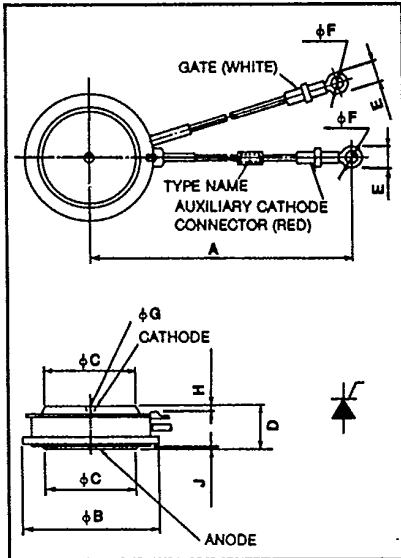

**FT300DL**  
**Phase Control SCR**  
 300 Amperes/200-1200 Volts

**FT300DL**  
**Outline Drawing**

Dimensions	Inches	Metric
A	12.60 ± .30	320 ± 8
φB	1.968 Max	50 Max
φC	1.220	31
D	.57 ± .02	14.5 ± 0.5
E	.30	7.5
φF	.169	4.3
φG <sup>1</sup>	.138	3.5
H	.04 Min	1.0 Min
J	.02 Min	.04 Min

<sup>1</sup>Depth .04 In. or 1 mm

**Description**

Powerex Silicon Controlled Rectifiers (SCR) are designed for phase control applications. These are all-diffused, Press-Pak (Pow-R-Disc) devices employing the field-proven amplifying (di/namic) gate.

**Features:**

- Low On-State Voltage
- High di/dt
- High dv/dt
- Hermetic Packaging
- Excellent Surge and I<sup>2</sup>t Ratings

**Applications:**

- Power Supplies
- Battery Chargers
- Motor Control
- Light Dimmers
- VAR Generators

**Ordering Information**

Example: Select the complete eight or nine digit part number you desire from the table - i.e. FT300DL-16 is a 800 Volt, 300 Ampere Phase Control SCR.

Type	Voltage*		Current
	V <sub>DRM</sub> V <sub>RRM</sub>	Code	
FT300DL	200	-4	300
	300	-6	
	400	-8	
	500	-10	
	600	-12	
	800	-16	
	1000	-20	
1200	-24		

\*Voltage classes 8, 12, 16, and 24 are standard; others are special products



Powerex, Inc., Hillis Street, Youngwood, Pennsylvania 15697 (412) 925-7272

Powerex Europe, S.A., 428 Ave. G. Durand, BP107, 72003 LeMans, France (43) 72.75.15

### FT300DL

Phase Control SCR

300 Amperes Avg/200-1200 Volts

### Absolute Maximum Ratings

	Symbol	FT300DL	Units
RMS On-State Current	$I_{T(RMS)}$	470	Amperes
Average On-State Current	$I_{T(av)}$	300	Amperes
Peak One-Cycle Surge (Non-Repetitive) On-State Current (60Hz)	$I_{TSM}$	8000	Amperes
Peak One-Cycle Surge (Non-Repetitive) On-State Current (50Hz)	$I_{TSM}$	7300	Amperes
Critical Rate-of-Rise of On-State Current (Non-Repetitive)	di/dt	500	Amperes/ $\mu$ s
Critical Rate-of-Rise of On-State Current (Repetitive)	di/dt	200	Amperes/ $\mu$ s
$I^2t$ (for Fusing), one cycle at 60Hz	$I^2t$	$2.7 \times 10^6$	A <sup>2</sup> sec
Peak Gate Power Dissipation	$P_{GM}$	10	Watts
Average Gate Power Dissipation	$P_{G(av)}$	5	Watts
Storage Temperature	$T_{STG}$	-40 to 150	$^{\circ}$ C
Operating Temperature	$T_J$	-40 to 125	$^{\circ}$ C
Mounting Force <sup>Ⓞ</sup>		800 to 1000	lb.
Mounting Force <sup>Ⓞ</sup>		360 to 450	kg

### Electrical and Thermal Characteristics

Characteristics	Symbol	Test Conditions	FT300DL	Units
<b>Voltage—Blocking State Maximums</b>				
Forward Leakage, Peak	$I_{DRM}$	$T_J = 125^{\circ}$ C, $V_{DRM}$ applied	30	mA
Reverse Leakage, Peak	$I_{RRM}$	$T_J = 125^{\circ}$ C, $V_{RRM}$ applied	30	mA
<b>Current—Conducting State Maximums</b>				
Peak On-State Voltage	$V_{TM}$	$I_{TM} = 940$ A, $T_J = 125^{\circ}$ C	1.50	Volts
<b>Switching</b>				
Min. Critical dv/dt exponential to $V_{DRM}$	dv/dt	$T_J = 125^{\circ}$ C, $V_D = \frac{1}{2}V_{DRM}$	200	V/ $\mu$ sec
<b>Thermal</b>				
Maximum Thermal Resistance, <sup>Ⓞ</sup> double sided cooling Junction to Sink	$R_{\theta JS}$		.09	$^{\circ}$ C/Watt
<b>Gate—Maximum Parameters</b>				
Gate Current to Trigger	$I_{GT}$	$V_D = 6$ V, $T_J = 25^{\circ}$ C, $R_L = 2\Omega$	200	mA
Gate Voltage to Trigger	$V_{GT}$	$V_D = 6$ V, $T_J = 25^{\circ}$ C, $R_L = 2\Omega$	2.5	Volts
Non-Triggering Gate Voltage	$V_{GDM}$	$T_J = 125^{\circ}$ C, $V_D = \frac{1}{2}V_{DRM}$	.20	Volts
Peak Forward Gate Current	$I_{GTM}$		4	Amperes
Peak Reverse Gate Voltage	$V_{GRM}$		5	Volts

<sup>Ⓞ</sup> Consult recommended mounting procedures.



Powerex, Inc., Hillis Street, Youngwood, Pennsylvania 15697 (412) 925-7272  
 Powerex Europe, S.A., 428 Ave. G. Durand, BP107, 72003 LeMans, France (43) 72.75.15

FT300DL  
 Phase Control SCR  
 300 Amperes Avg/200-1200 Volts

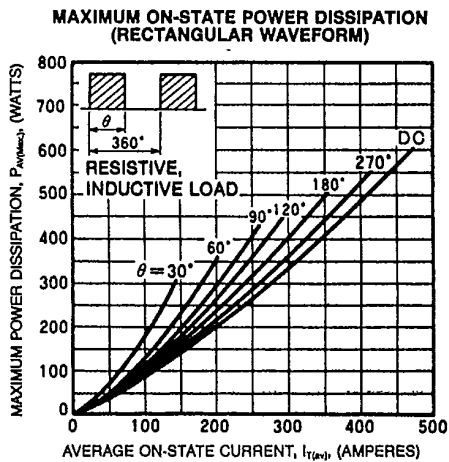
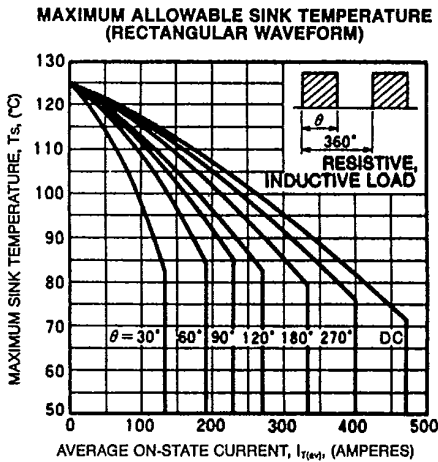
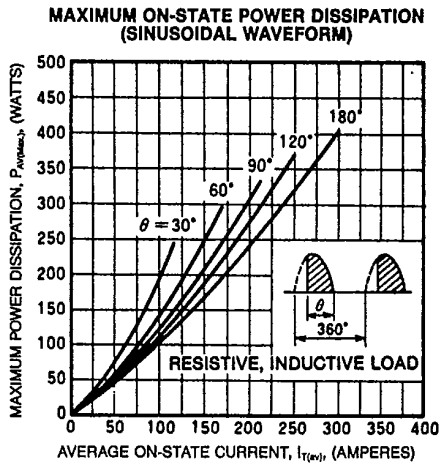
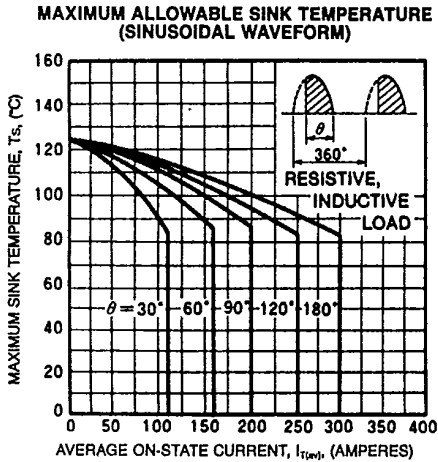
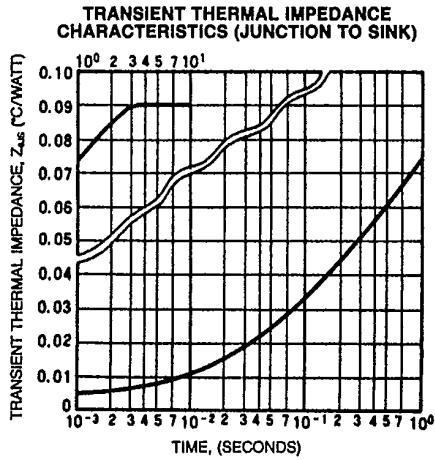
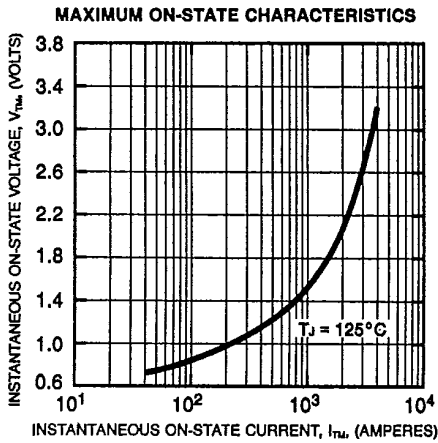



Powerex, Inc., Hillis Street, Youngwood, Pennsylvania 15697 (412) 925-7272  
 Powerex Europe, S.A., 428 Ave. G. Durand, BP107, 72003 LeMans, France (43) 72.75.15

**FT300DL**  
 Phase Control SCR  
 300 Amperes Avg/200-1200 Volts

