

GENERAL DESCRIPTION

The ft690 is a mono Class-AB audio power amplifier designed for demanding applications in mobile phones and other portable media devices. It is capable of delivering 1.25W of continuous output power to an 8Ω BTL load with less than 1% distortion (THD+N) from a 5VDC power supply.

The ft690 is specifically designed to provide high quality output power with a minimal number of external components. The ft690 does not require output coupling capacitors or bootstrap capacitors, and is therefore ideal for use in mobile phones and other low voltage applications where minimal power consumption is a primary requirement.

The ft690 features a low-power shutdown mode. In the shutdown mode where a logic low is applied onto the \overline{SD} pin, the amplifier is completely turned off and no supply current will flow through the device.

The ft690 also features advanced pop & click circuitry which eliminates noise which would otherwise occur during turn-on and turn-off transitions.

The ft690 is unity-gain stable and can be configured by external gain-setting resistors.

FEATURES

- Ultra low current in shutdown mode
- Low quiescent current
- Improved pop & click circuitry eliminates noise during turn-on and turn-off transitions
- Supports both single-end and differential inputs
- Wide operating voltage range: 2.5 ~ 5.5V
- No output coupling capacitors, snubber networks or bootstrap capacitors required
- Available in space-saving package
COL1.5X1.5-9L
MSOP-8L

KEY SPECIFICATIONS

- Improved PSRR at 217Hz : 66dB
- Power Output at 5V, 1% THD+N, 8Ω: 1.25W
- Power Output at 3V, 1% THD+N, 8Ω: 425mW
- Quiescent Current 1.6mA (VDD=3V)

APPLICATIONS

- Mobile phone
- PDA
- Portable electronic devices

APPLICATION CIRCUIT

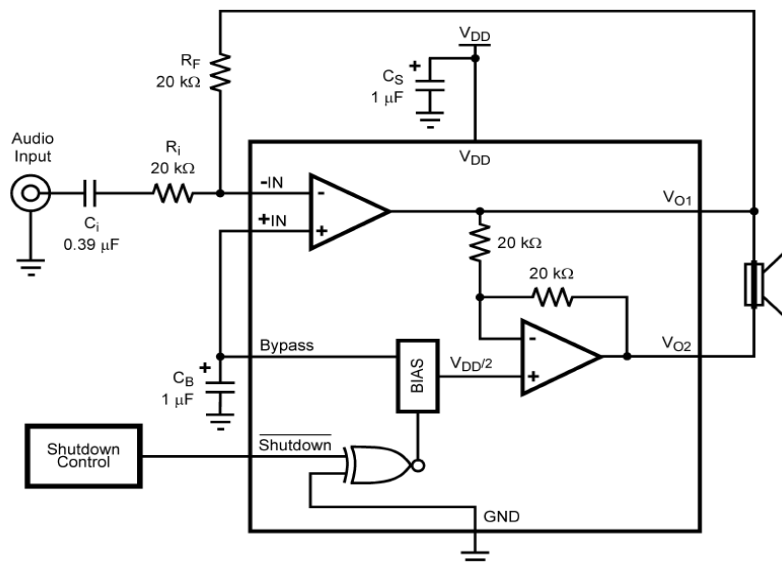
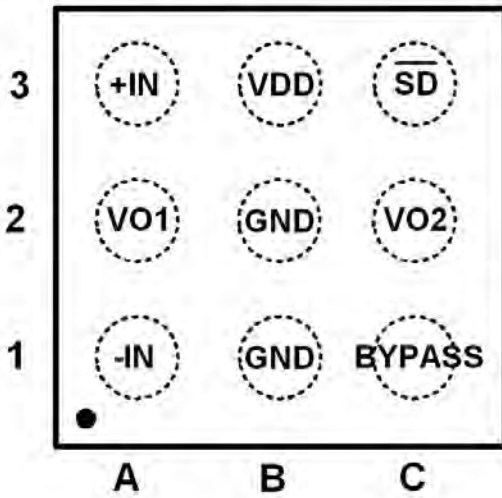

Figure 1: Typical Audio Amplifier Application Circuit

PIN CONFIGURATION AND DESCRIPTION

Top View



ft690A
QFN1.5X1.5-9L

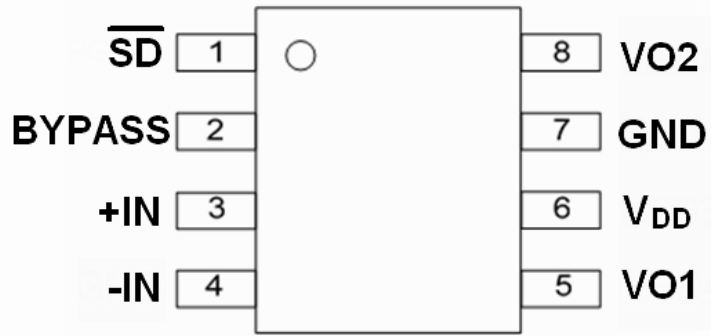

ft690M
MSOP-8L

| SYMBOL | QFN9 | MSOP8 | DESCRIPTION |
|-----------------|---------|-------|---|
| V _{DD} | B3 | 6 | Power supply |
| \overline{SD} | C3 | 1 | Active low shutdown control |
| -IN | A1 | 4 | Negative differential input |
| +IN | A3 | 3 | Positive differential input |
| VO1 | A2 | 5 | Negative BTL output |
| VO2 | C2 | 8 | Positive BTL output |
| BYPASS | C1 | 2 | Bypass capacitor pin which provides the common mode voltage |
| GND | B1 & B2 | 7 | Ground |

ORDERING INFORMATION

| PART NUMBER | TEMPERATURE RANGE | PACKAGE | GAIN (dB) |
|-------------|-------------------|---------------|------------|
| ft690A | -40°C to +85°C | COL1.5X1.5-9L | Adjustable |
| ft690M | -40°C to +85°C | MSOP-8L | Adjustable |

ABSOLUTE MAXIMUM RATINGS

| PARAMETER | VALUE |
|--|--------------------|
| Supply voltage, VDD | -0.3V to 6.0V |
| All other pins | -0.3V to VDD+0.3V |
| Storage temperature | -65°C to +150°C |
| Power dissipation | Internally Limited |
| ESD ratings - Human Body Model (HBM) | 2000V |
| Junction temperature | 150°C |
| θ_{JC} | 56°C/W |
| θ_{JA} | 190°C/W |
| Maximum soldering temperature (@10 sec duration) | 260°C |

Note: Stresses beyond those listed under absolute maximum ratings may cause permanent damage to the device. These are stress ratings only, and functional operation of the device at these or any other conditions beyond those indicated under recommended operating conditions is not implied. Exposure to absolute-maximum-rated conditions for extended periods may affect device reliability.

RECOMMENDED OPERATING CONDITIONS

| PARAMETER | CONDITIONS | MIN | TYP | MAX | UNIT |
|--|------------|-----|-----|-----|------|
| Supply voltage, VDD | | 2.5 | | 5.5 | V |
| Operating free-air temperature, T _A | | -40 | | 85 | °C |
| Load impedance, Z _L | | 6.4 | 8 | | Ω |

ELECTRICAL CHARACTERISTICS

VDD=5V.

The following specifications apply for the circuit shown in Figure 1, unless otherwise specified. Limits apply for TA=25°C.

| SYMBOL | PARAMETER | CONDITIONS | MIN | TYP | MAX | UNIT |
|-------------------|---------------------------------|--|-----|------|-----|------|
| I _{DD} | Quiescent current | V _{IN} =0V, I _O =0A, No Load | | 2.5 | 5 | mA |
| | | V _{IN} =0V, I _O =0A, 8Ω Load | | 3 | 7 | mA |
| I _{SD} | Shutdown current | V _{SD} = 0 | | 0.1 | 2.0 | μA |
| V _{OS} | Output offset voltage | | | 7 | 50 | mV |
| V _{SDIH} | SD pin HIGH input voltage | | 1.5 | | | V |
| V _{SDIL} | SD pin LOW input voltage | | | | 0.5 | V |
| R _{OUT} | Resistor output to GND | | | 16 | | kΩ |
| P _O | Output power (8Ω) | THD+N=1%, f=1KHz | 0.9 | 1.25 | | W |
| T _{WU} | Wake-up time | C _B =1uF | | 130 | | ms |
| THD+N | Total Harmonic Distortion+Noise | P _O = 0.5Wrms; f=1KHz | | 0.2 | | % |
| PSRR | Power Supply Rejection Ratio | V _{ripple} =200mV sine p-p Input grounded, f=217HZ | 55 | 66 | | dB |
| | | V _{ripple} =200mV sine p-p Input grounded, f=1KHz | 55 | 76 | | |

VDD=3V.

The following specifications apply for the circuit shown in Figure 1, unless otherwise specified. Limits apply for TA=25°C.

| SYMBOL | PARAMETER | CONDITIONS | MIN | TYP | MAX | UNIT |
|-------------------|---------------------------------|--|-----|------|-----|------|
| I _{DD} | Quiescent current | V _{IN} =0V, I _O =0A, No Load | | 1.6 | 4 | mA |
| | | V _{IN} =0V, I _O =0A, 8Ω Load | | 2 | 5 | mA |
| I _{SD} | Shutdown current | V _{SD} = 0 | | 0.1 | 2.0 | μA |
| V _{OS} | Output offset voltage | | | 7 | 50 | mV |
| V _{SDIH} | SD pin HIGH input voltage | | 1.3 | | | V |
| V _{SDIL} | SD pin LOW input voltage | | | | 0.4 | V |
| R _{OUT} | Resistor output to GND | | | 16 | | KΩ |
| P _O | Output power (8Ω) | THD+N=1%, f=1KHz | | 425 | | mW |
| T _{WU} | Wake-up time | C _B =1uF | | 130 | | ms |
| THD+N | Total Harmonic Distortion+Noise | P _O = 0.25Wrms; f=1KHz | | 0.16 | | % |
| PSRR | Power Supply Rejection Ratio | V _{ripple} =200mV sine p-p Input grounded, f=217Hz | 55 | 66 | | dB |
| | | V _{ripple} =200mV sine p-p Input grounded, f=1KHz | 55 | 76 | | |

TYPICAL PERFORMANCE CHARACTERISTICS

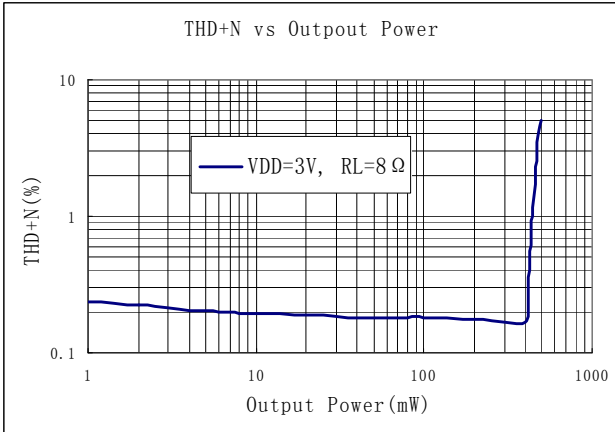

Figure 2

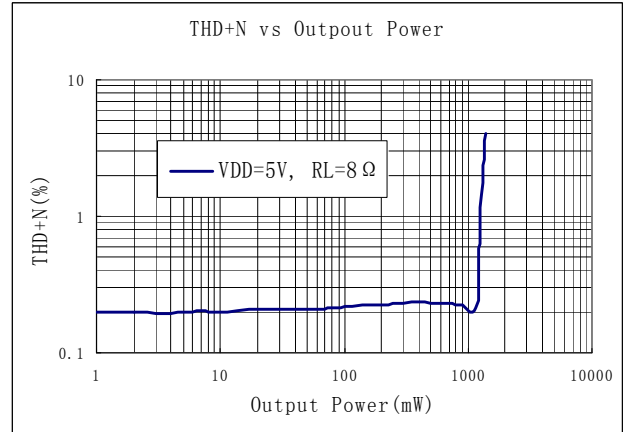

Figure 3

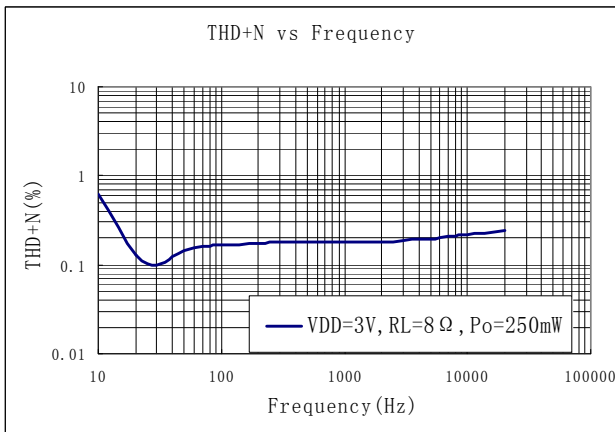

Figure 4

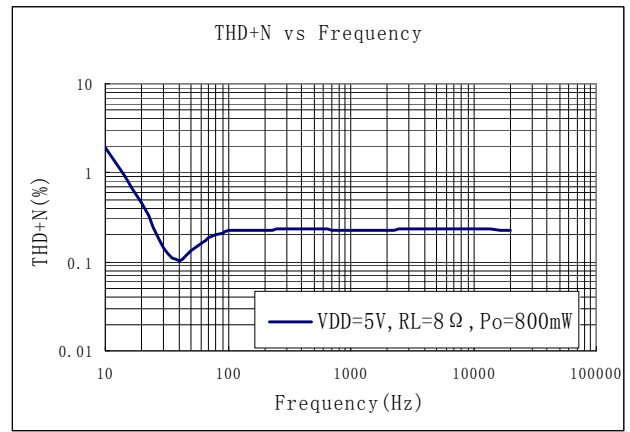

Figure 5

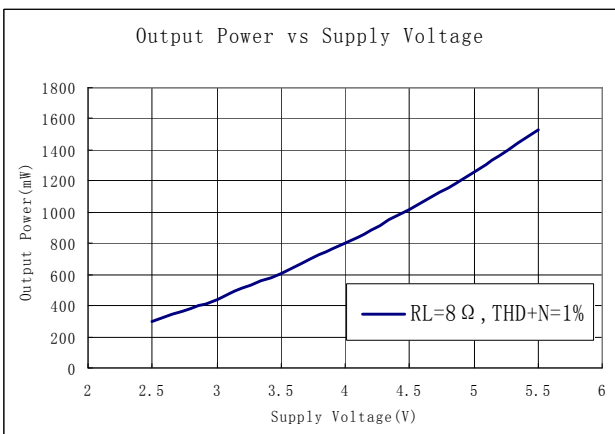

Figure 6

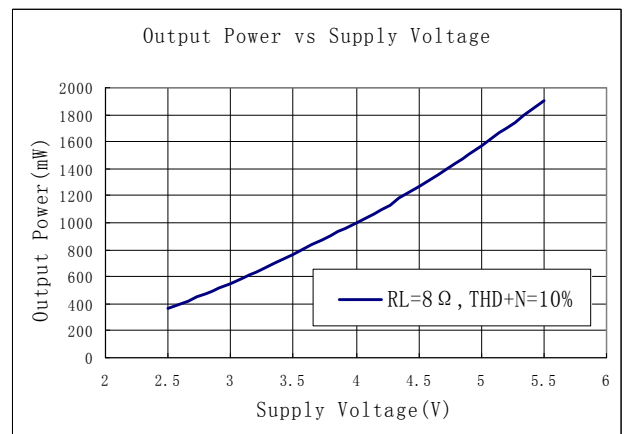

Figure 7

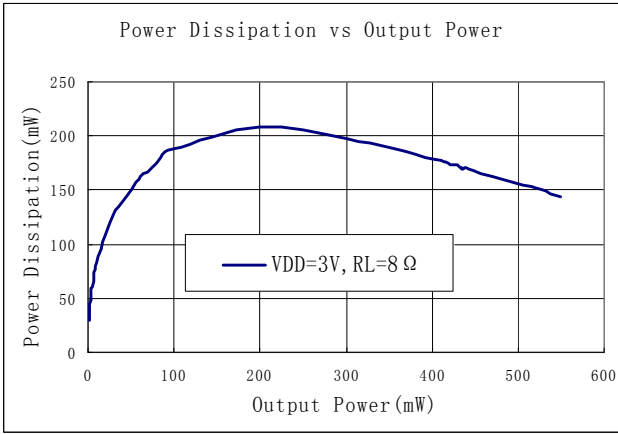

Figure 8

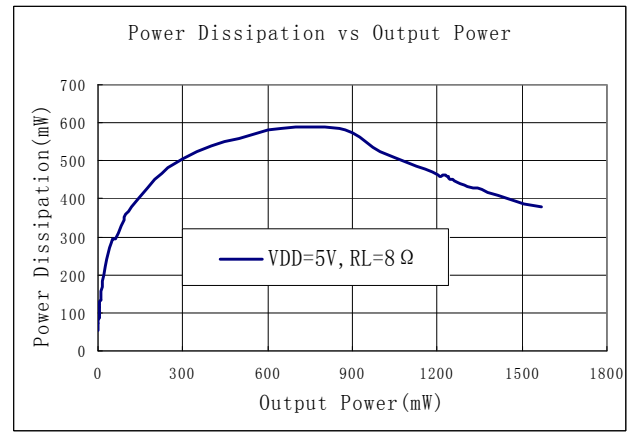

Figure 9

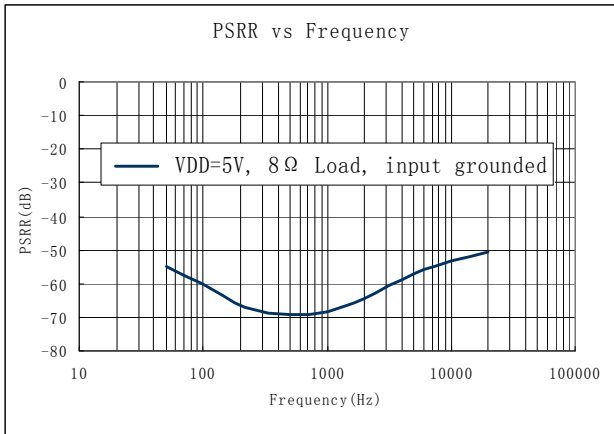

Figure 10

APPLICATION INFORMATION

BRIDGE CONFIGURATION EXPLANATION

As shown in Figure 1, the ft690 has two internal operational amplifiers. The first amplifier's gain is externally configurable, while the second amplifier is internally fixed in a unity-gain, inverting configuration. The closed-loop gain of the first amplifier is set by selecting the ratio of R_F to R_I while the second amplifier's gain is fixed by the two internal 20k Ω resistors. Figure 1 shows that the output of amplifier one serves as the input to amplifier two which results in both amplifiers producing signals identical in magnitude, but out of phase by 180°. Consequently, the differential gain for the IC is

$$A_{VD} = 2 * (R_F / R_I)$$

By driving the load differentially through outputs Vo1 and Vo2, an amplifier configuration commonly referred to as “bridged mode” is established. Bridged mode operation is different from the classical single-ended amplifier configuration where one side of the load is connected to ground.

A bridge amplifier design has a few distinct advantages over the single-ended configuration, as it provides differential drive to the load, thus doubling output swing for a specified supply voltage. Four times the output power is possible as compared to a single-ended amplifier under the same conditions. This increase in attainable output power assumes that the amplifier is not current limited or clipped. In order to choose an amplifier's closed-loop gain without causing excessive clipping, please refer to the [Audio Power Amplifier Design](#) section.

A bridge configuration, such as the one used in ft690, also creates a second advantage over single-ended amplifiers. Since the differential outputs, Vo1 and Vo2, are biased at half-supply, no net DC voltage exists across the load. This eliminates the need for an output coupling capacitor which is required in a single supply, single-ended amplifier configuration. Without an output coupling capacitor, the half-supply bias across the load would result in both increased internal IC power dissipation and also possible loudspeaker damage.

POWER DISSIPATION

Power dissipation is a major concern when designing a successful amplifier, whether the amplifier is bridged or single-ended. A direct consequence of the increased power delivered to the load by a bridge amplifier is an increase in internal power dissipation. Since the ft690 has two operational amplifiers in one package, the maximum internal power dissipation is 4 times that of a single-ended amplifier. The maximum power dissipation for a given application can be derived from the power dissipation graphs or from Equation 1.

$$P_{D_{MAX}} = 4 * (V_{DD})^2 / (2\pi^2 R_L) \quad (1)$$

It is critical that the maximum junction temperature $T_{J_{MAX}}$ of 150°C is not exceeded. $T_{J_{MAX}}$ can be determined from the power derating curves by using $P_{D_{MAX}}$ and the PC board foil area. By adding copper foil, the thermal resistance of the application can be reduced from the free air value of θ_{JA} , resulting in higher $P_{D_{MAX}}$ values without thermal shutdown protection circuitry being activated. Additional copper foil can be added to any of the leads connected to the ft690. It is especially effective when connected to V_{DD} , GND, and the output pins. Refer to the application information on the ft690 reference design board for an example of good heat sinking. If $T_{J_{MAX}}$ still exceeds 150°C, then additional changes must be made. These changes can include reduced supply voltage, higher load impedance, or reduced ambient temperature. Internal power dissipation is a function of output power.

POWER SUPPLY BYPASSING

As with any amplifier, proper supply bypassing is critical for low noise performance and high power supply rejection. The capacitor location on both the bypass and power supply pins should be as close to the device as possible. Typical applications employ a 5V regulator with 10 μ F tantalum or electrolytic capacitor and a ceramic bypass capacitor which aid in supply stability. This does not eliminate the need for bypassing the supply nodes of the ft690. The selection of a bypass capacitor, especially C_B , is dependent upon various design considerations such as PSRR requirements, pop and click performance, system cost, and size constraints.

SHUTDOWN FUNCTION

In order to reduce power consumption while not in use, the ft690 contains shutdown circuitry. This shutdown turns the amplifier off when logic low is placed on the SD pin. By asserting the shutdown pin to GND, the ft690 supply current draw will be minimized in idle mode.

In many applications, a microcontroller or microprocessor output is used to control the shutdown circuitry, which provides a quick, smooth transition to shutdown. Another solution is to use a single-throw switch in conjunction with an external pull-down resistor. This scheme guarantees that the shutdown pin will not float, thus preventing unwanted state changes.

PROPER SELECTION OF EXTERNAL COMPONENTS

Proper selection of external components in applications using integrated power amplifiers is critical to optimize device and system performance. While the ft690 is tolerant of external component combinations, consideration to component values must be used to maximize overall system quality.

The ft690 is unity-gain stable which gives the designer maximum system flexibility. The ft690 should be used in low gain configurations to minimize THD+N values, and maximize the signal to noise ratio. Low gain configurations require large input signals to obtain a given output power. Input signals equal to or greater than 1V_{rms} are available from sources such as audio codec. Besides gain, one of the major considerations is the closed loop bandwidth of the amplifier. To a large extent, the bandwidth is dictated by the choice of external components shown in Figure 1. The input coupling capacitor, C_I , forms a first order high pass filter which limits low frequency response. This value should be chosen based on needed frequency response for a few distinct reasons.

SELECTION OF INPUT CAPACITOR SIZE

Large input capacitors are both expensive and space hungry for portable designs. Clearly, a certain sized capacitor is needed to couple in low frequencies without severe attenuation. But in many cases the speakers used in portable systems, whether internal or external, have little ability to reproduce signals below 100Hz to 150Hz. Thus, using a large input capacitor may not increase actual system performance.

In addition to system cost and size, pop and click performance is also affected by the size of the input coupling capacitor, C_I . A larger input coupling capacitor requires more charge to reach its quiescent DC voltage (nominally 1/2 V_{DD}). This charge comes from the output via the feedback and is apt to create pops upon device enable. Thus, by minimizing the capacitor size based on necessary low frequency response, turn-on pops can be minimized.

Besides minimizing the input capacitor size, careful consideration should be paid to the bypass capacitor value. Bypass capacitor, C_B , is the most critical component to minimize turn-on pops since it determines how fast the ft690 turns on. The slower the ft690's outputs ramp to their quiescent DC voltage (nominally 1/2 V_{DD}), the

smaller the turn-on pops. Choosing C_B equal to $1.0\mu\text{F}$ along with a small value of C_I (in the range of $0.1\mu\text{F}$ to $0.39\mu\text{F}$), should produce a virtually click-less and pop-less shutdown function. While the device will function properly with C_B equal to $0.1\mu\text{F}$, the device will be much more susceptible to turn-on pops and clicks. Thus, a value of C_B equal to $1.0\mu\text{F}$ is recommended in all but the most cost sensitive designs.

AUDIO POWER AMPLIFIER DESIGN EXAMPLE

A 1W/8Ω Audio Amplifier

Given that

| | |
|------------------|------------------------|
| Power Output: | 1Wrms |
| Load Impedance: | 8Ω |
| Input Level: | 1Vrms |
| Input Impedance: | 20kΩ |
| Bandwidth: | 100Hz – 20kHz ± 0.25dB |

A designer must first determine the minimum supply rail to obtain the specified output power. By extrapolating from the Output Power VS Supply Voltage graphs in the **Typical Performance Characteristics** section, the supply rail can be easily found.

5V is a standard voltage in most applications, it is chosen for the supply rail. Extra supply voltage creates headroom that allows the ft690 to reproduce peaks in excess of 1W without producing audible distortion. At this time, the designer must make sure that the power supply choice along with the output impedance does not violate the conditions explained in the Power Dissipation section.

Once the power dissipation equations have been addressed, the required differential gain can be determined from Equation 2.

$$A_{VD} \geq \sqrt{(P_o R_L) / (V_{IN})} = V_{ORMS} / V_{IRMS} \quad (2)$$

$$R_F / R_I = A_{VD} / 2$$

From Equation 2, the minimum A_{VD} is 2.83; use $A_{VD} = 3$. Since the desired input impedance was $20\text{k}\Omega$, and with a A_{VD} impedance of 2, a ratio of 1.5:1 of R_F to R_I results in an allocation of $R_I = 20\text{k}\Omega$ and $R_F = 30\text{k}\Omega$. The final design step is to address the bandwidth requirements which must be stated as a pair of -3dB frequency points. Five times away from a -3dB point is 0.17dB down from passband response which is better than the required $\pm 0.25\text{dB}$ specified.

$$f_L = 100\text{Hz} / 5 = 20\text{Hz}$$

$$f_H = 20\text{kHz} * 5 = 100\text{kHz}$$

R_I in conjunction with C_I creating a high-pass filter

$$C_I \geq 1 / (2\pi * 20\text{k}\Omega * 20\text{Hz}) = 0.397\mu\text{F}; \text{ use } 0.39\mu\text{F}$$

The high frequency pole is determined by the product of the desired frequency pole, f_H , and the differential gain, A_{VD} . With a $A_{VD} = 3$ and $f_H = 100\text{kHz}$, the resulting GBWP = 300kHz which is much smaller than the ft690 GBWP of 2.5MHz . This figure displays that if a designer has a need to design an amplifier with a higher differential gain, the ft690 can still be used without running into bandwidth limitations.

The ft690 is unity-gain stable and requires no external components besides gain-setting resistors, an input

coupling capacitor, and proper supply bypassing in the typical application. However, if a closed-loop differential gain of greater than 10 is required, a feedback capacitor (C_4) may be needed as shown in Figure 11 to bandwidth limit the amplifier. This feedback capacitor creates a low pass filter that eliminates possible high frequency oscillations. Care should be taken when calculating the -3dB frequency in that an incorrect combination of R_3 and C_4 will cause a roll-off lower than 20kHz. A typical combination of feedback resistor and capacitor that will not produce audio band high frequency roll off is $R_3 = 20k\Omega$ and $C_4 = 25pf$. These components result in a -3dB point of approximately 320kHz.

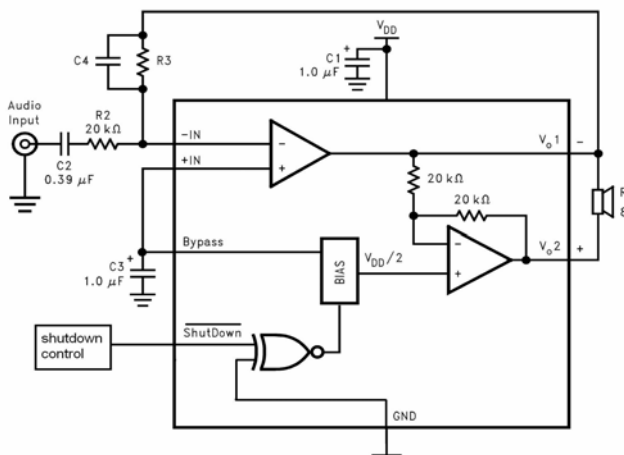

Figure 11: High Gain Audio Amplifier

Differential Input Application

The schematic in Figure 12 shows how to design the ft690 to work in a differential input mode.

The gain of the amplifier is:

$$A_{VD} = 2 * (R_3/R_2), \text{ Given that } R_2=R_5, R_3=R_6$$

In order to reach the optimal performance of the differential function, R_2 and R_5 , or R_3 and R_6 should be matched at 1% max.

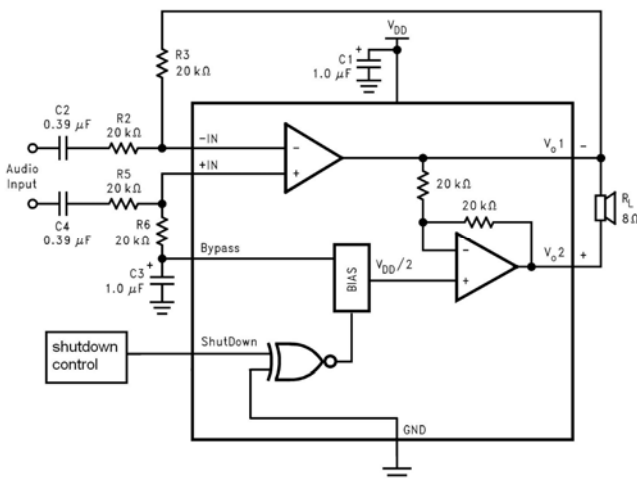
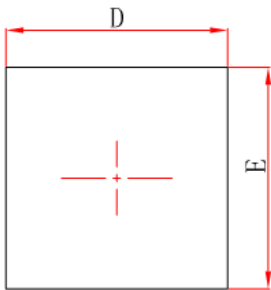

Figure 12: Differential Amplifier Configuration For ft690

PHYSICAL DIMENSIONS

ft690A --COL1.5X1.5-9L (P0.50T0.50/0.60) PACKAGE OUTLINE DIMENSIONS



Top View

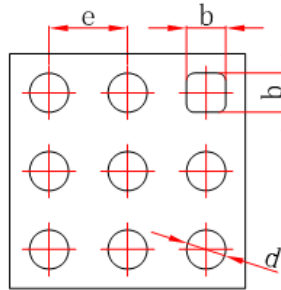

Bottom View

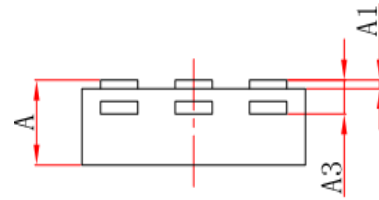

Side View

| Symbol | Dimensions in Millimeters | | Dimensions in Inches | |
|-----------|---------------------------|-------------|----------------------|-------------|
| | Min. | Max. | Min. | Max. |
| A | 0.450/0.550 | 0.550/0.650 | 0.018/0.022 | 0.022/0.026 |
| A1 | 0.000 | 0.050 | 0.000 | 0.002 |
| A3 | 0.152REF | | 0.006REF | |
| D | 1.424 | 1.576 | 0.056 | 0.062 |
| E | 1.424 | 1.576 | 0.056 | 0.062 |
| D1 | - | - | - | - |
| E1 | - | - | - | - |
| k | - | | - | |
| b | 0.174 | 0.326 | 0.007 | 0.013 |
| e | 0.500TYP | | 0.020TYP | |
| l | - | - | - | - |
| d | 0.174 | 0.326 | 0.007 | 0.013 |

Unit: millimeters.

ft690M MSOP8 Package

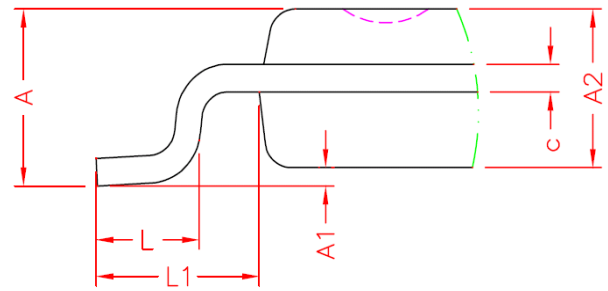
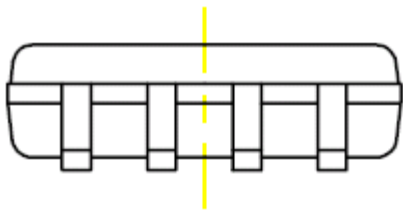
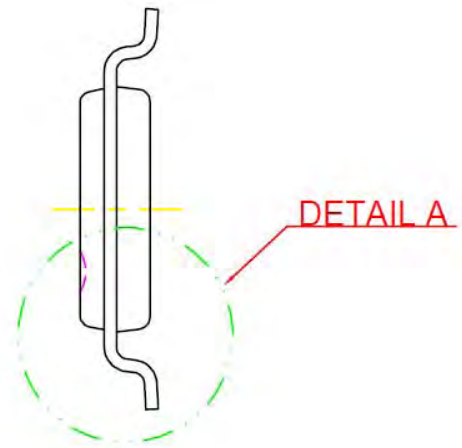
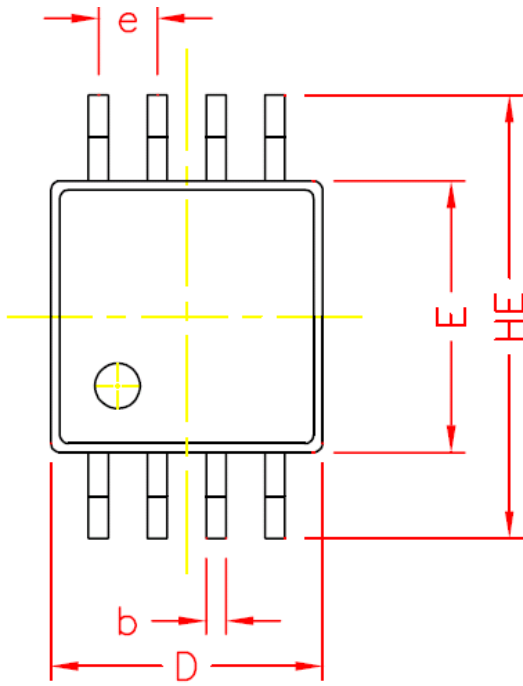

| REF | MIN | TYP | MAX |
|-----|------|------|------|
| A | -- | 1.10 | -- |
| A1 | 0.05 | 0.10 | 0.15 |
| A2 | 0.78 | 0.86 | 0.94 |
| D | 2.90 | 3.0 | 3.1 |
| E | 2.90 | 3.0 | 3.1 |
| HE | 4.75 | 4.9 | 5.05 |
| L | 0.4 | 0.55 | 0.7 |
| L1 | -- | 0.95 | -- |
| b | 0.22 | 0.30 | 0.38 |
| c | 0.08 | 0.15 | 0.23 |
| e | -- | 0.65 | -- |

Unit: millimeters.