

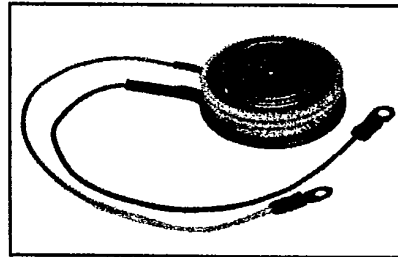

FT800DL

Powerex, Inc. Hillis Street, Youngwood, Pennsylvania 15697 (412) 925-7272
 Powerex Europe, S.A., 428 Ave. G. Durand, BP107, 72003 LeMans, France (43) 72.75.15

Phase Control SCR
800 Amperes Avg
200-1200 Volts

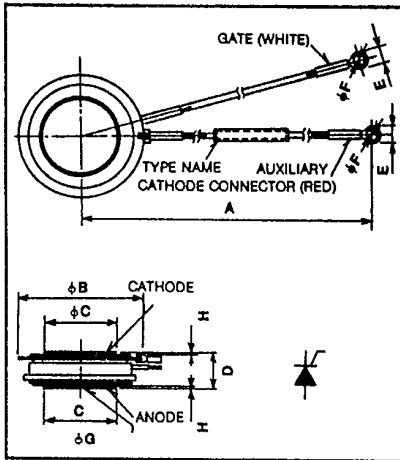

FT800DL
Phase Control SCR
 800 Amperes/200-1200 Volts

FT800DL
Outline Drawing

Dimensions	Inches	Metric
A	16.93 ± .40	430 ± 10
φB	2.362 Max	60 Max
φC	1.260	32
D	.57 ± .02	14.5 ± 0.5
E	.30	7.5
φF	.169	4.3
φG	.165	4.2
H	.015 Min	0.4 Min

¹Depth .08 in or 2mm

Description

Powerex Silicon Controlled Rectifiers (SCR) are designed for phase control applications. These are all-diffused, Press-Pak (Pow-R-Disc) devices employing the field proven amplifying (di/namic) gate.

Features:

- Low On-State Voltage
- High di/dt
- High dv/dt
- Hermetic Packaging
- Excellent Surge and I²t Ratings

Applications:

- Power Supplies
- Battery Chargers
- Motor Control
- Light Dimmers
- VAR Generators

Ordering Information

Example: Select the complete eight or nine digit part number you desire from the table - i.e. FT800DL-12 is a 600 Volt, 800 Ampere Phase Control SCR.

Type	Voltage*		Current
	V _{ONM} V _{RRM}	Code	
FT800DL	200	-4	800
	300	-6	
	400	-8	
	500	-10	
	600	-12	
	800	-16	
	1000	-20	
1200	-24		

*Voltage classes 8, 12, 16, and 24 are standard products.



Powerex, Inc., Hillis Street, Youngwood, Pennsylvania 15697 (412) 925-7272

Powerex Europe, S.A., 428 Ave. G. Durand, BP107, 72003 LeMans, France (43) 72.75.15

FT800DL

Phase Control SCR

800 Amperes Avg/200-1200 Volts

Absolute Maximum Ratings

	Symbol	FT800DL	Units
RMS On-State Current	$I_{T(RMS)}$	1250	Amperes
Average On-State Current	$I_{T(av)}$	800	Amperes
Peak One-Cycle Surge (Non Repetitive) On-State Current (60Hz)	I_{TSM}	14,000	Amperes
Peak One-Cycle Surge (Non-Repetitive) On-State Current (50Hz)	I_{TSM}	12,800	Amperes
Critical Rate-of-Rise of On-State Current (Non-Repetitive)	di/dt	500	Amperes/ μ s
Critical Rate-of-Rise of On-State Current (Repetitive)	di/dt	200	Amperes/ μ s
I^2t (for Fusing), one cycle at 60Hz	I^2t	8.2×10^5	A^2sec
Peak Gate Power Dissipation	P_{GM}	10	Watts
Average Gate Power Dissipation	$P_{G(av)}$	3	Watts
Storage Temperature	T_{STG}	-40 to 150	$^{\circ}C$
Operating Temperature	T_J	-40 to 125	$^{\circ}C$
Mounting Force [Ⓞ]		3000 to 4000	lb.
Mounting Force [Ⓞ]		1350 to 1800	kg

Electrical and Thermal Characteristics

Characteristics	Symbol	Test Conditions	FT800DL	Units
Voltage—Blocking State Maximums				
Forward Leakage, Peak	I_{ORM}	$T_J = 125^{\circ}C, V_{DRM}$ applied	30	mA
Reverse Leakage, Peak	I_{RRM}	$T_J = 125^{\circ}C, V_{RRM}$ applied	30	mA
Current—Conducting State Maximums				
Peak On-State Voltage	V_{TM}	$I_{TM} = 2500A$	1.50	Volts
Switching				
Min. Critical dv/dt exponential to V_{DRM}	dv/dt	$T_J = 125^{\circ}C, V_D = 1/2V_{DRM}$	200	V/ μ sec
Thermal				
Maximum Thermal Resistance, [Ⓞ] double sided cooling Junction to Sink	$R_{\theta JS}$.040	$^{\circ}C/Watt$
Gate—Maximum Parameters				
Gate Current to Trigger	I_{GT}	$V_D = 6V, T_J = 25^{\circ}C, R_L = 2\Omega$	250	mA
Gate Voltage to Trigger	V_{GT}	$V_D = 6V, T_J = 25^{\circ}C, R_L = 2\Omega$	2.5	Volts
Non-Triggering Gate Voltage	V_{GDM}	$T_J = 125^{\circ}C, V_D = 1/2V_{DRM}$.20	Volts
Peak Forward Gate Current	I_{GTM}		4	Amperes
Peak Reverse Gate Voltage	V_{GRM}		5	Volts

[Ⓞ] Consult recommended mounting procedures.



Powerex, Inc., Hillis Street, Youngwood, Pennsylvania 15697 (412) 925-7272
 Powerex Europe, S.A., 428 Ave. G. Durand, BP107, 72003 LeMans, France (43) 72.75.15

FT800DL
 Phase Control SCR
 800 Amperes Avg/200-1200 Volts

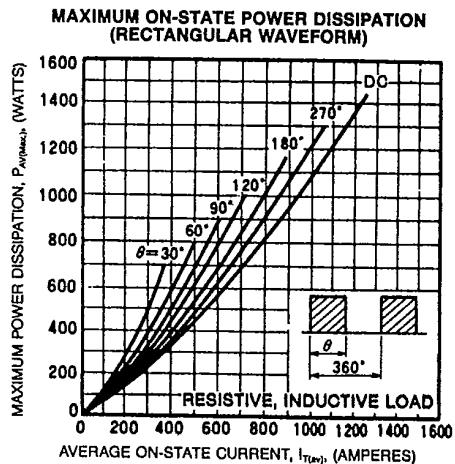
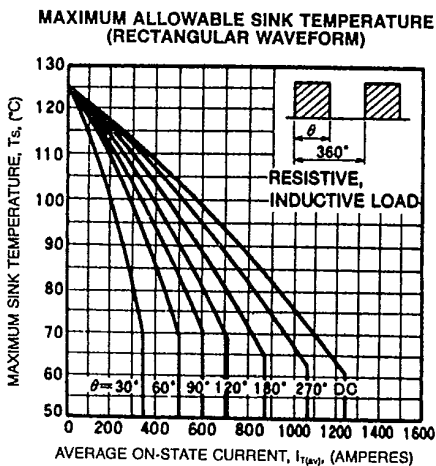
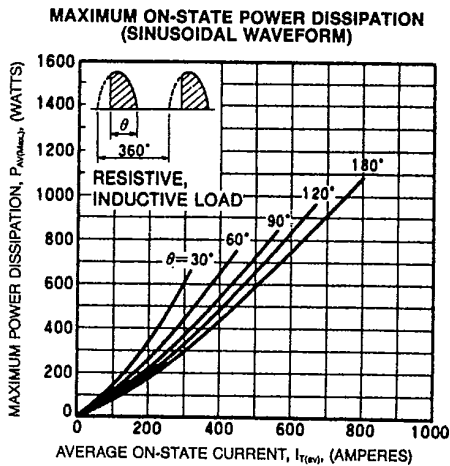
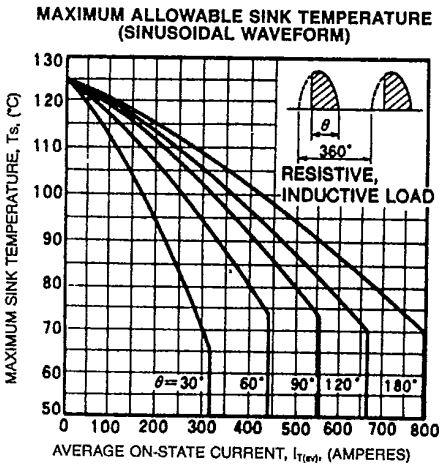
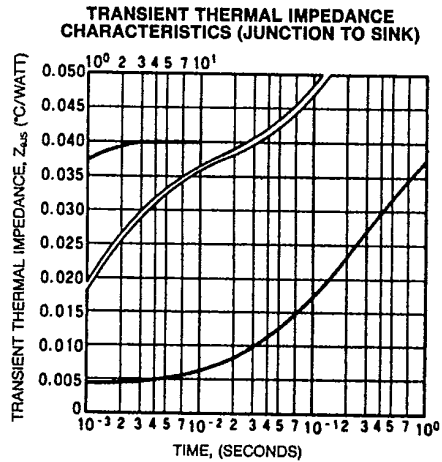
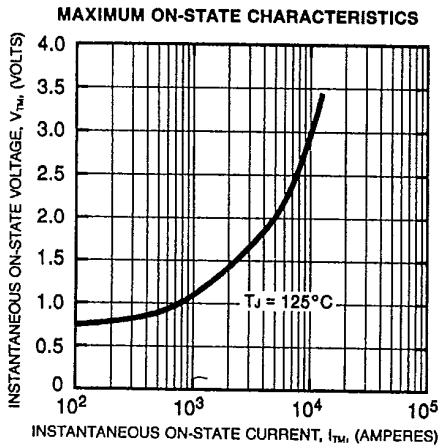



Powerex, Inc., Hills Street, Youngwood, Pennsylvania 15697 (412) 925-7272
 Powerex Europe, S.A., 428 Ave. G. Durand, BP107, 72003 LeMans, France (43) 72.75.15

FT800DL
 Phase Control SCR
 800 Amperes Avg/200-1200 Volts

MAXIMUM ALLOWABLE SURGE ON-STATE CURRENT (NON-REPETITIVE)

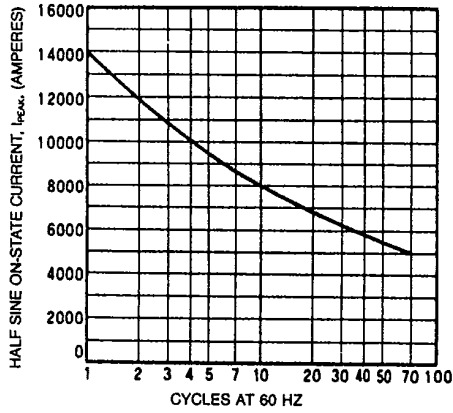

REVERSE RECOVERED CHARGE (TYPICAL)

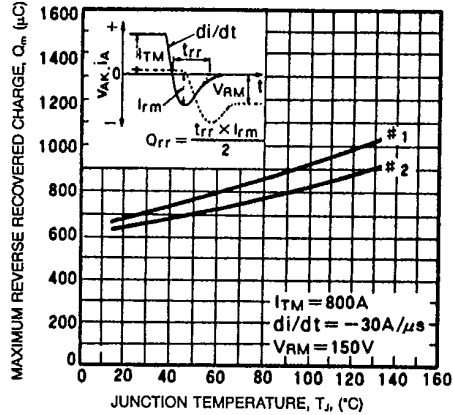

TURN-ON TIME VS. JUNCTION TEMPERATURE (TYPICAL)

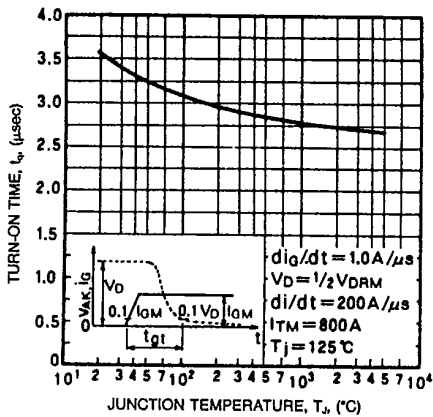

GATE CHARACTERISTICS

