

# 3-Phase Inverter Automotive Power Module

## FTCO3V455A1

### General Description

The FTCO3V455A1 is a 40 V low  $R_{DS(ON)}$  automotive qualified power module featuring a 3-phase MOSFET inverter optimized for 12 V battery systems. It includes a precision shunt resistor for current sensing an NTC for temperature sensing and an RC snubber circuit.

The module utilizes onsemi's trench MOSFET technology and it is designed to provide a very compact and high performance variable speed motor drive for applications like electric power steering, electro-hydraulic power steering, electric water pumps, electric oil pumps. The power module is 100% lead free, RoHS and UL compliant.

### Features

- 40 V – 150 A 3-phase Trench MOSFET Inverter Bridge
- 1% Precision Shunt Current Sensing
- Temperature Sensing
- DBC Substrate
- 100% Lead Free and RoHS Compliant with 2000/53/C Directive
- UL94V-0 Compliant
- Isolation Rating of 2500 V rms/min
- Mounting Through Screws
- Automotive Qualified

### Benefits

- Low Junction-sink Thermal Resistance
- Low Inverter Electrical Resistance
- High Current Handling
- Compact Motor Design
- Highly Integrated Compact Design
- Better EMC and Electrical Isolation
- Easy and Reliable Installation
- Improved Overall System Reliability

### Applications

- Electric and Electro-Hydraulic Power Steering
- Electric Water Pump
- Electric Oil Pump
- Electric Fan

### Flammability Information

- All Materials Present in the Power Module Meet UL Flammability Rating Class 94 V-0 or Higher

### Solder

- Solder Used is a Lead Free SnAgCu Alloy

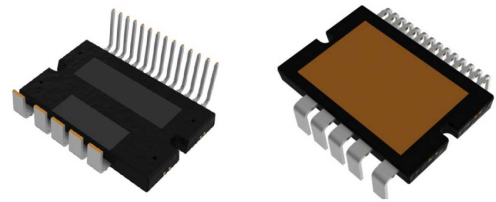

APMCB-A19  
CASE MODCG

### ELECTRICAL CONNECTION

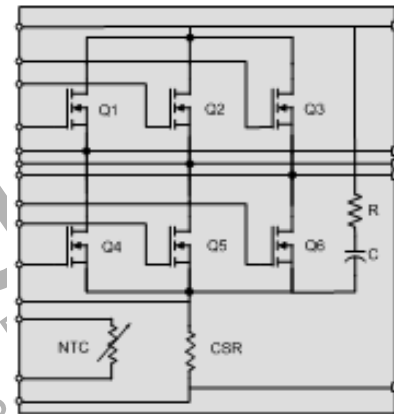

### MARKING DIAGRAM

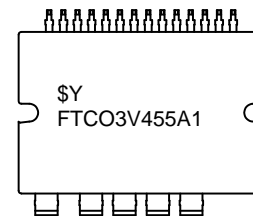

\$Y = ON Semiconductor  
FTCO3V455A1 = Specific Device Code

### ORDERING INFORMATION

See detailed ordering and shipping information on page 8 of this data sheet.

# FTCO3V455A1

## ABSOLUTE MAXIMUM RATINGS ( $T_J = 25^\circ\text{C}$ , Unless Otherwise Specified)

Symbol	Parameter	Rating	Unit
$V_{DS}(Q1-Q6)$	Drain to Source Voltage	40	V
$V_{GS}(Q1-Q6)$	Gate to Source Voltage	$\pm 20$	V
$I_D(Q1-Q6)$	Drain Current Continuous ( $T_C = 25^\circ\text{C}$ , $V_{GS} = 10\text{ V}$ )	150	A
$E_{AS}(Q1-Q6)$	Single Pulse Avalanche Energy (Note 1)	947	mJ
$P_D$	Power Dissipation	115	W
$T_J$	Maximum Junction Temperature	175	$^\circ\text{C}$
$T_{STG}$	Storage Temperature	125	$^\circ\text{C}$

Stresses exceeding those listed in the Maximum Ratings table may damage the device. If any of these limits are exceeded, device functionality should not be assumed, damage may occur and reliability may be affected.

## THERMAL RESISTANCE

Symbol	Parameter	Min.	Typ.	Max.	Unit
$R_{thjc}$ Thermal Resistance Junction to case, Single Inverter FET, chip center (Note 2)	Q1 Thermal Resistance J – C	–	0.8	1.1	$^\circ\text{C/W}$
	Q2 Thermal Resistance J – C	–	0.8	1.1	$^\circ\text{C/W}$
	Q3 Thermal Resistance J – C	–	0.8	1.1	$^\circ\text{C/W}$
	Q4 Thermal Resistance J – C	–	0.8	1.1	$^\circ\text{C/W}$
	Q5 Thermal Resistance J – C	–	0.8	1.1	$^\circ\text{C/W}$
	Q6 Thermal Resistance J – C	–	0.8	1.1	$^\circ\text{C/W}$
$T_J$	Maximum Junction Temperature	–		175	$^\circ\text{C}$
$T_S$	Operating Sink Temperature	–40		120	$^\circ\text{C}$
$T_{STG}$	Storage Temperature	–40		125	$^\circ\text{C}$

1. Starting  $T_J = 25^\circ\text{C}$ ,  $V_{DS} = 20\text{ V}$ ,  $I_{AS} = 64\text{ A}$ ,  $L = 480\ \mu\text{H}$ .

2. These values are based on Thermal simulations and PV level measurements.

These values assume a single MOSFET is on, and the test condition for referenced temperature is "Chip Center".

This means that the DT is measured between the  $T_J$  of each MOSFET and the temperature of the case located immediately under the center of the chip.

# FTCO3V455A1

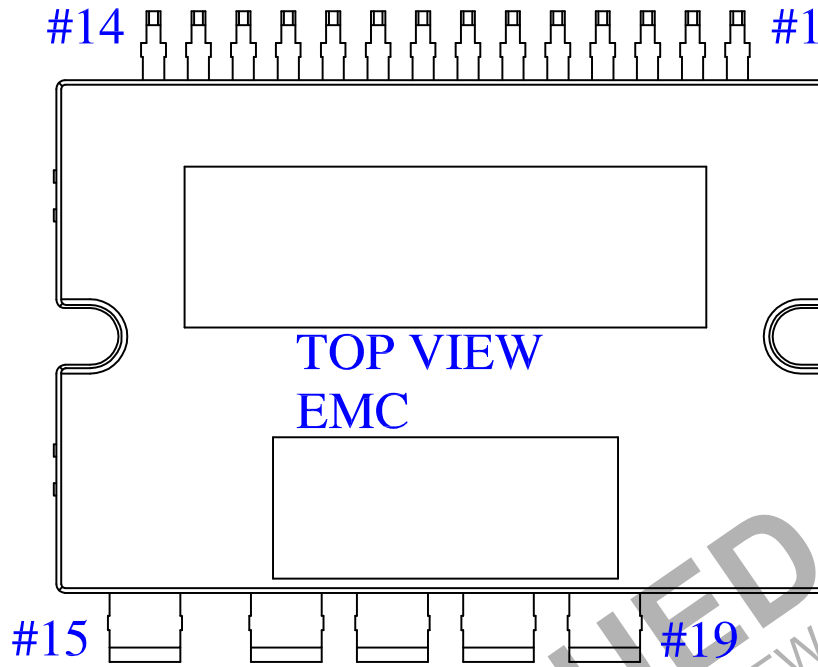

**Figure 1. Pin Configuration**

## PIN DESCRIPTION

Pin Number	Pin Name	Pin Descriptions
1	TEMP 1	NTC Thermistor Terminal 1
2	TEMP 2	NTC Thermistor Terminal 2
3	PHASE W SENSE	Source of HS W and Drain of LS W
4	GATE HS W	Gate of HS phase W MOSFET
5	GATE LS W	Gate of LS phase W MOSFET
6	PHASE V SENSE	Source of HS V and Drain of LS V
7	GATE HS V	Gate of HS phase V MOSFET
8	GATE LS V	Gate of LS phase V MOSFET
9	PHASE U SENSE	Source of HS U and Drain of LS U
10	GATE HS U	Gate of HS phase U MOSFET
11	VBAT SENSE	Drain of HS U, V and W MOSFET
12	GATE LS U	Gate of LS phase U MOSFET
13	SHUNT P	Source of LS U, V W MOSFETS / Shunt +
14	SHUNT N	Negative shunt terminal (shunt -)
15	VBAT	Positive battery terminal
16	GND	Negative battery terminal
17	PHASE U	Motor phase U
18	PHASE V	Motor phase V
19	PHASE W	Motor phase W

# FTCO3V455A1

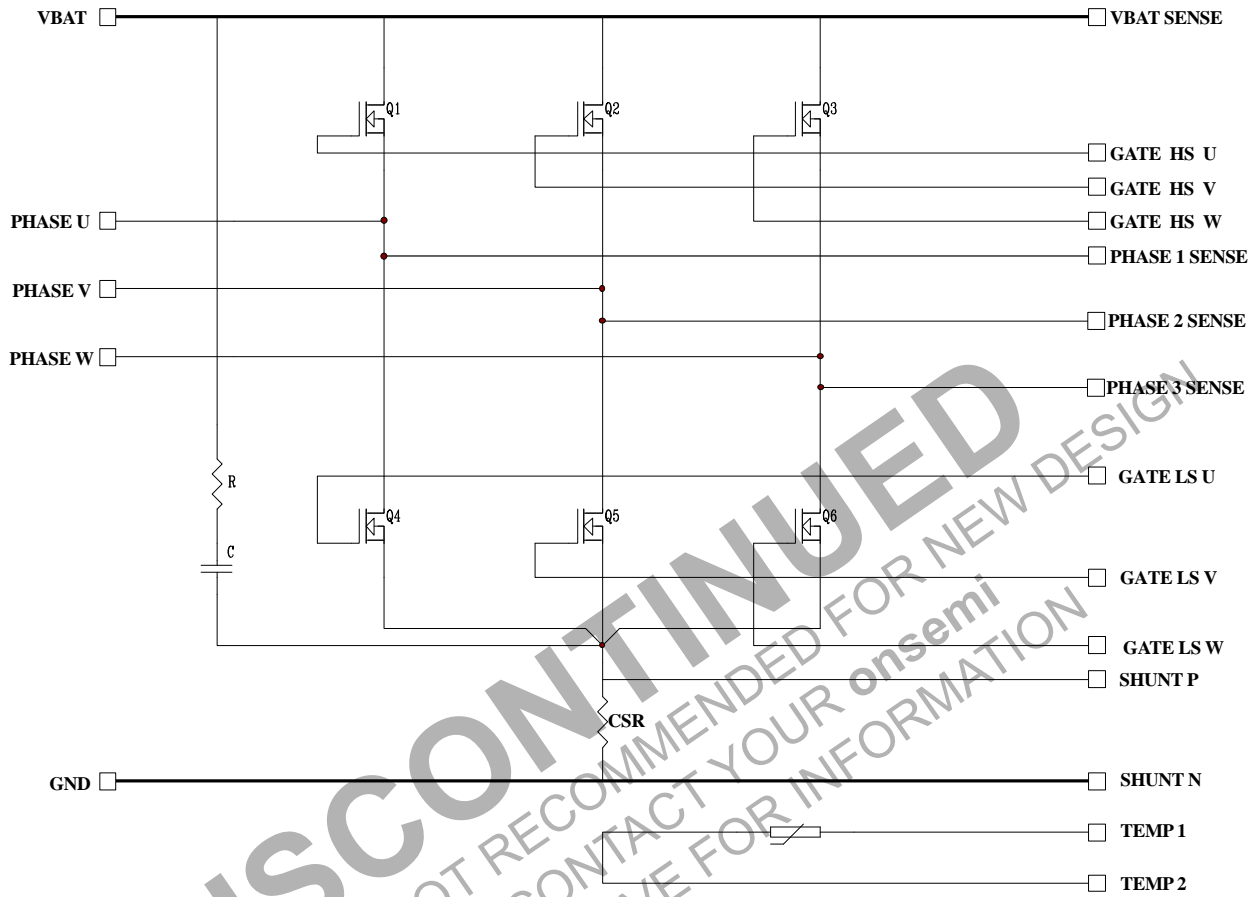

Figure 2. Internal Equivalent Circuit

# FTCO3V455A1

## ELECTRICAL CHARACTERISTICS (T<sub>J</sub> = 25°C, Unless Otherwise Specified)

Symbol	Parameter	Test Condition	Min	Typ	Max	Unit
BV <sub>DSS</sub>	D-S Breakdown Voltage (Inverter MOSFETs)	V <sub>GS</sub> = 0, I <sub>D</sub> = 250 μA	40	–	–	V
V <sub>GS</sub>	Gate to Source Voltage (Inverter MOSFETs)		–20	–	20	V
V <sub>TH</sub>	Threshold Voltage (Inverter MOSFETs)	V <sub>GS</sub> = V <sub>DS</sub> , I <sub>D</sub> = 250 μA, T <sub>J</sub> = 25°C	2.0	2.8	4.0	V
V <sub>SD</sub>	MOSFET Body Diode Forward Voltage	V <sub>GS</sub> = 0 V, I <sub>S</sub> = 80 A, T <sub>J</sub> = 25°C		0.8	1.28	V
R <sub>DS(ON)Q1</sub>	Inverter High Side MOSFETs Q1 (See Note 3)	V <sub>GS</sub> = 10 V, I <sub>D</sub> = 80 A, T <sub>J</sub> = 25°C	–	1.15	1.66	mΩ
R <sub>DS(ON)Q2</sub>	Inverter High Side MOSFETs Q2 (See Note 3)	V <sub>GS</sub> = 10 V, I <sub>D</sub> = 80 A, T <sub>J</sub> = 25°C	–	1.22	1.73	mΩ
R <sub>DS(ON)Q3</sub>	Inverter High Side MOSFETs Q3 (See Note 3)	V <sub>GS</sub> = 10 V, I <sub>D</sub> = 80 A, T <sub>J</sub> = 25°C	–	1.31	1.82	mΩ
R <sub>DS(ON)Q4</sub>	Inverter Low Side MOSFETs Q4 (See Note 3)	V <sub>GS</sub> = 10 V, I <sub>D</sub> = 80 A, T <sub>J</sub> = 25°C	–	1.36	1.87	mΩ
R <sub>DS(ON)Q5</sub>	Inverter Low Side MOSFETs Q5 (See Note 3)	V <sub>GS</sub> = 10 V, I <sub>D</sub> = 80 A, T <sub>J</sub> = 25°C	–	1.57	2.08	mΩ
R <sub>DS(ON)Q6</sub>	Inverter Low Side MOSFETs Q6 (See Note 3)	V <sub>GS</sub> = 10 V, I <sub>D</sub> = 80 A, T <sub>J</sub> = 25°C	–	1.86	2.32	mΩ
I <sub>DSS</sub>	Inverter MOSFETs (UH,UL,VH,VL,WH,WL)	V <sub>GS</sub> = 0 V, V <sub>DS</sub> = 32 V, T <sub>J</sub> = 25°C	–	–	1.0	μA
I <sub>GSS</sub>	Inverter MOSFETs Gate to Source Leakage Current	V <sub>GS</sub> = ±20 V	–	–	±100	nA
Total loop resistance VLINK(+) – V0 (–)		V <sub>GS</sub> = 10 V, I <sub>D</sub> = 80 A, T <sub>J</sub> = 25°C	–	4.69	5.5	mΩ

Product parametric performance is indicated in the Electrical Characteristics for the listed test conditions, unless otherwise noted. Product performance may not be indicated by the Electrical Characteristics if operated under different conditions.

3. All MOSFETs have same die size and R<sub>DS(ON)</sub>. The different R<sub>DS(ON)</sub> values listed in the datasheet are due to the different access points available inside the module for R<sub>DS(ON)</sub> measurement. While the high side MOSFETs (Q1, Q2, Q3) have source sense wire bonds, the low side MOSFETs (Q4, Q5, Q6) do not have source sense wire bonds, thus resulting in higher R<sub>DS(ON)</sub> values.

### TEMPERATURE SENSE (NTC Thermistor)

Symbol	Test Conditions	Test Time	Min	Typ	Max	Unit
Voltage	Current = 1 mA, Temperature = 25°C	T = 0.5 ms	7.5	–	12	V

### CURRENT SENSE RESISTOR

Symbol	Test Conditions	Test Time	Min	Typ	Max	Unit
Resistance	Current Sense resistor current = 80 A	T = 0.5 ms	0.46	–	0.53	mΩ

TYPICAL CHARACTERISTICS

(Generated using MOSFETs assembled in a TO263 package, for reference purposes only.)

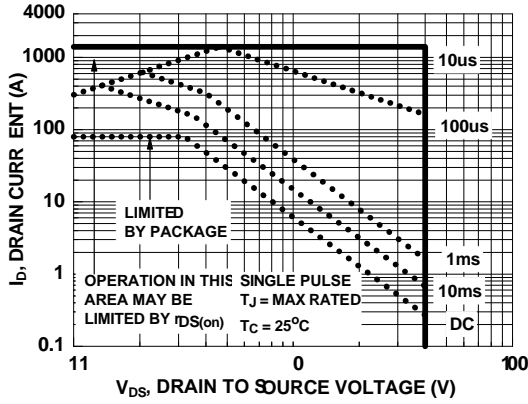
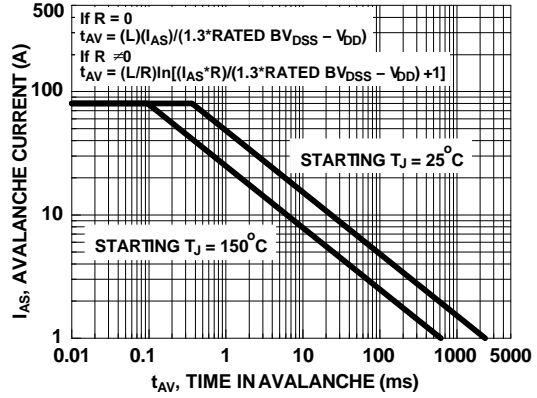

Figure 3. Forward Bias Safe Operating Area



NOTE: Refer to Application Notes AN7514 and AN7515

Figure 4. Unclamped Inductive Switching Capability

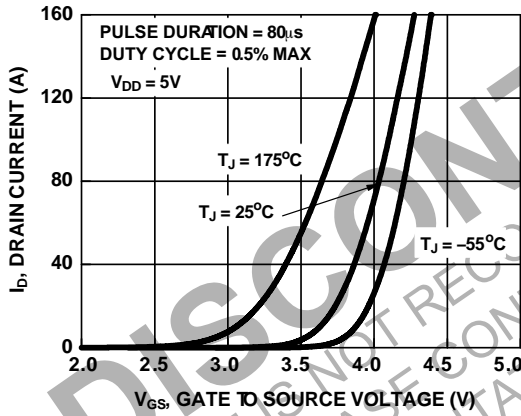

Figure 5. Transfer Characteristics

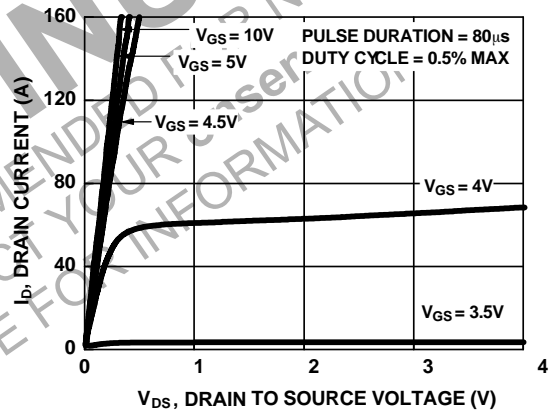

Figure 6. Saturation Characteristics

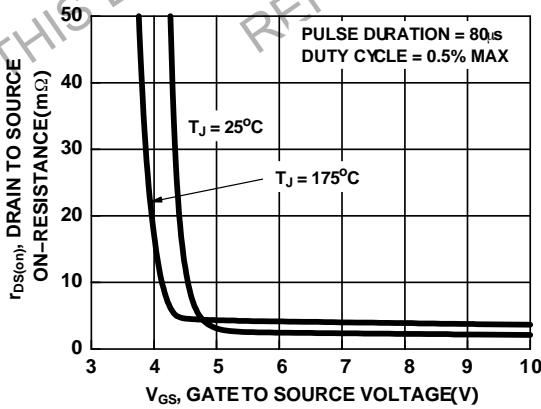

Figure 7. Drain to Source On-Resistance Variation vs Gate to Source Voltage

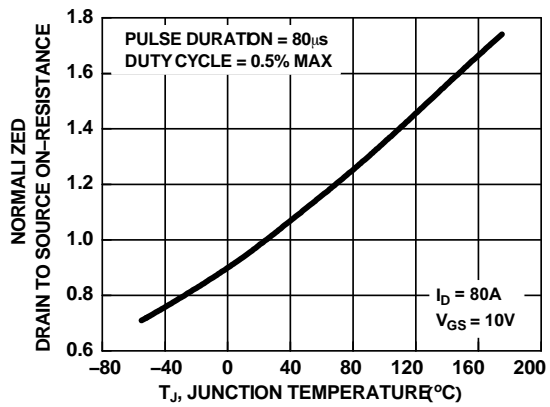

Figure 8. Normalized Drain to Source On Resistance vs Junction Temperature

TYPICAL CHARACTERISTICS

(Generated using MOSFETs assembled in a TO263 package, for reference purposes only.)

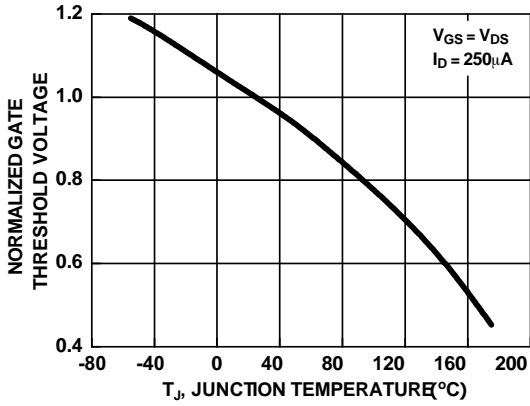

Figure 9. Normalized Gate Threshold Voltage vs Junction Temperature

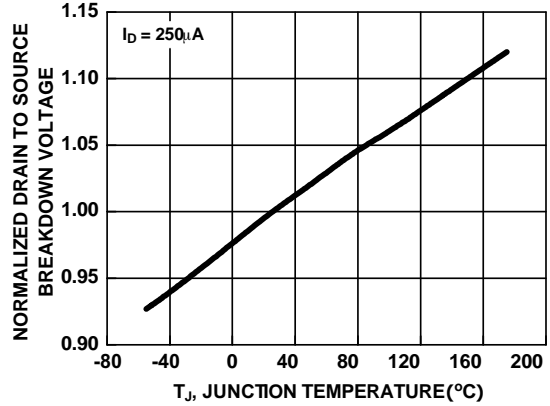

Figure 10. Normalized Drain to Source Breakdown Voltage vs Junction Temperature

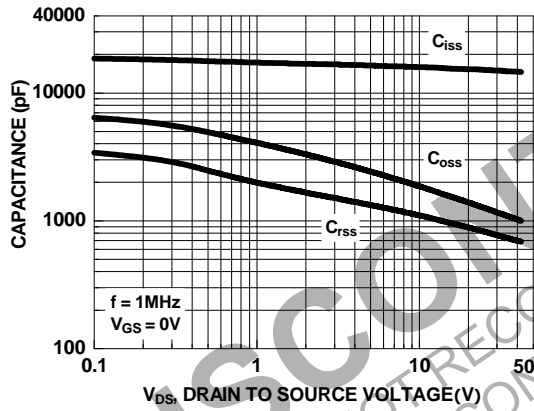

Figure 11. Capacitance vs Drain to Source Voltage

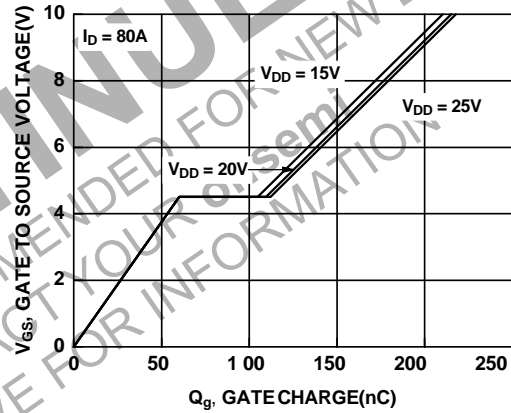
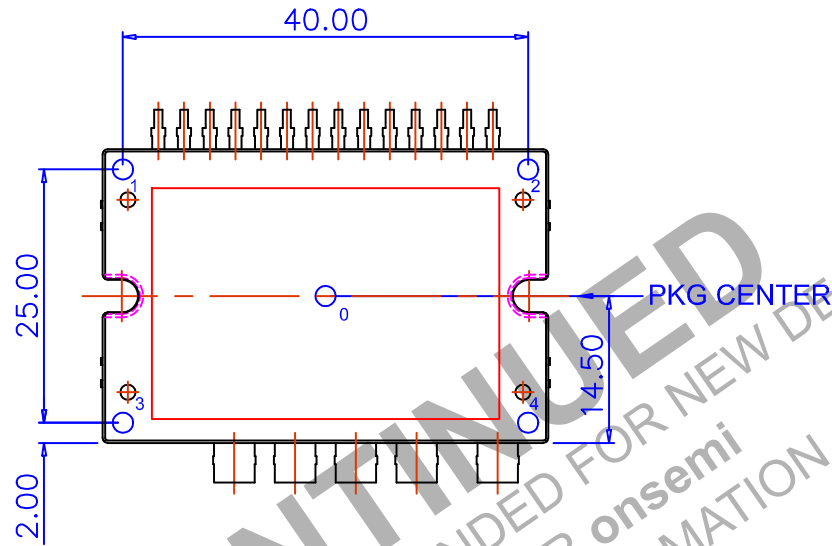

Figure 12. Gate Charge vs Gate to Source Voltage

# FTCO3V455A1

## MECHANICAL CHARACTERISTICS AND RATINGS

Parameter	Condition	Limits			Unit
		Min	Typ	Max	
Device Flatness	Note Figure 13.	0	-	+200	μm
Mounting Torque	Mounting Screw: - M3, Recommended 0.7 N.m	0.6	0.7	0.8	N.m
Weight		-	20	-	g



FLATNESS : MAX, 200μm

MEASURING AT INDICATING POINTS 1, 2, 3, AND 4 (BASED ON "0")

Figure 13. Flatness Measurement Position

## ORDERING INFORMATION

Device Marking	MOSFET	Packing Type	Quantity
FTCO3V455A1	PCF33478	Tube	11



# FTCO3V455A1

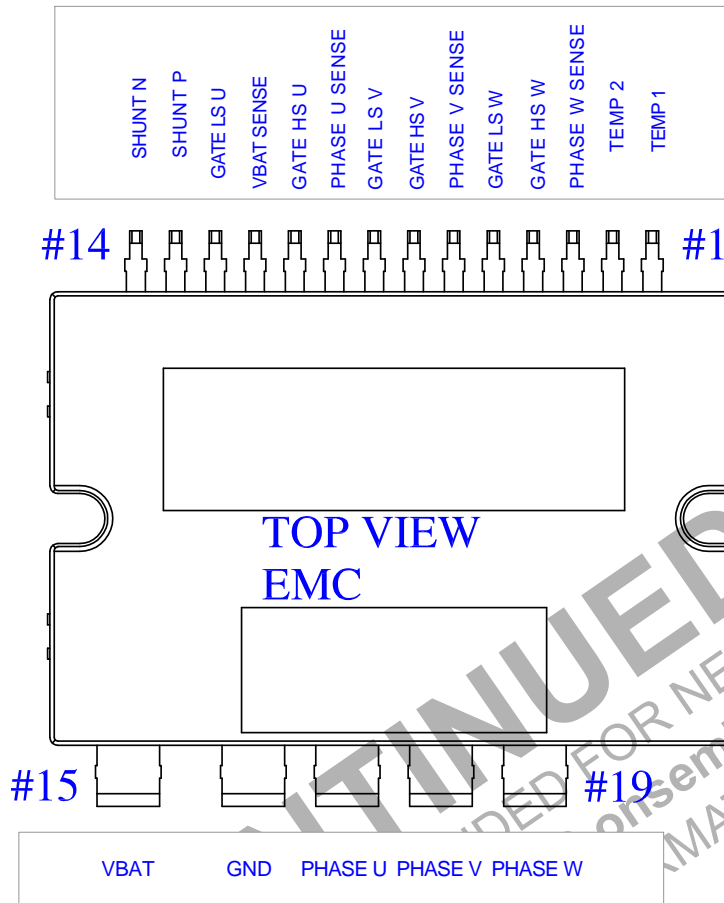

Figure 14.

DISCONTINUED  
THIS DEVICE IS NOT RECOMMENDED FOR NEW DESIGN  
PLEASE CONTACT YOUR ONSEMI REPRESENTATIVE FOR INFORMATION

# MECHANICAL CASE OUTLINE

## PACKAGE DIMENSIONS

ON Semiconductor®



### APMCB-A19 / 19LD, APM, PDD STD DBC, DIP TYPE CASE MODCG ISSUE O

DATE 31 DEC 2016

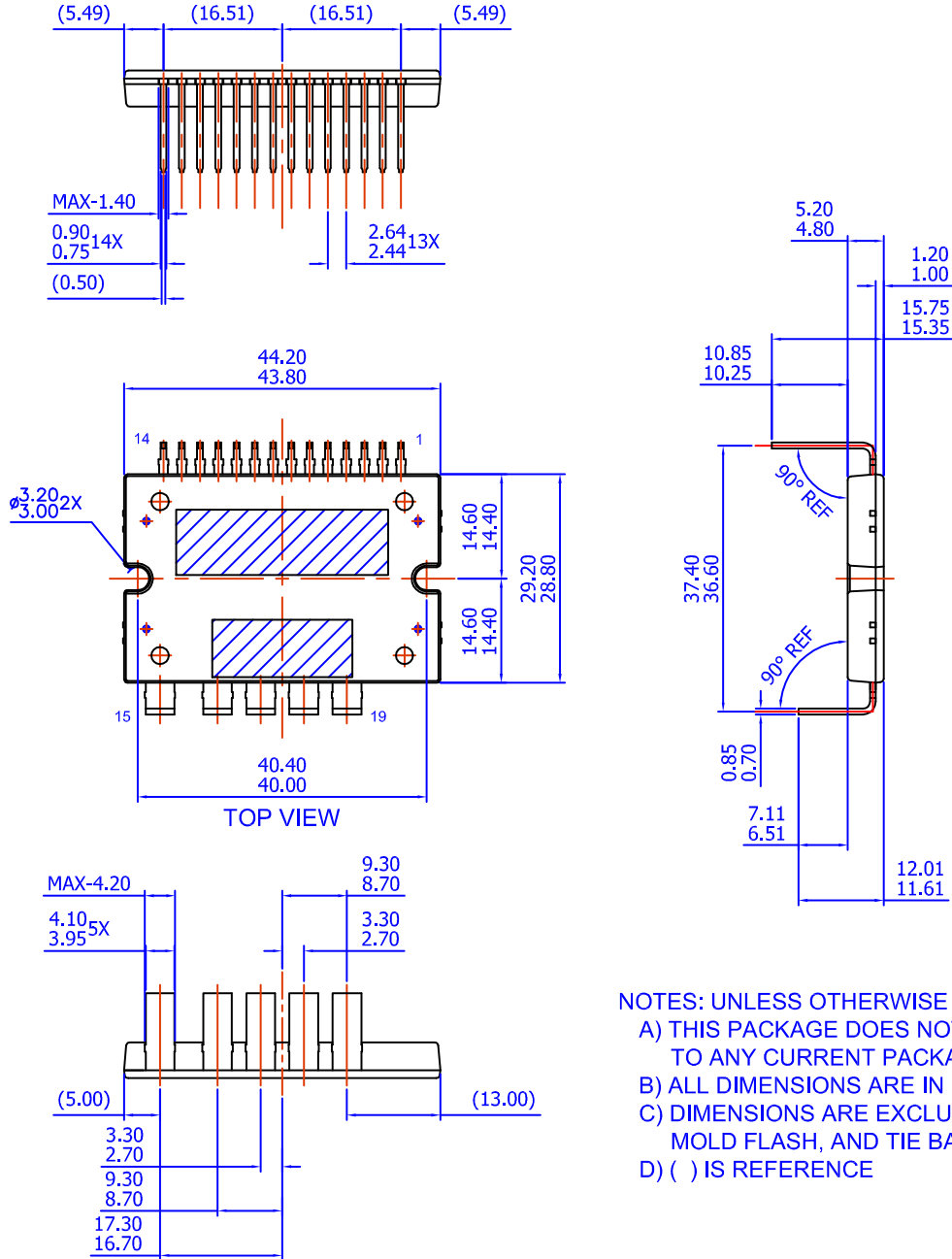

- NOTES: UNLESS OTHERWISE SPECIFIED
- A) THIS PACKAGE DOES NOT COMPLY TO ANY CURRENT PACKAGING STANDARD
  - B) ALL DIMENSIONS ARE IN MILLIMETERS
  - C) DIMENSIONS ARE EXCLUSIVE OF BURRS, MOLD FLASH, AND TIE BAR EXTRUSIONS
  - D) ( ) IS REFERENCE

<b>DOCUMENT NUMBER:</b>	<b>98AON13507G</b>	Electronic versions are uncontrolled except when accessed directly from the Document Repository. Printed versions are uncontrolled except when stamped "CONTROLLED COPY" in red.
<b>DESCRIPTION:</b>	<b>APMCB-A19 / 19LD, APM, PDD STD DBC, DIP TYPE</b>	<b>PAGE 1 OF 1</b>

ON Semiconductor and are trademarks of Semiconductor Components Industries, LLC dba ON Semiconductor or its subsidiaries in the United States and/or other countries. ON Semiconductor reserves the right to make changes without further notice to any products herein. ON Semiconductor makes no warranty, representation or guarantee regarding the suitability of its products for any particular purpose, nor does ON Semiconductor assume any liability arising out of the application or use of any product or circuit, and specifically disclaims any and all liability, including without limitation special, consequential or incidental damages. ON Semiconductor does not convey any license under its patent rights nor the rights of others.

**onsemi**, **Onsemi**, and other names, marks, and brands are registered and/or common law trademarks of Semiconductor Components Industries, LLC dba "**onsemi**" or its affiliates and/or subsidiaries in the United States and/or other countries. **onsemi** owns the rights to a number of patents, trademarks, copyrights, trade secrets, and other intellectual property. A listing of **onsemi**'s product/patent coverage may be accessed at [www.onsemi.com/site/pdf/Patent-Marking.pdf](http://www.onsemi.com/site/pdf/Patent-Marking.pdf). **onsemi** reserves the right to make changes at any time to any products or information herein, without notice. The information herein is provided "as-is" and **onsemi** makes no warranty, representation or guarantee regarding the accuracy of the information, product features, availability, functionality, or suitability of its products for any particular purpose, nor does **onsemi** assume any liability arising out of the application or use of any product or circuit, and specifically disclaims any and all liability, including without limitation special, consequential or incidental damages. Buyer is responsible for its products and applications using **onsemi** products, including compliance with all laws, regulations and safety requirements or standards, regardless of any support or applications information provided by **onsemi**. "Typical" parameters which may be provided in **onsemi** data sheets and/or specifications can and do vary in different applications and actual performance may vary over time. All operating parameters, including "Typicals" must be validated for each customer application by customer's technical experts. **onsemi** does not convey any license under any of its intellectual property rights nor the rights of others. **onsemi** products are not designed, intended, or authorized for use as a critical component in life support systems or any FDA Class 3 medical devices or medical devices with a same or similar classification in a foreign jurisdiction or any devices intended for implantation in the human body. Should Buyer purchase or use **onsemi** products for any such unintended or unauthorized application, Buyer shall indemnify and hold **onsemi** and its officers, employees, subsidiaries, affiliates, and distributors harmless against all claims, costs, damages, and expenses, and reasonable attorney fees arising out of, directly or indirectly, any claim of personal injury or death associated with such unintended or unauthorized use, even if such claim alleges that **onsemi** was negligent regarding the design or manufacture of the part. **onsemi** is an Equal Opportunity/Affirmative Action Employer. This literature is subject to all applicable copyright laws and is not for resale in any manner.

## ADDITIONAL INFORMATION

### TECHNICAL PUBLICATIONS:

Technical Library: [www.onsemi.com/design/resources/technical-documentation](http://www.onsemi.com/design/resources/technical-documentation)  
onsemi Website: [www.onsemi.com](http://www.onsemi.com)

### ONLINE SUPPORT: [www.onsemi.com/support](http://www.onsemi.com/support)

For additional information, please contact your local Sales Representative at [www.onsemi.com/support/sales](http://www.onsemi.com/support/sales)