

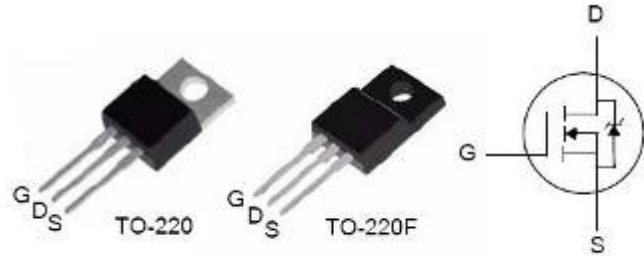
600V N-Channel MOSFET
General Features

- Low ON Resistance
- Low Gate Charge (typical 8.9nC)
- Fast Switching
- 100% Avalanche Tested
- RoHS Compliant/Lead Free

BV_{DSS}	$R_{DS(ON)}$ (Max.)	I_D
600V	4.4Ω	2.2A

Applications

- High Efficiency SMPS
- Adaptor/Charger
- Active PFC
- LCD Panel Power


Ordering Information

Part Number	Package	Marking
FTP02N60	TO-220	FTP02N60
FTA02N60	TO-220F	FTA02N60

Absolute Maximum Ratings
 $T_C=25^{\circ}\text{C}$ unless otherwise specified

Symbol	Parameter	FTP02N60	FTA02N60	Unit
V_{DSS}	Drain-to-Source Voltage ^[1]	600		V
I_D	Continuous Drain Current	2.2	2.2*	A
$I_{D@100^{\circ}\text{C}}$	Continuous Drain Current	Figure 3		
I_{DM}	Pulsed Drain Current, $V_{GS}@10\text{V}^{[2]}$	Figure 6		
P_D	Power Dissipation	54	21	W
	Derating Factor above 25°C	0.43	0.17	W/°C
V_{GS}	Gate-to-Source Voltage	±30		V
E_{AS}	Single Pulse Avalanche Energy $L=30\text{mH}$, $I_D=2.2\text{A}$	72		mJ
dv/dt	Peak Diode Recovery dv/dt ^[3]	4.5		V/ns
T_L	Soldering Temperature	300		°C
	Distance of 1.6mm from case for 10 seconds			
T_J and T_{STG}	Operating and Storage Temperature Range	-55 to 150		

*Drain Current limited by Maximum Junction Temperature.

Caution: Stresses greater than those listed in the "Absolute Maximum Ratings" may cause permanent damage to the device.

Thermal Characteristics

Symbol	Parameter	FTP02N60	FTA02N60	Unit
$R_{\theta JC}$	Thermal Resistance, Junction-to-Case	2.3	6.0	°C/W
$R_{\theta JA}$	Thermal Resistance, Junction-to-Ambient	65	65	



Electrical Characteristics

OFF Characteristics

T_C =25°C unless otherwise specified

Symbol	Parameter	Min.	Typ.	Max.	Unit	Test Conditions
BV _{DSS}	Drain-to-Source Breakdown Voltage	600	--	--	V	V _{GS} =0V, I _D =250μA
ΔBV _{DSS} /ΔT _J	Breakdown Voltage Temperature Coefficient	--	0.6	--	V/°C	Reference to 25°C, I _D =250μA
I _{DSS}	Drain-to-Source Leakage Current	--	--	12	μA	V _{DS} =600V, V _{GS} =0V
		--	--	100		V _{DS} =480V, V _{GS} =0V, T _C =125°C
I _{GSS}	Gate-to-Source Leakage Current	--	--	100	Na	V _{GS} =+30V
		--	--	-100		V _{GS} =-30V

ON Characteristics

T_C =25°C unless otherwise specified

Symbol	Parameter	Min.	Typ.	Max.	Unit	Test Conditions
R _{DS(ON)}	Static Drain-to-Source On-Resistance	--	4.0	4.4	Ω	V _{GS} =10V, I _D =1.3A ^[4]
V _{GS(TH)}	Gate Threshold Voltage	2.0	--	4.0	V	V _{DS} = V _{GS} , I _D =250μA
gfs	Forward Transconductance	--	1.7	--	S	V _{DS} =15V, I _D =2.2A ^[4]

Dynamic Characteristics

Essentially independent of operating temperature

Symbol	Parameter	Min.	Typ.	Max.	Unit	Test Conditions
C _{ISS}	Input Capacitance	--	301	--	Pf	V _{GS} =0V V _{DS} =25V f=1.0MHz Figure 14
C _{OSS}	Output Capacitance	--	23.6	--		
C _{RSS}	Reverse Transfer Capacitance	--	4.6	--		
Q _G	Total Gate Charge	--	8.9	--	nC	V _{DD} =300V I _D =2.2A Figure 15
Q _{GS}	Gate-to-Source Charge	--	1.3	--		
Q _{GD}	Gate-to-Drain (Miller) Charge	--	4.2	--		

Resistive Switching Characteristics

Essentially independent of operating temperature

Symbol	Parameter	Min.	Typ.	Max.	Unit	Test Conditions
t _{d(ON)}	Turn-on Delay Time	--	8	--	Ns	V _{DD} =300V I _D =2.2A V _{GS} =10V R _G =20Ω
t _{rise}	Rise Time	--	25	--		
t _{d(OFF)}	Turn-off Delay Time	--	22	--		
t _{fall}	Fall Time	--	28	--		

Source-Drain Diode Characteristics
 $T_C=25^{\circ}\text{C}$ unless otherwise specified

Symbol	Parameter	Min	Typ.	Max.	Units	Test Conditions
I_{SD}	Continuous Source Current (Body Diode)	--	--	2.2	A	Integral P-N diode in MOSFET
I_{SM}	Maximum Pulsed Current (Body Diode)	--	--	8.8	A	
V_{SD}	Diode Forward Voltage	--	--	1.2	V	$I_S=2.2\text{A}, V_{GS}=0\text{V}$
t_{rr}	Reverse Recovery Time	--	208	--	ns	$V_{GS}=0\text{V}$ $I_F=2.2\text{A}, di/dt=100\text{A}/\mu\text{s}$
Q_{rr}	Reverse Recovery Charge	--	730	--	nC	

NOTE:

[1] $T_J=+25^{\circ}\text{C}$ to $+150^{\circ}\text{C}$

[2] Repetitive rating, pulse width limited by maximum junction temperature.

[3] $I_{SD}=2.2\text{A}$, $di/dt \leq 100\text{A}/\mu\text{s}$, $V_{DD} \leq BV_{DSS}$, $T_J=+150^{\circ}\text{C}$

[4] Pulse width $\leq 380\mu\text{s}$; duty cycle $\leq 2\%$.

Figure 1. Maximum Effective Thermal Impedance, Junction-to-Case

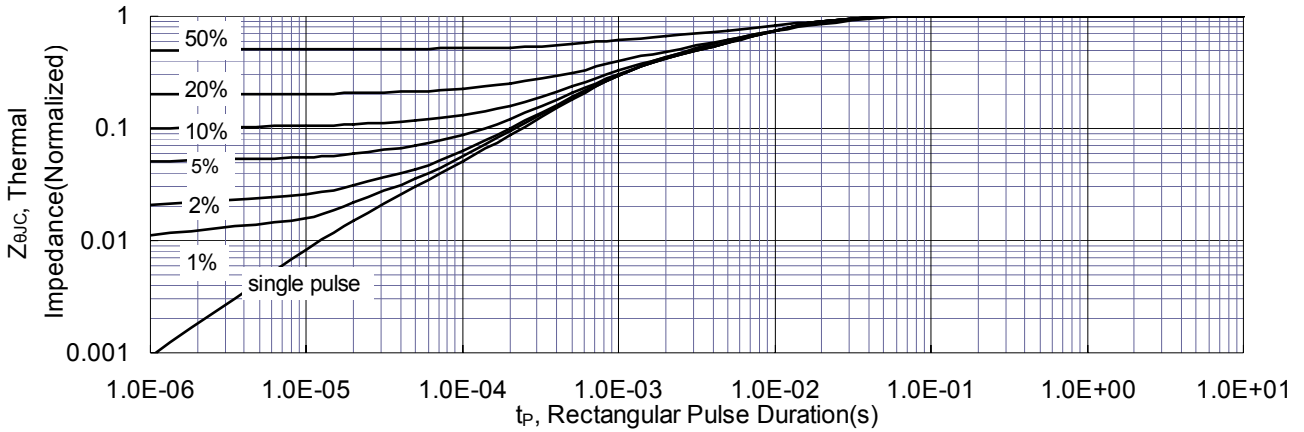


Figure 2. Maximum Power Dissipation vs. Case Temperature

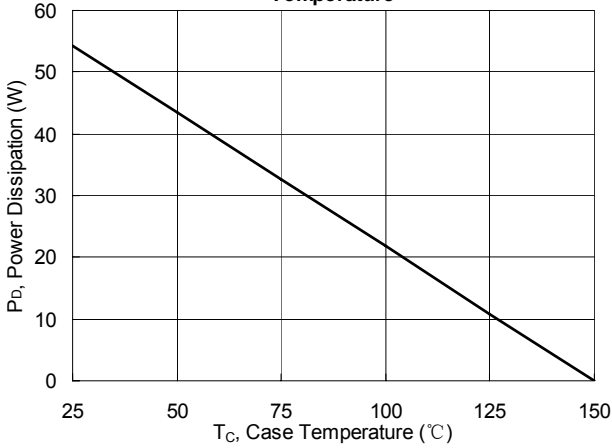


Figure 3. Maximum Continuous Drain Current vs Case Temperature

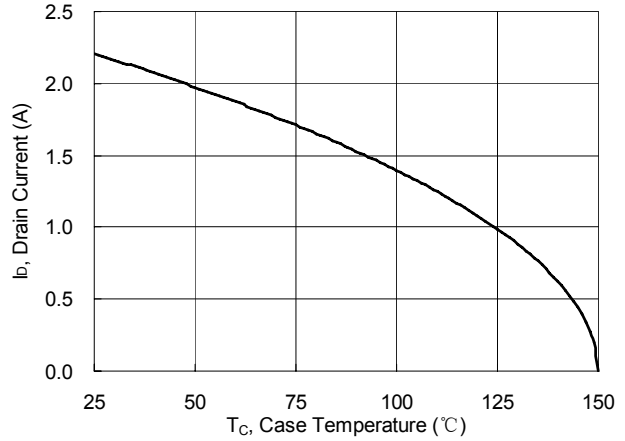


Figure 4. Typical Output Characteristics

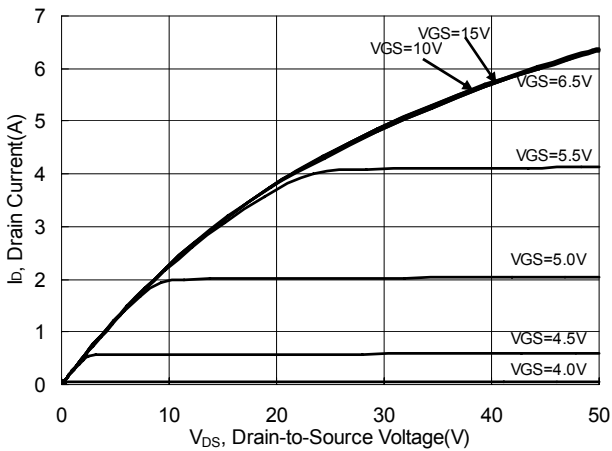


Figure 5. Typical Drain-to-Source ON Resistance vs. Gate Voltage and Drain Current

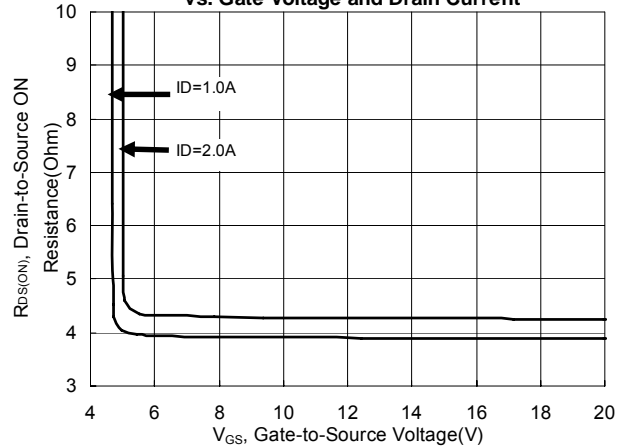


Figure 6. Maximum Peak Current Capability

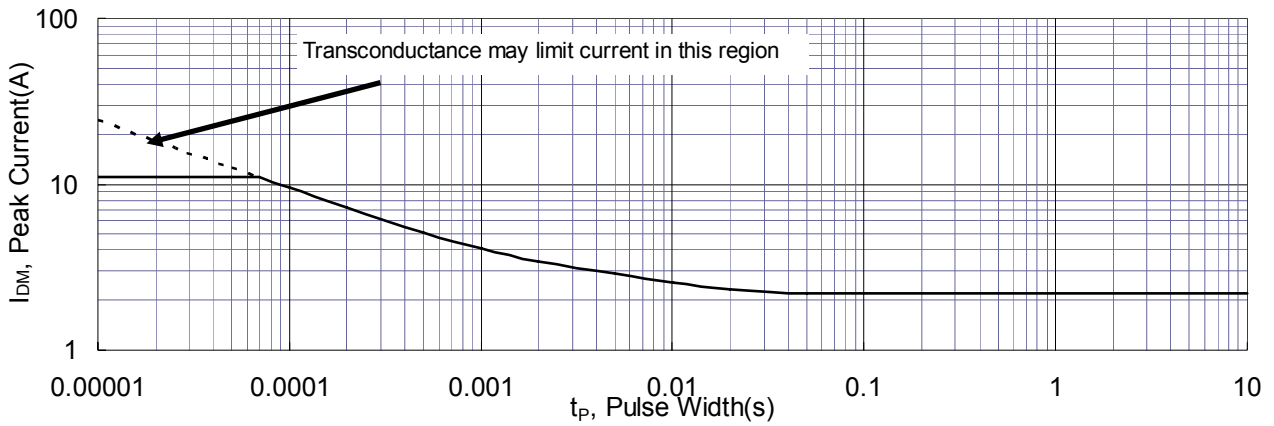


Figure 7. Typical Transfer Characteristics

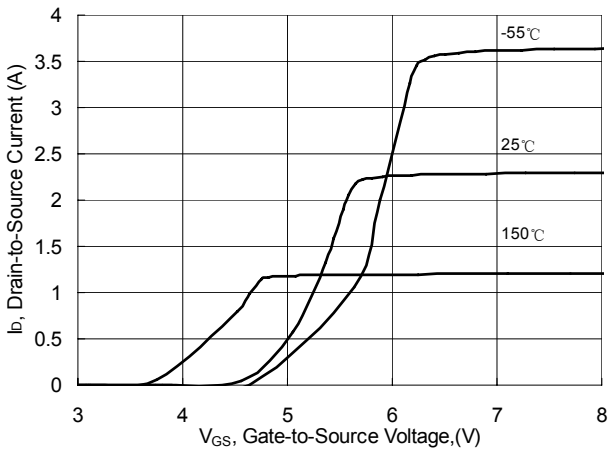


Figure 8. Unclamped Inductive Switching Capability

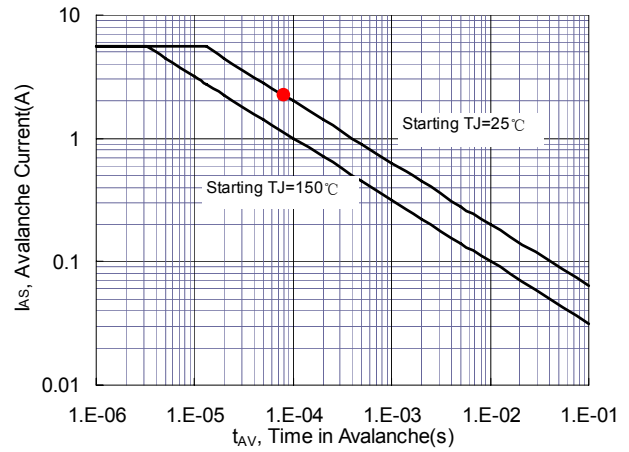


Figure 9. Typical Drain-to-Source ON Resistance

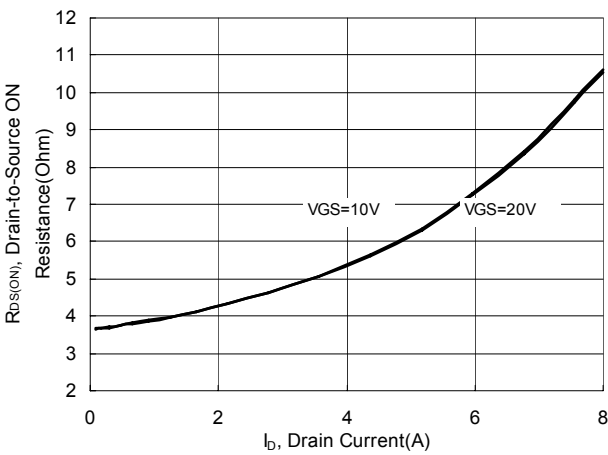


Figure 10. Typical Drain-to-Source On Resistance vs. Junction Temperature

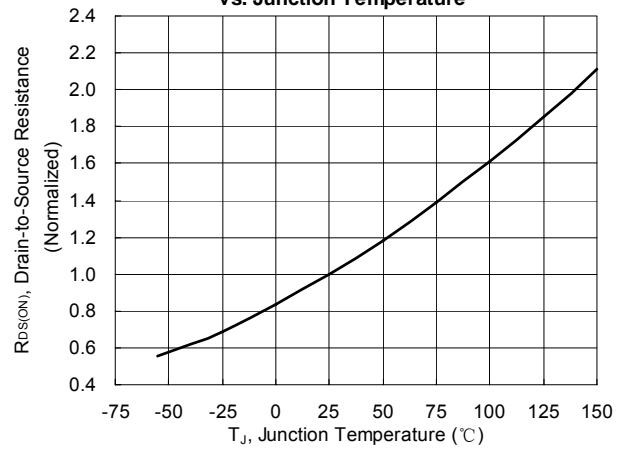


Figure 11. Typical Breakdown Voltage vs. Junction Temperature

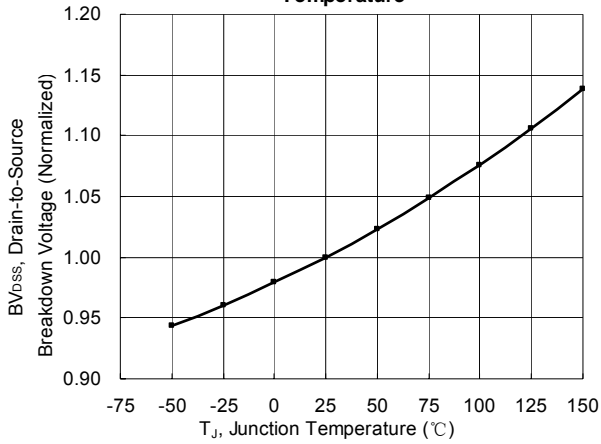


Figure 12. Typical Threshold Voltage vs. Junction Temperature

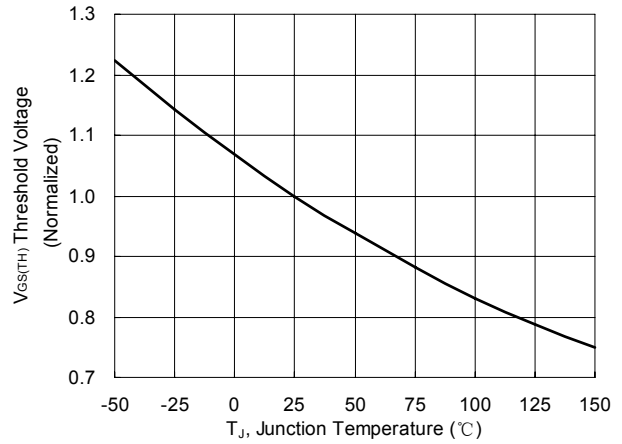


Figure 13. Maximum Forward Safe Operation Area

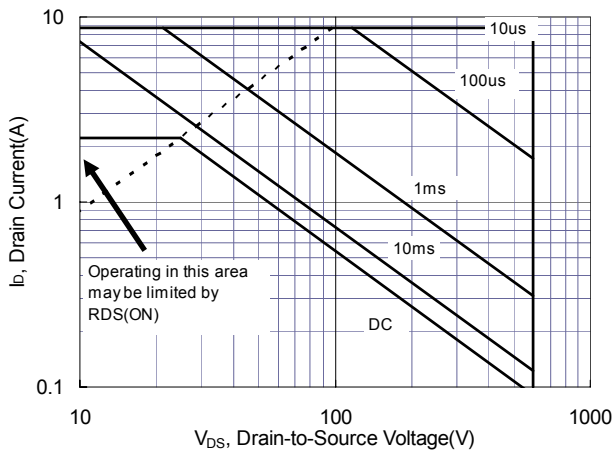


Figure 14. Typical Capacitance vs. Drain-to-Source Voltage

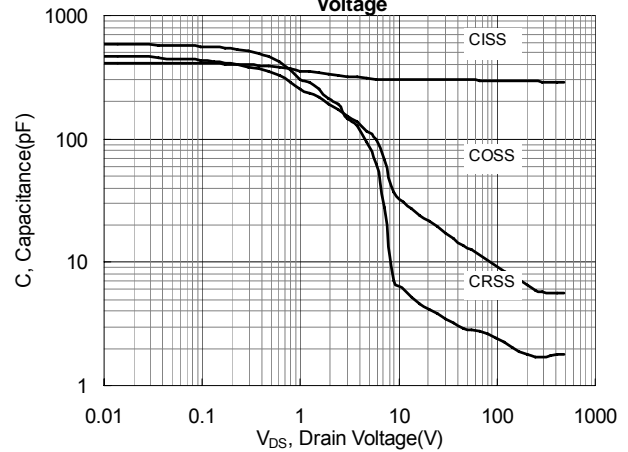


Figure 15. Typical Gate Charge vs. Gate-to-Source Voltage

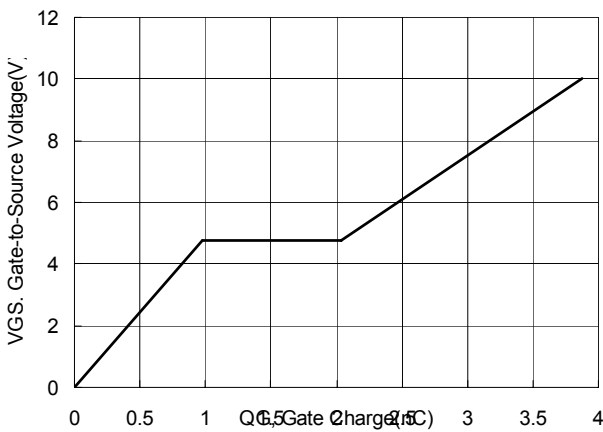
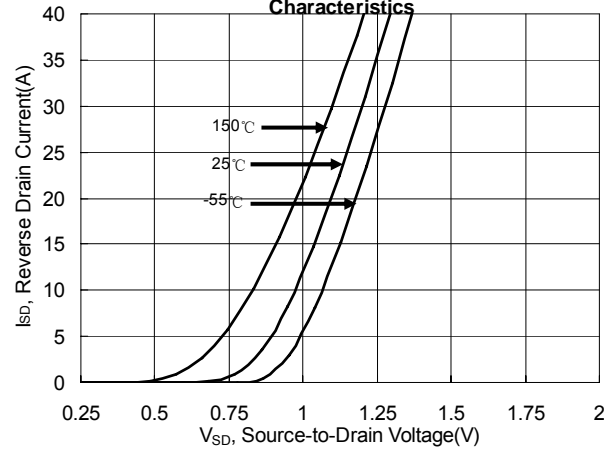


Figure 16. Typical Body Diode Transfer Characteristics



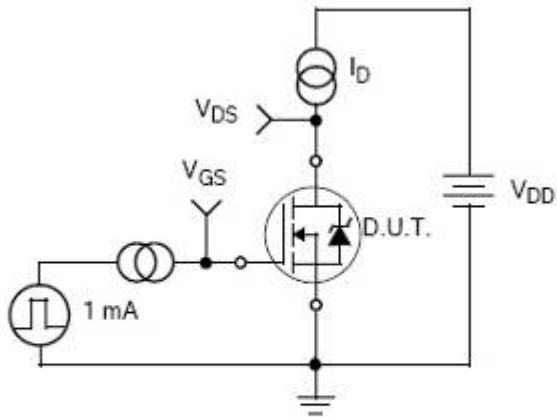
Test Circuit


Figure 17. Gate Charge Test Circuit

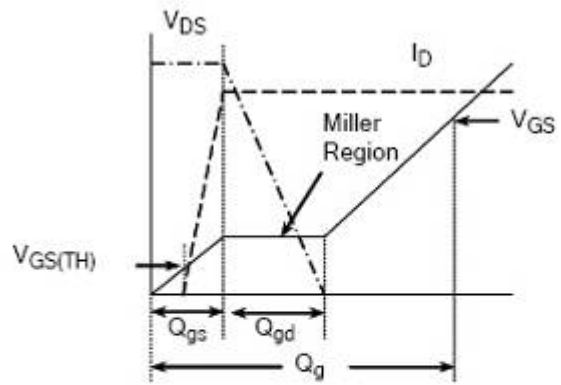


Figure 18. Gate Charge Waveform

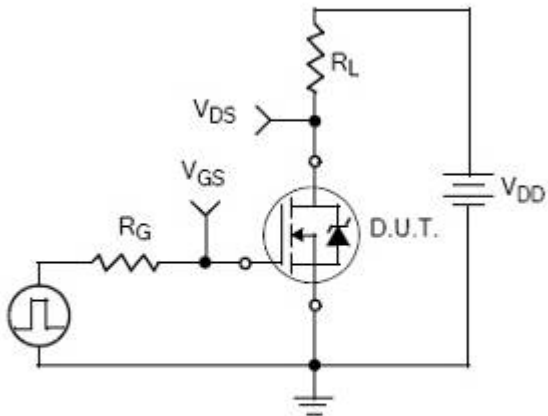


Figure 19. Resistive Switching Test Circuit

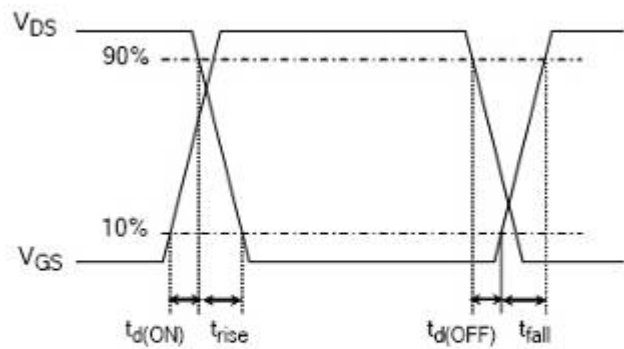


Figure 20. Resistive Switching Waveforms

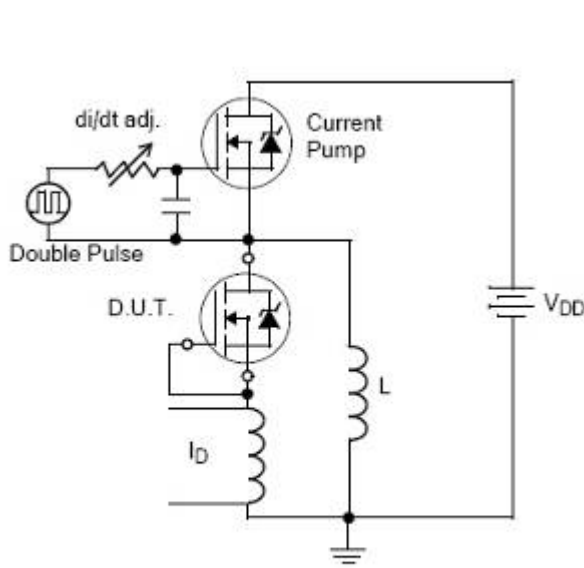


Figure 21. Diode Reverse Recovery Test Circuit

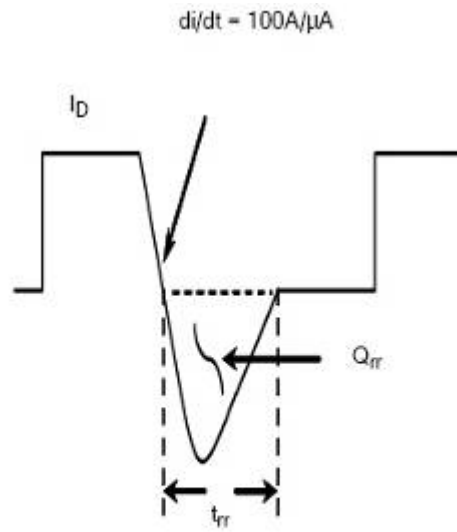


Figure 22. Diode Reverse Recovery Waveform

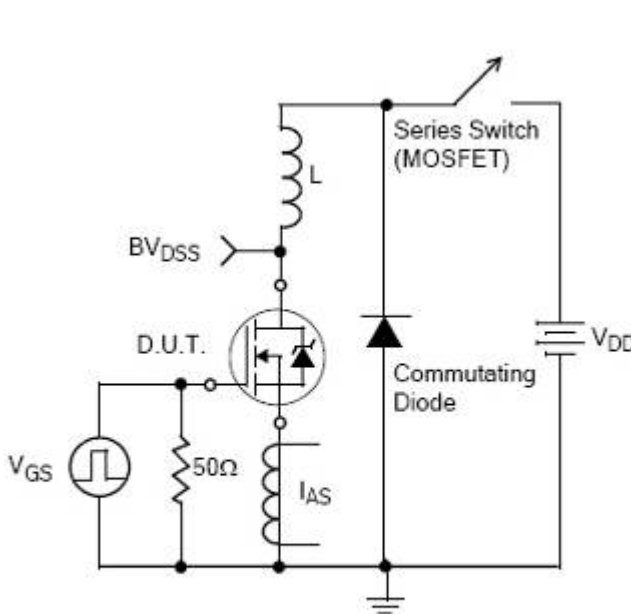


Figure 23. Unclamped Inductive Switching Test Circuit

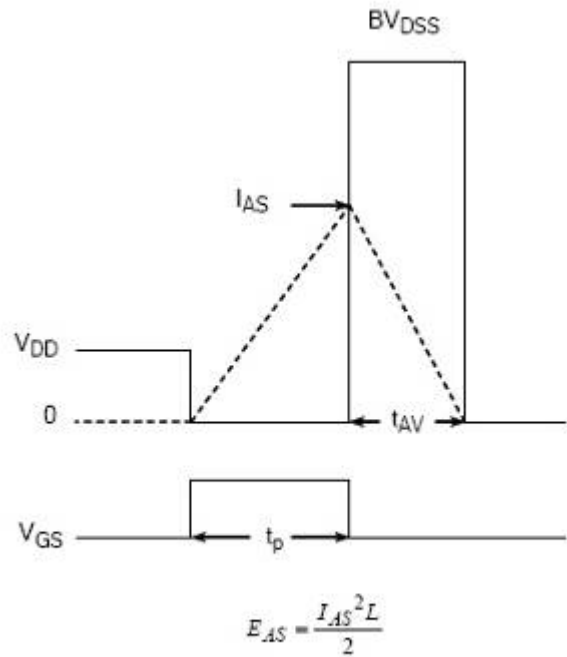
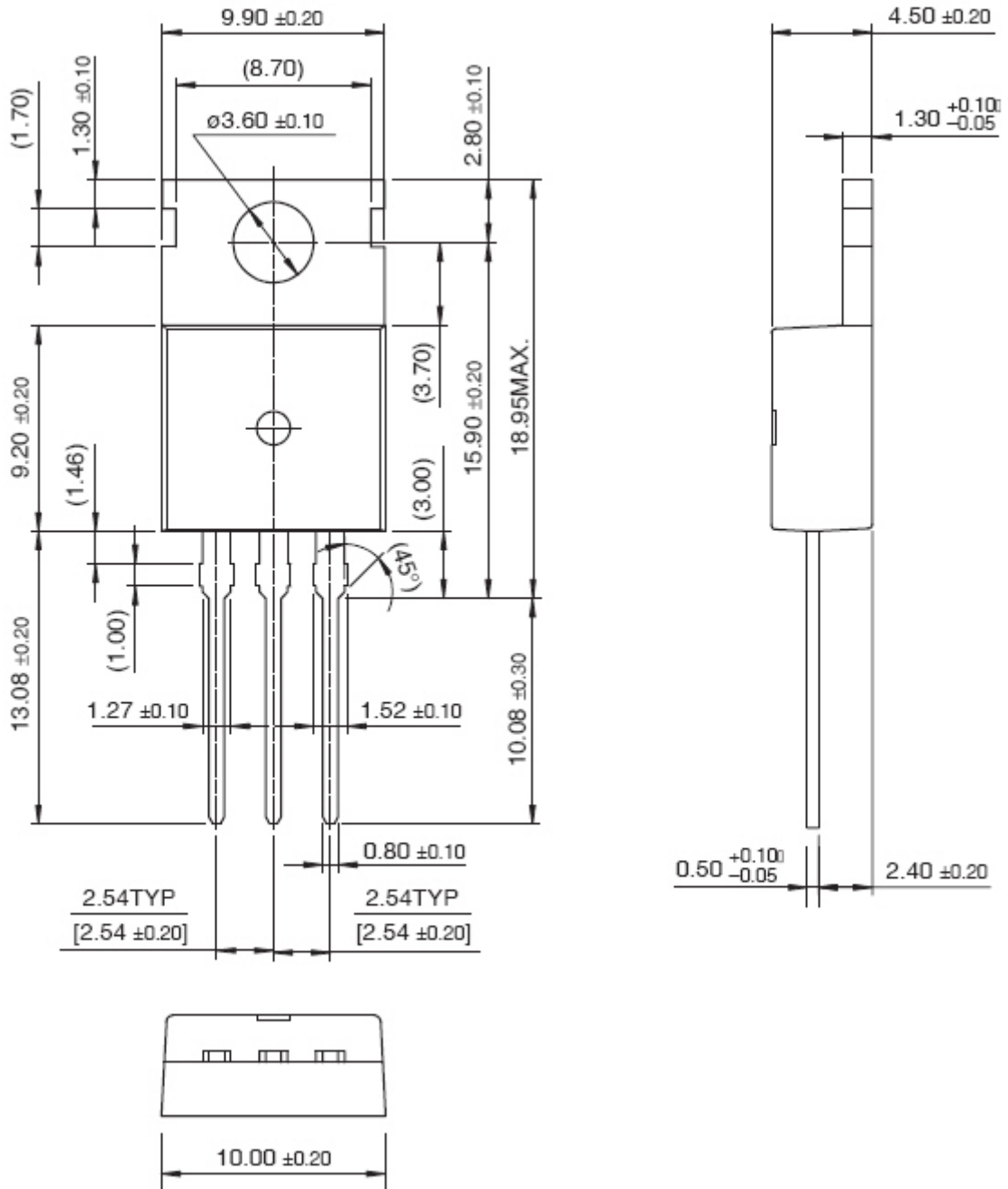
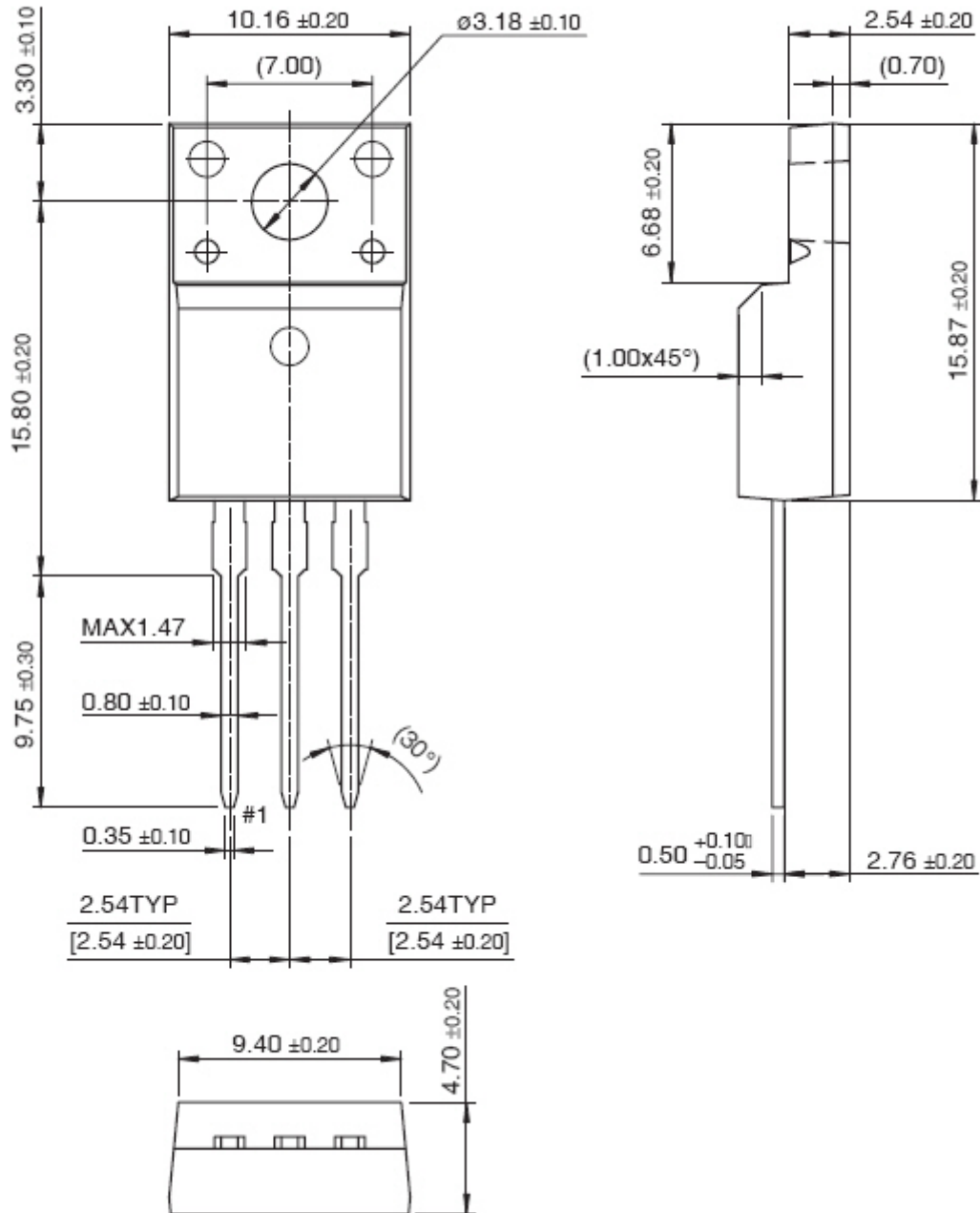


Figure 24. Unclamped Inductive Switching Waveforms

Package Dimensions
TO-220


TO-220F





Published by
ARK Microelectronics Co., Ltd.
No.9, East Zijing Road, High-tek District, Chengdu, P. R. China
All Rights Reserved.

Disclaimers

ARK Microelectronics Co., Ltd. reserves the right to make change without notice in order to improve reliability, function or design and to discontinue any product or service without notice. Customers should obtain the latest relevant information before orders and should verify that such information is current and complete. All products are sold subject to ARK Microelectronics Co., Ltd's terms and conditions supplied at the time of order acknowledgement.

ARK Microelectronics Co., Ltd. warrants performance of its hardware products to the specifications at the time of sale, Testing, reliability and quality control are used to the extent ARK Microelectronics Co., Ltd deems necessary to support this warrantee. Except where agreed upon by contractual agreement, testing of all parameters of each product is not necessary performed.

ARK Microelectronics Co., Ltd. does not assume any liability arising from the use of any product or circuit designs described herein. Customers are responsible for their products and applications using ARK Microelectronics Co., Ltd's components. To minimize risk, customers must provide adequate design and operating safeguards.

ARK Microelectronics Co., Ltd. does not warrant or convey any license either expressed or implied under its patent rights, nor the rights of others. Reproduction of information in ARK Microelectronics Co., Ltd's data sheets or data books is permissible only if reproduction is without modification or alteration. Reproduction of this information with any alteration is an unfair and deceptive business practice. ARK Microelectronics Co., Ltd is not responsible or liable for such altered documentation.

Resale of ARK Microelectronics Co., Ltd's products with statements different from or beyond the parameters stated by ARK Microelectronics Co., Ltd. for the product or service voids all express or implied warranties for the associated ARK Microelectronics Co., Ltd's product or service and is unfair and deceptive business practice. ARK Microelectronics Co., Ltd is not responsible or liable for any such statements.

Life Support Policy:

ARK Microelectronics Co., Ltd's products are not authorized for use as critical components in life devices or systems without the expressed written approval of ARK Microelectronics Co., Ltd.

As used herein:

1. Life support devices or systems are devices or systems which:
 - a. are intended for surgical implant into the human body,
 - b. support or sustain life,
 - c. whose failure to perform when properly used in accordance with instructions for used provided in the labeling, can be reasonably expected to result in significant injury to the user.
 2. A critical component is any component is any component of a life support device or system whose failure to perform can be reasonably expected to cause the failure of the life support device or system, or to affect its safety or effectiveness.
-