

FTSH-110-01-L-DV

Surface
SMT
Mount

.050" MICRO HEADER FTSH SERIES

SPECIFICATIONS

For complete specifications see www.samtec.com?FTSH

Insulator Material:
Black Liquid Crystal Polymer



Terminal Material:
Phosphor Bronze



Plating:

Sn or Au over 50µ" (1,27µm) Ni

Current Rating:

1.75A @ 80°C ambient

Operating Temp Range:

-55°C to +125°C

Note: See SFM/TFM for positive alignment feature.

Note: Some sizes, styles and options are non-standard, non-returnable.

Processing:

Max Processing Temp:

230°C for 60 seconds, or

260°C for 20 seconds 3x with

Matte Sn plating

Lead-Free Solderable:

Yes, with Matte Sn

SMT Lead Coplanarity:

(0,10mm) .004" max (02-25)

(0,15mm) .006" max (26-50)

Suggested Paste Thickness:

For most applications add

(0,05mm) .002" to max SMT

lead coplanarity

Suggested PCB Layouts:

For reference only. Please

contact Samtec or go to

www.samtec.com?FTSH for

recommended PCB layout.

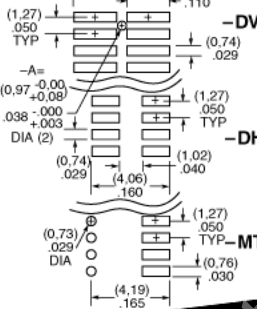

Mates with:
FFSD, CLP, FLE,
SFMC, SFMH

APPLICATIONS



ALSO AVAILABLE

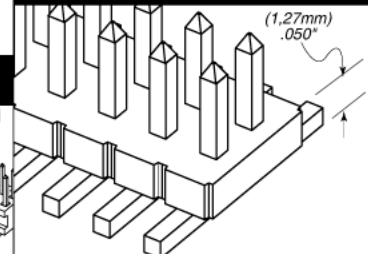

Ultra-low profile option available.
End Shrouds available.
Call for FTS Series specifications.

APPLICATION SPECIFIC OPTION

Molded pick-and-place pads,
latches, single row option and
straddle mount leads available.
Call Samtec.

OPTIONS

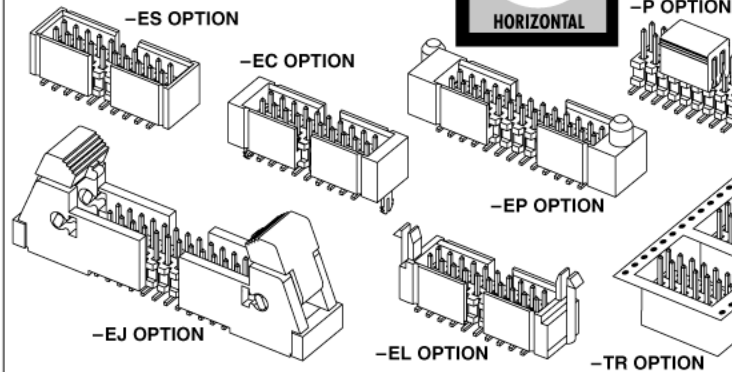

FTSH

1

NO. PINS
PER ROW

LEAD
STYLE

02 thru 50

- 01
= (3,05) .120" Post (Mates with FFSD, FLE)
- 02
= (1,91) .075" Post (Mates with FLE)
- 03
= (1,65) .065" Post (Mates with CLP -D)
- 04
= (3,81) .150" Post (Mates with SFMC, SFMH)

LEAD STYLE	A
-01	(3,05) .120
-02	(1,91) .075
-03	(1,65) .065
-04	(3,81) .150

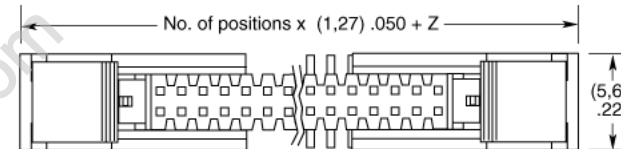
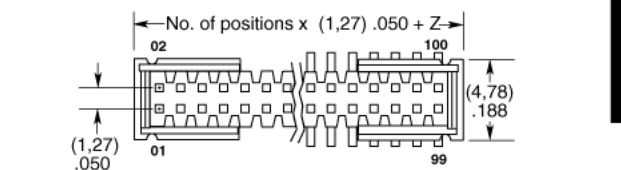
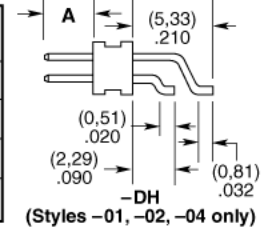

OPTION	Z
-ES	(2,57) .101
-EJ	(15,77) .621
-EC	(3,33) .131
-EP	(5,87) .231
-EL	(6,53) .257

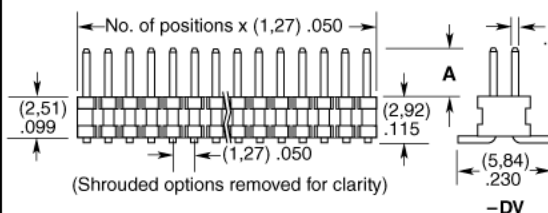

TAPE & REEL AVAILABILITY
No tooling charges.
125 piece minimum order.
Order any quantity above minimum.
In-house design, manufacture.
Quick turn-around.
Call Samtec for specifications
and ordering information.

Due to technical progress, all designs, specifications and components are subject to change without notice.

WWW.SAMTEC.COM

www.DataSheet4U.com

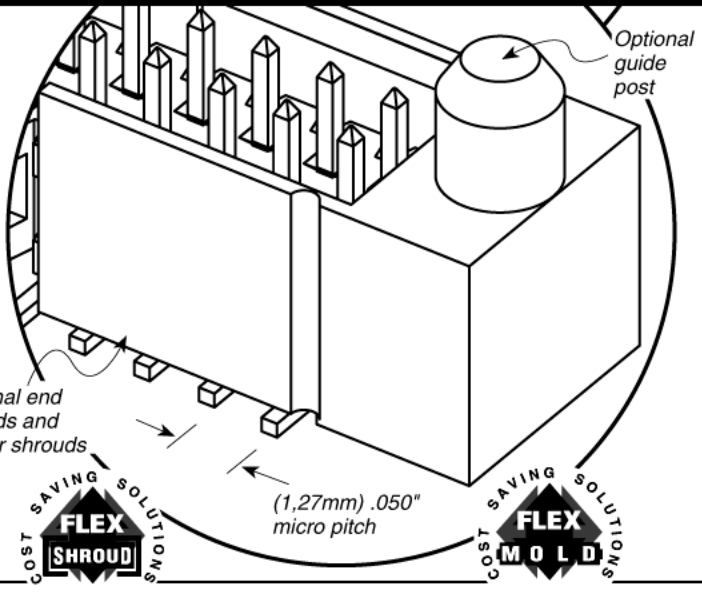
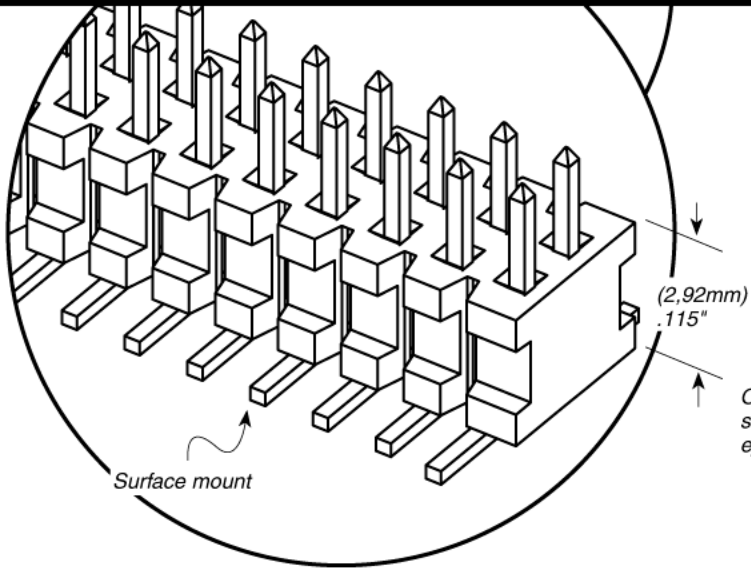
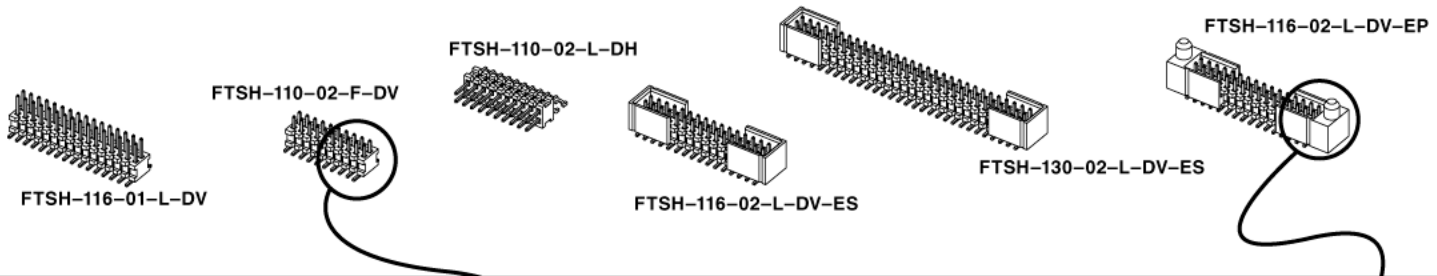

FLEX SHROUD
COST SAVING SOLUTIONS

FLEX MOLD
COST SAVING SOLUTIONS

PLATING OPTION

-L or -LM
= 10µ" (0,25µm) Gold on post, Tin (-L) or Matte Tin (-LM) on tail

-F or -FM
= Gold flash on post, Tin (-F) or Matte Tin (-FM) on tail

TAIL OPTION

-DV
= Double Vertical

-DH
= Double Horizontal (Styles -01, -02 & -04 only)

-MT
= Mixed Technology (Styles -01, -02 & -04 only)

FLEX SHROUD OPTIONS

(Style -02 & -03 only, -DH not available)
9 pins/row minimum

-ES
= End Shroud

-EC
= End Shroud with Locking Clip

-EP
= End Shroud with Guide Post

-EL
= End Shroud with Board Lock (Boards are positively locked and cannot be unmated)

OTHER OPTIONS

-K
= Mating Shroud (For mating with FFSD Styles -01 only, 05, 08, 10, 13, 17, 20 & 25 pins/row only, 13, 17, 20 & 25 only with shrouds)

-A
= Alignment Pin (-DV 3 positions min.) (-DH 5 positions min.) (Metal or plastic at Samtec discretion)

-C
= (4,00mm) .157" DIA Polyimide film Pick & Place Pad (-DH only)

-P
= Pick & Place Pad (-DV 4 positions min.) (-DH & -MT not available)

-TR
= Tape & Reel Packaging (Tail option -DV & -DH only)
Flex Shroud options not available except -ES & -EJ

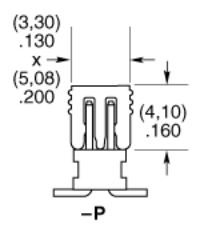
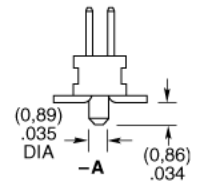
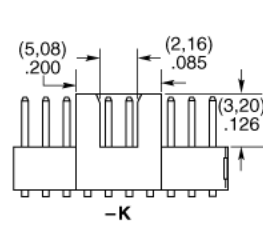
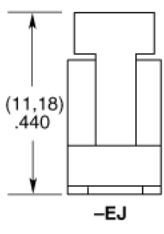
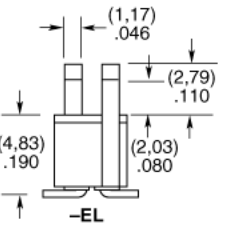
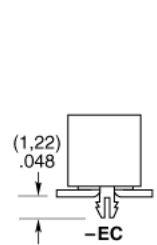
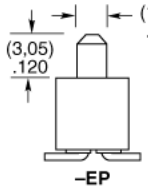
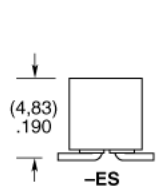

Due to technical progress, all designs, specifications and components are subject to change without notice.

WWW.SAMTEC.COM

SAMTEC USA • Tel: 1-800-SAMTEC-9 or 812-944-6733 • Fax: 812-948-5047
 SAMTEC GERMANY • Tel: +49 (0) 89 / 89460-0 • Fax: +49 (0) 89 / 89460-299
 SAMTEC SCANDINAVIA • Tel: +46-84477280 • Fax: +46-87420413
 SAMTEC ASIA PACIFIC • Tel: 65 6745-5955 • Fax: 65 6841-1502
 SAMTEC HONG KONG • Tel: 852-26904858 • Fax: 852-26904842
 SAMTEC SILICON VALLEY • Tel: 408-395-5900 • Fax: 408-395-1520
 SAMTEC FRANCE • Tel: 01 60 95 06 60 • Fax: 01 60 95 06 61
 SAMTEC ISRAEL • Tel: 972-3-7526600 • Fax: 972-3-7526690
 SAMTEC CHINA • Tel: 86-21-5385-4089 • Fax: 86-21-5385-4047
 SAMTEC SOUTH AFRICA • Tel: 27 11 4528112 • Fax: 27 86 6714432
 SAMTEC UK • Tel: 01236 739292 • Fax: 01236 727113
 SAMTEC ITALY • Tel: 39 039 6890337 • Fax: 39 039 6890315
 SAMTEC INDIA • Tel: 91 80 306 21 612 • Fax: 91 80 5152 8187
 SAMTEC TAIWAN • Tel: 886 02 2698-3367 • Fax: 886 02 8698-2159
 SAMTEC ANZ • Tel: 613 9512 7747 • Fax: 613 9512 7745