



FW4604

Power MOSFET

30V, 6A, 39mΩ, -30V, -4.5A, 65mΩ, Complementary Dual SOIC8

ON Semiconductor®

<http://onsemi.com>

Features

- On-state resistance Nch : $R_{DS(on)1}=30m\Omega$ (typ.)
Pch : $R_{DS(on)1}=50m\Omega$ (typ.)
- 4.5V drive
- Halogen free compliance
- Nch + Pch MOSFET
- Protection diode in

Specifications

Absolute Maximum Ratings at $T_a=25^\circ C$

Parameter	Symbol	Conditions	N-channel	P-channel	Unit
Drain to Source Voltage	V_{DSS}		30	-30	V
Gate to Source Voltage	V_{GSS}		± 20	± 20	V
Drain Current (DC)	I_D		6	-4.5	A
Drain Current ($PW \leq 10s$)	I_{DP}	Duty cycle $\leq 1\%$	6.5	-5	A
Drain Current ($PW \leq 10\mu s$)	I_{DP}	Duty cycle $\leq 1\%$	24	-18	A
Allowable Power Dissipation	P_D	When mounted on ceramic substrate (2000mm ² ×0.8mm) 1unit, $PW \leq 10s$	1.8		W
Total Dissipation	P_T	When mounted on ceramic substrate (2000mm ² ×0.8mm), $PW \leq 10s$	2.2		W
Channel Temperature	T_{ch}		150		°C
Storage Temperature	T_{stg}		-55 to +150		°C

Stresses exceeding Maximum Ratings may damage the device. Maximum Ratings are stress ratings only. Functional operation above the Recommended Operating Conditions is not implied. Extended exposure to stresses above the Recommended Operating Conditions may affect device reliability.

Package Dimensions

unit : mm (typ)

7072-001

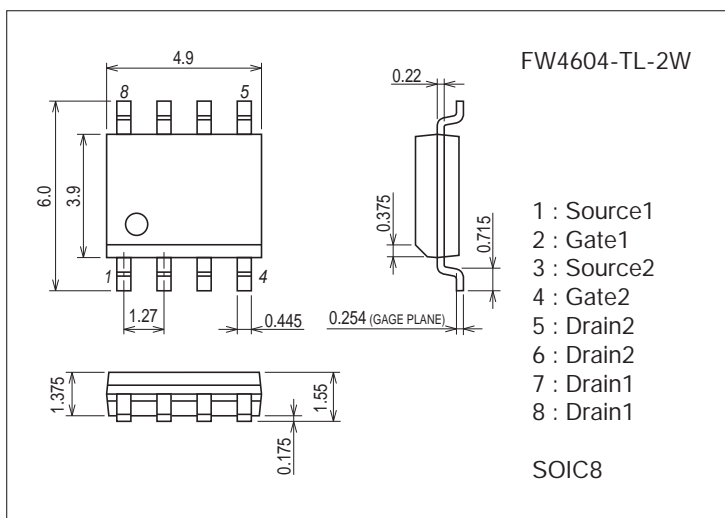

Product & Package Information

- Package : SOIC8
- JEITA, JEDEC : SC-87, SOT-96
- Minimum Packing Quantity : 2,500 pcs./reel

Packing Type : TL

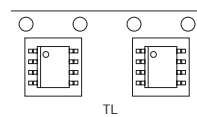

Marking

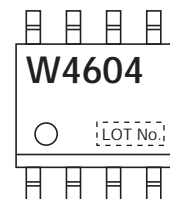

Electrical Connection

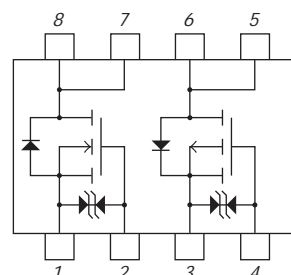

FW4604

Electrical Characteristics at Ta=25°C

Parameter	Symbol	Conditions	Ratings			Unit
			min	typ	max	
[N-channel]						
Drain to Source Breakdown Voltage	$V_{(BR)DSS}$	$I_D=1mA, V_{GS}=0V$	30			V
Zero-Gate Voltage Drain Current	I_{DSS}	$V_{DS}=30V, V_{GS}=0V$			1	μA
Gate to Source Leakage Current	I_{GSS}	$V_{GS}=\pm 16V, V_{DS}=0V$			± 10	μA
Cutoff Voltage	$V_{GS(off)}$	$V_{DS}=10V, I_D=1mA$	1.7		2.6	V
Forward Transfer Admittance	$ y_{fs} $	$V_{DS}=10V, I_D=6A$		3		S
Static Drain to Source On-State Resistance	$R_{DS(on)1}$	$I_D=6A, V_{GS}=10V$		30	39	$m\Omega$
	$R_{DS(on)2}$	$I_D=3A, V_{GS}=4.5V$		50	70	$m\Omega$
Input Capacitance	C_{iss}	$V_{DS}=10V, f=1MHz$		490		pF
Output Capacitance	C_{oss}			85		pF
Reverse Transfer Capacitance	C_{rss}			45		pF
Turn-ON Delay Time	$t_{d(on)}$		See specified Test Circuit.		8	
Rise Time	t_r			45		ns
Turn-OFF Delay Time	$t_{d(off)}$			31		ns
Fall Time	t_f			28		ns
Total Gate Charge	Q_g	$V_{DS}=15V, V_{GS}=10V, I_D=6A$			9.1	
Gate to Source Charge	Q_{gs}			1.7		nC
Gate to Drain "Miller" Charge	Q_{gd}			1.7		nC
Diode Forward Voltage	V_{SD}	$I_S=6A, V_{GS}=0V$		0.84	1.2	V
[P-channel]						
Drain to Source Breakdown Voltage	$V_{(BR)DSS}$	$I_D=-1mA, V_{GS}=0V$	-30			V
Zero-Gate Voltage Drain Current	I_{DSS}	$V_{DS}=-30V, V_{GS}=0V$			-1	μA
Gate to Source Leakage Current	I_{GSS}	$V_{GS}=\pm 16V, V_{DS}=0V$			± 10	μA
Cutoff Voltage	$V_{GS(off)}$	$V_{DS}=-10V, I_D=-1mA$	-1.7		-2.6	V
Forward Transfer Admittance	$ y_{fs} $	$V_{DS}=-10V, I_D=-4.5A$		5.2		S
Static Drain to Source On-State Resistance	$R_{DS(on)1}$	$I_D=-4.5A, V_{GS}=-10V$		50	65	$m\Omega$
	$R_{DS(on)2}$	$I_D=-2.5A, V_{GS}=-4.5V$		85	119	$m\Omega$
Input Capacitance	C_{iss}	$V_{DS}=-10V, f=1MHz$		430		pF
Output Capacitance	C_{oss}			105		pF
Reverse Transfer Capacitance	C_{rss}			75		pF
Turn-ON Delay Time	$t_{d(on)}$		See specified Test Circuit.		7.5	
Rise Time	t_r			42		ns
Turn-OFF Delay Time	$t_{d(off)}$			43		ns
Fall Time	t_f			40		ns
Total Gate Charge	Q_g	$V_{DS}=-15V, V_{GS}=-10V, I_D=-4.5A$			10	
Gate to Source Charge	Q_{gs}			2.0		nC
Gate to Drain "Miller" Charge	Q_{gd}			2.5		nC
Diode Forward Voltage	V_{SD}	$I_S=-4.5A, V_{GS}=0V$		-0.86	-1.5	V

Switching Time Test Circuit

[N-channel]

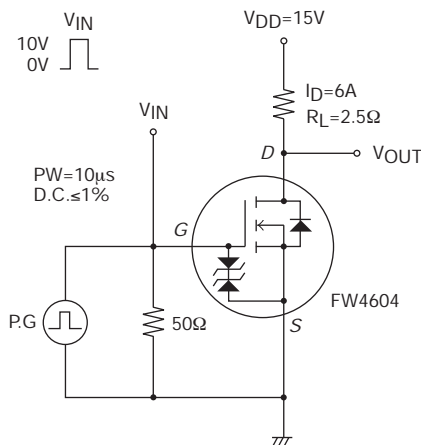

[P-channel]

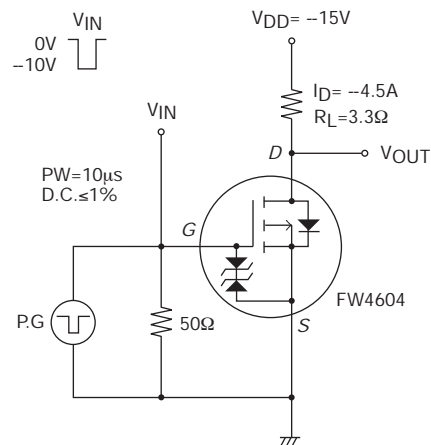

Ordering Information

Device	Package	Shipping	memo
FW4604-TL-2W	SOIC8	2,500pcs./reel	Pb-Free and Halogen Free

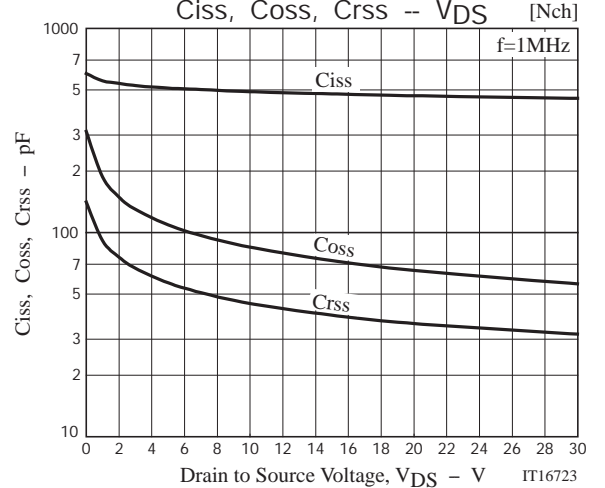
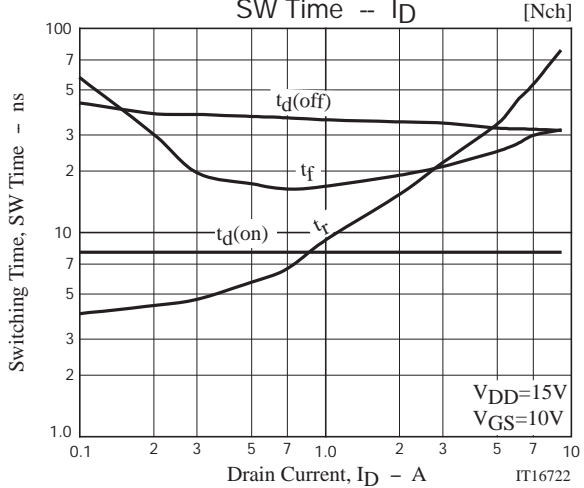
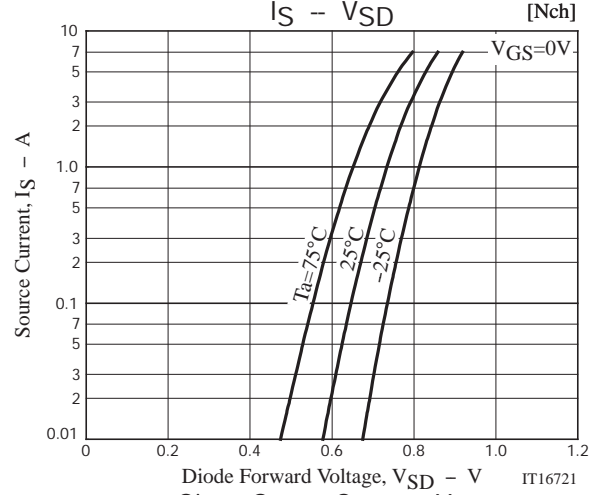
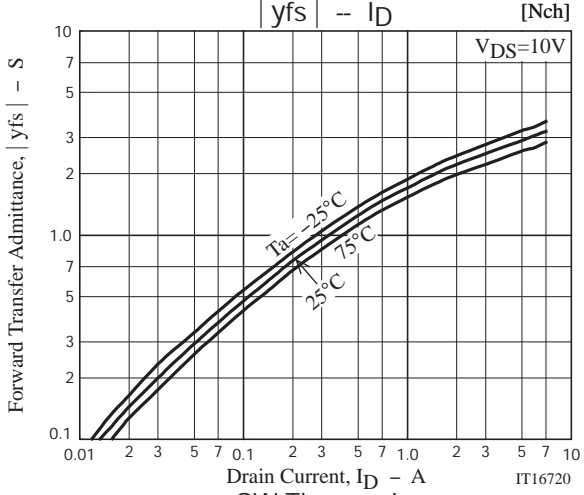
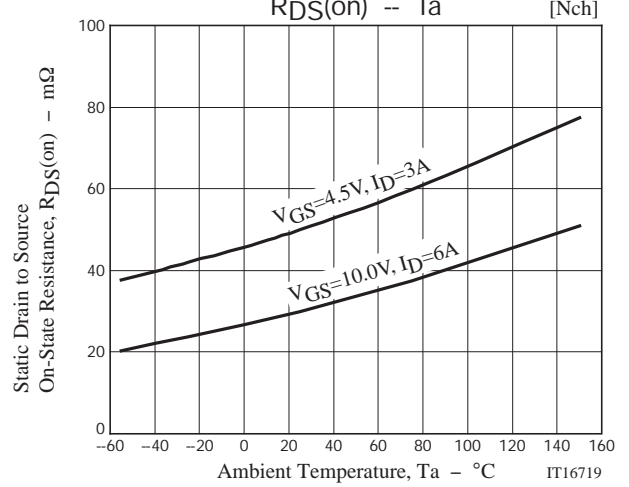
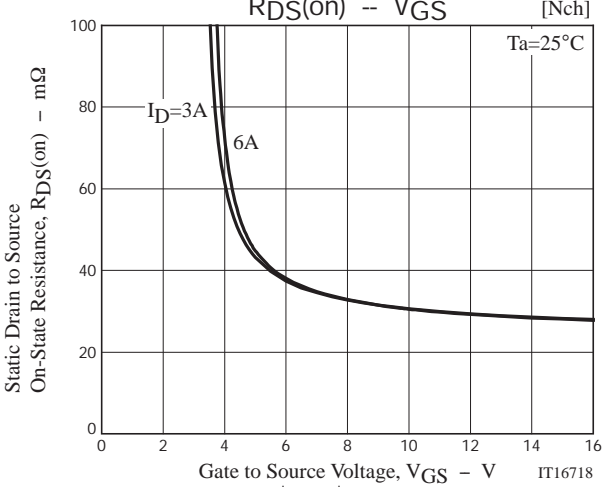
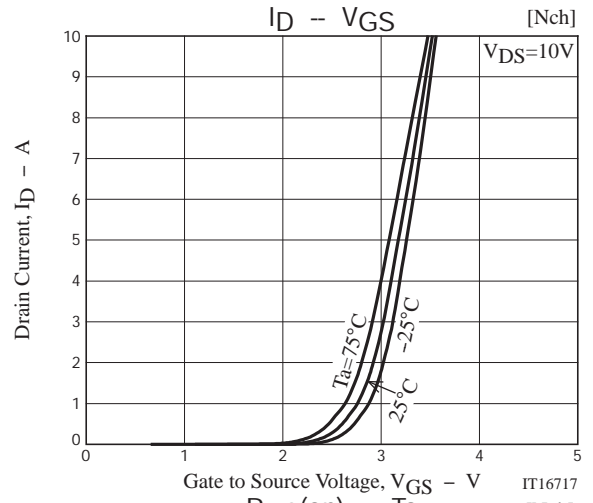
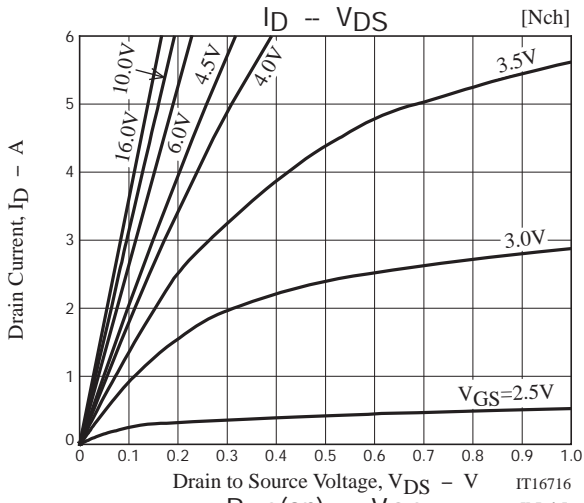

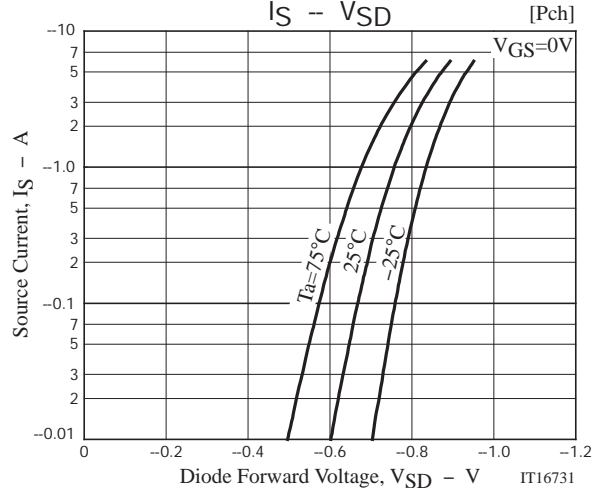
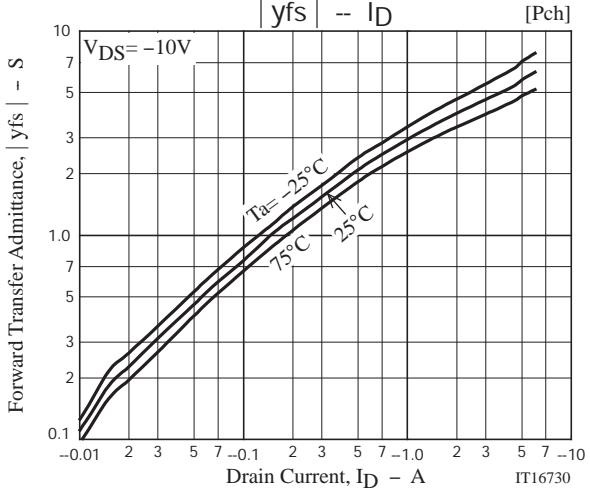
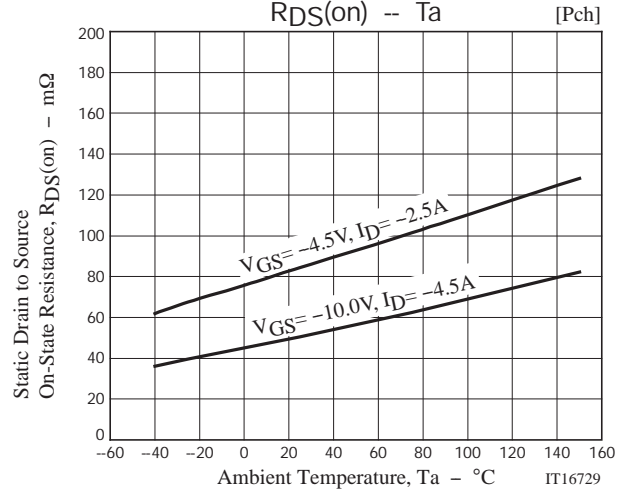
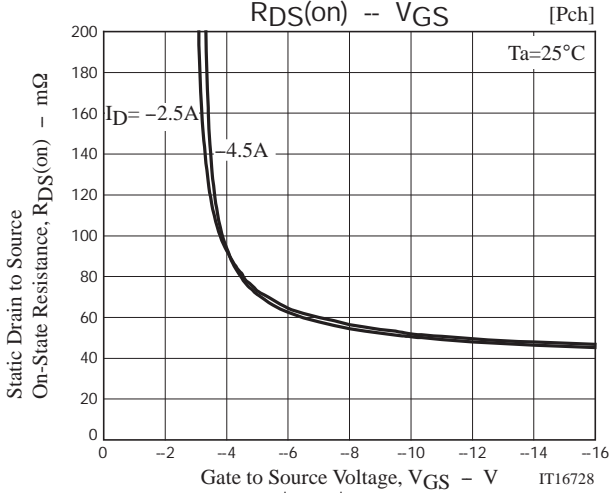
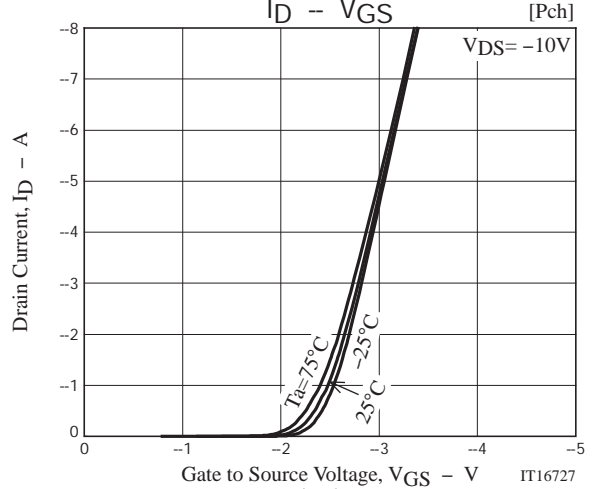
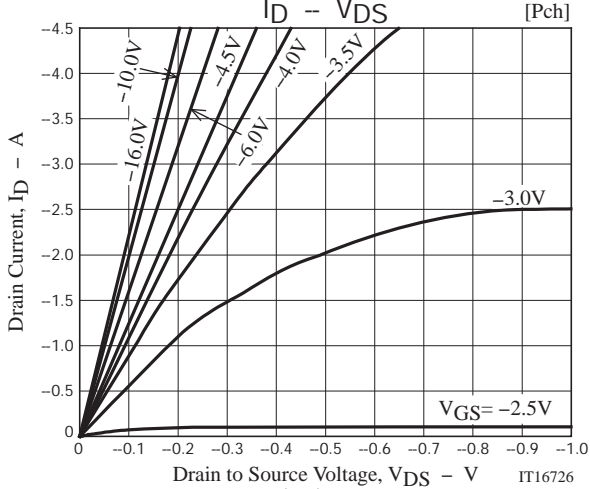
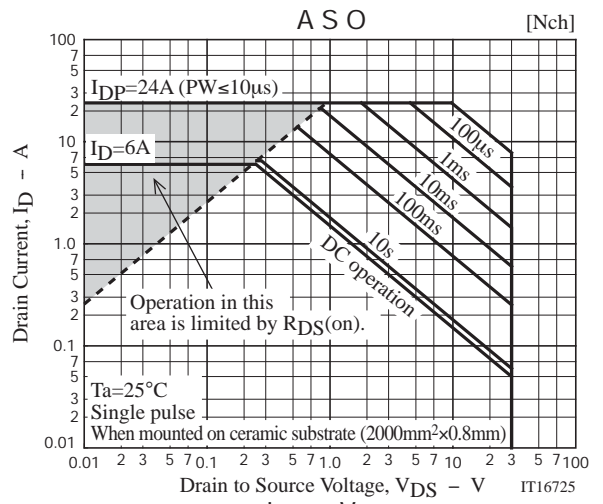
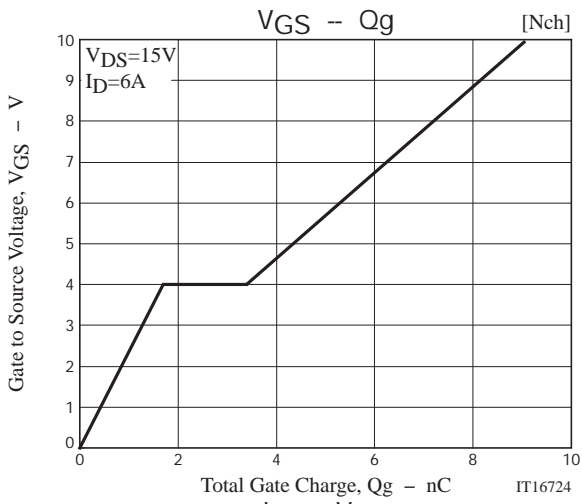

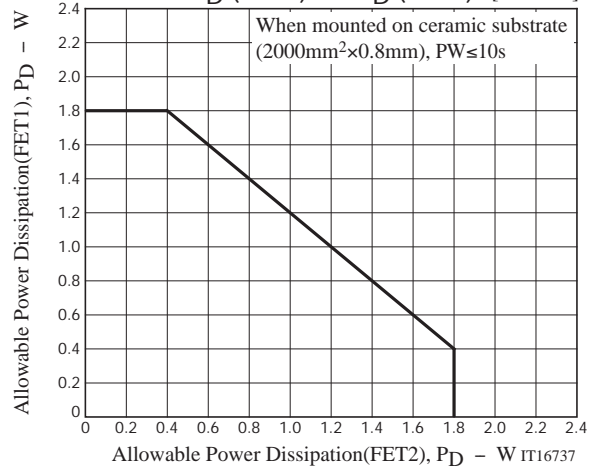
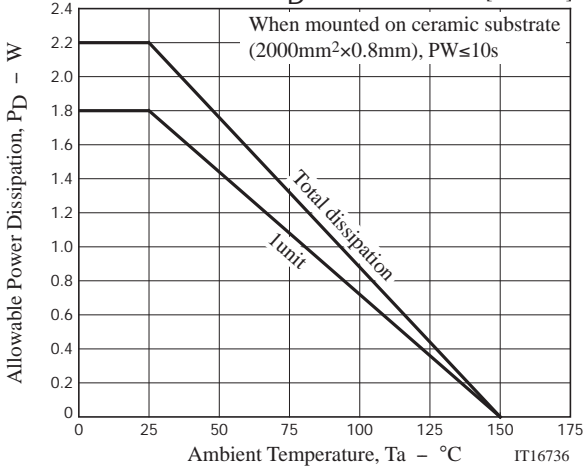
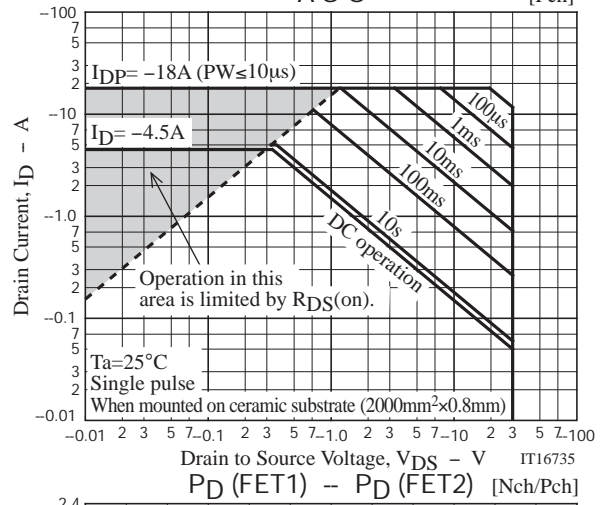
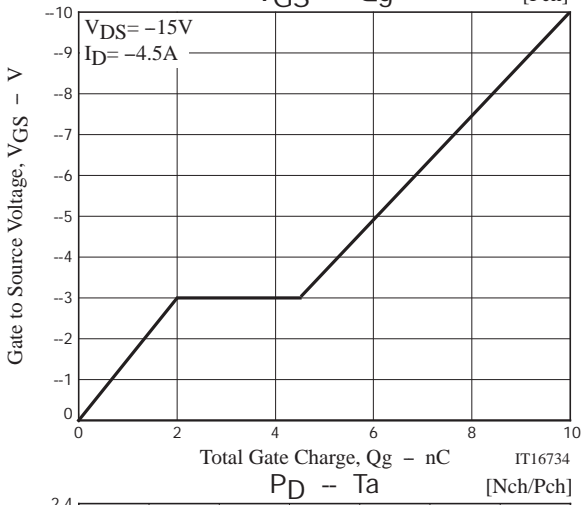
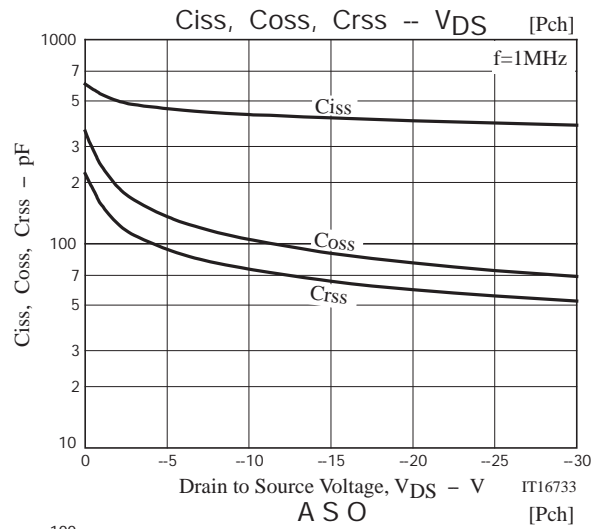
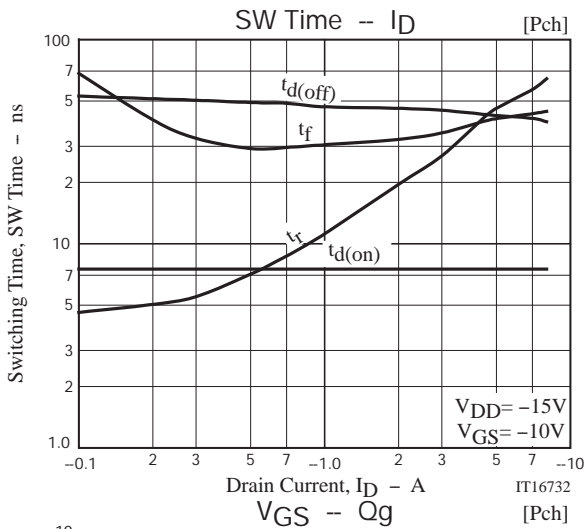

Outline Drawing

FW4604-TL-2W

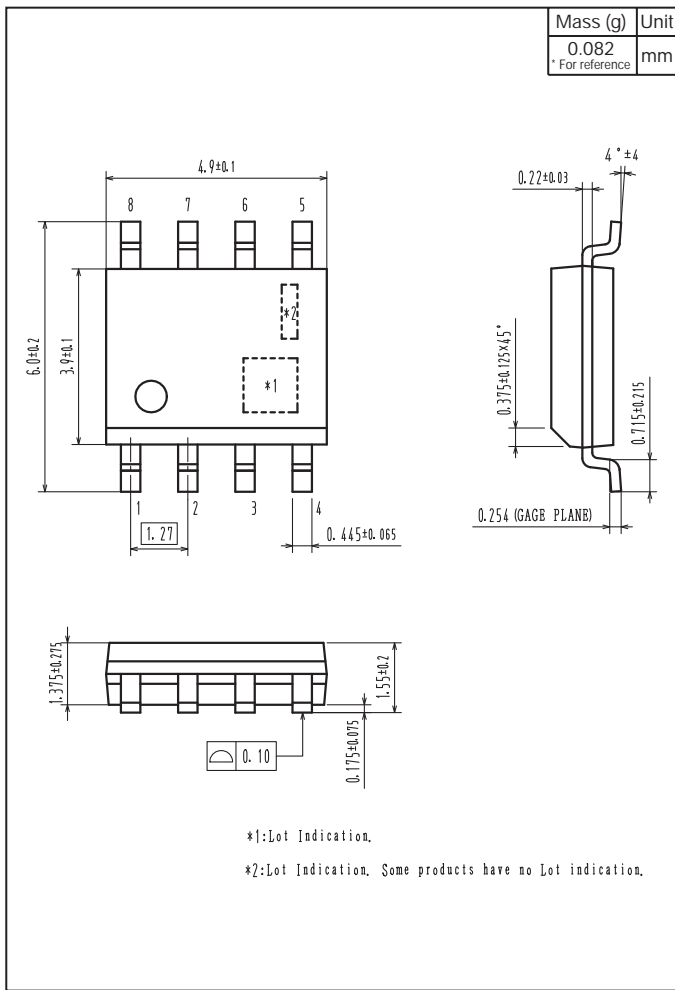

Land Pattern Example

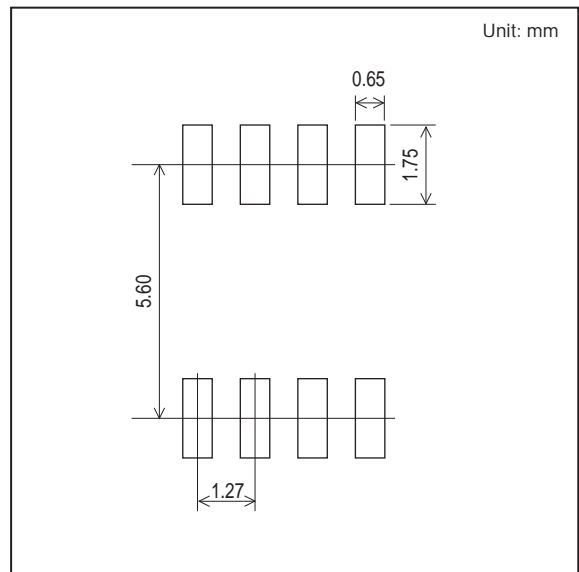

Note on usage : Since the FW4604 is a MOSFET product, please avoid using this device in the vicinity of highly charged objects.

ON Semiconductor and the ON logo are registered trademarks of Semiconductor Components Industries, LLC (SCILLC). SCILLC owns the rights to a number of patents, trademarks, copyrights, trade secrets, and other intellectual property. A listing of SCILLC's product/patent coverage may be accessed at www.onsemi.com/site/pdf/Patent-Marking.pdf. SCILLC reserves the right to make changes without further notice to any products herein. SCILLC makes no warranty, representation or guarantee regarding the suitability of its products for any particular purpose, nor does SCILLC assume any liability arising out of the application or use of any product or circuit, and specifically disclaims any and all liability, including without limitation special, consequential or incidental damages. "Typical" parameters which may be provided in SCILLC data sheets and/or specifications can and do vary in different applications and actual performance may vary over time. All operating parameters, including "Typicals" must be validated for each customer application by customer's technical experts. SCILLC does not convey any license under its patent rights nor the rights of others. SCILLC products are not designed, intended, or authorized for use as components in systems intended for surgical implant into the body, or other applications intended to support or sustain life, or for any other application in which the failure of the SCILLC product could create a situation where personal injury or death may occur. Should Buyer purchase or use SCILLC products for any such unintended or unauthorized application, Buyer shall indemnify and hold SCILLC and its officers, employees, subsidiaries, affiliates, and distributors harmless against all claims, costs, damages, and expenses, and reasonable attorney fees arising out of, directly or indirectly, any claim of personal injury or death associated with such unintended or unauthorized use, even if such claim alleges that SCILLC was negligent regarding the design or manufacture of the part. SCILLC is an Equal Opportunity/Affirmative Action Employer. This literature is subject to all applicable copyright laws and is not for resale in any manner.