



SANYO Semiconductors

DATA SHEET

An ON Semiconductor Company

N-Channel and P-Channel Silicon MOSFETs

FW907 — General-Purpose Switching Device Applications

Features

- ON-resistance Nch: $R_{DS(on)1}=13m\Omega(typ.)$, Pch: $R_{DS(on)1}=20m\Omega(typ.)$
- 4V drive
- N-channel MOSFET + P-channel MOSFET

Specifications

Absolute Maximum Ratings at $T_a=25^\circ C$

Parameter	Symbol	Conditions	N-channel	P-channel	Unit
Drain-to-Source Voltage	V_{DSS}		30	-30	V
Gate-to-Source Voltage	V_{GSS}		± 20	± 20	V
Drain Current (DC)	I_D		10	-8	A
Drain Current ($PW \leq 10s$)	I_D	Duty cycle $\leq 1\%$	11.5	-9	A
Drain Current ($PW \leq 100ms$)	I_D	Duty cycle $\leq 1\%$	24	-19	A
Drain Current ($PW \leq 10\mu s$)	I_{DP}	Duty cycle $\leq 1\%$	52	-52	A
Allowable Power Dissipation	P_D	When mounted on ceramic substrate (2000mm ² ×0.8mm) 1unit, $PW \leq 10s$	2.3		W
Total Dissipation	P_T	When mounted on ceramic substrate (2000mm ² ×0.8mm), $PW \leq 10s$	2.5		W
Channel Temperature	T_{ch}		150		$^\circ C$
Storage Temperature	T_{stg}		-55 to +150		$^\circ C$

Package Dimensions

unit : mm (typ)

7005A-003

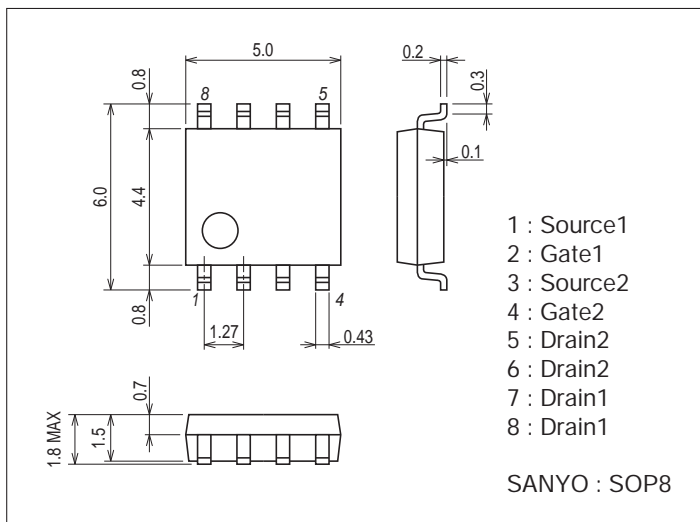

Product & Package Information

- Package : SOP8
- JEITA, JEDEC : SC-87, SOT96
- Minimum Packing Quantity : 1,000 pcs./reel

Packing Type : TL

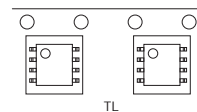

Marking

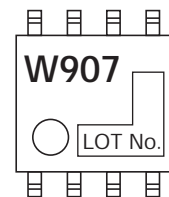

Electrical Connection

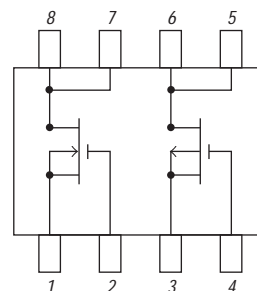

FW907

Electrical Characteristics at Ta=25°C

Parameter	Symbol	Conditions	Ratings			Unit
			min	typ	max	
[N-channel]						
Drain-to-Source Breakdown Voltage	V(BR)DSS	ID=1mA, VGS=0V	30			V
Zero-Gate Voltage Drain Current	IDSS	VDS=30V, VGS=0V			1	μA
Gate-to-Source Leakage Current	IGSS	VGS=±16V, VDS=0V			±10	μA
Cutoff Voltage	VGS(off)	VDS=10V, ID=1mA	1.2		2.6	V
Forward Transfer Admittance	yfs	VDS=10V, ID=10A		5.2		S
Static Drain-to-Source On-State Resistance	RDS(on)1	ID=10A, VGS=10V		13	17	mΩ
	RDS(on)2	ID=5A, VGS=4.5V		21	30	mΩ
	RDS(on)3	ID=5A, VGS=4V		27	38	mΩ
Input Capacitance	Ciss	VDS=10V, f=1MHz		1000		pF
Output Capacitance	Coss	VDS=10V, f=1MHz		170		pF
Reverse Transfer Capacitance	Crss	VDS=10V, f=1MHz		100		pF
Turn-ON Delay Time	td(on)	See specified Test Circuit.		12		ns
Rise Time	tr	See specified Test Circuit.		75		ns
Turn-OFF Delay Time	td(off)	See specified Test Circuit.		57		ns
Fall Time	tf	See specified Test Circuit.		44		ns
Total Gate Charge	Qg	VDS=15V, VGS=10V, ID=10A		17		nC
Gate-to-Source Charge	Qgs	VDS=15V, VGS=10V, ID=10A		3.6		nC
Gate-to-Drain "Miller" Charge	Qgd	VDS=15V, VGS=10V, ID=10A		3.0		nC
Diode Forward Voltage	VSD	IS=10A, VGS=0V		0.85	1.2	V
[P-channel]						
Drain-to-Source Breakdown Voltage	V(BR)DSS	ID=-1mA, VGS=0V	-30			V
Zero-Gate Voltage Drain Current	IDSS	VDS=-30V, VGS=0V			-1	μA
Gate-to-Source Leakage Current	IGSS	VGS=±16V, VDS=0V			±10	μA
Cutoff Voltage	VGS(off)	VDS=-10V, ID=-1mA	-1.2		-2.6	V
Forward Transfer Admittance	yfs	VDS=-10V, ID=-8A		10		S
Static Drain-to-Source On-State Resistance	RDS(on)1	ID=-8A, VGS=-10V		20	26	mΩ
	RDS(on)2	ID=-4A, VGS=-4.5V		32	45	mΩ
	RDS(on)3	ID=-4A, VGS=-4V		36	51	mΩ
Input Capacitance	Ciss	VDS=-10V, f=1MHz		875		pF
Output Capacitance	Coss	VDS=-10V, f=1MHz		200		pF
Reverse Transfer Capacitance	Crss	VDS=-10V, f=1MHz		150		pF
Turn-ON Delay Time	td(on)	See specified Test Circuit.		8.1		ns
Rise Time	tr	See specified Test Circuit.		73		ns
Turn-OFF Delay Time	td(off)	See specified Test Circuit.		84		ns
Fall Time	tf	See specified Test Circuit.		74		ns
Total Gate Charge	Qg	VDS=-15V, VGS=-10V, ID=-8A		18		nC
Gate-to-Source Charge	Qgs	VDS=-15V, VGS=-10V, ID=-8A		2.1		nC
Gate-to-Drain "Miller" Charge	Qgd	VDS=-15V, VGS=-10V, ID=-8A		4.7		nC
Diode Forward Voltage	VSD	IS=-8A, VGS=0V		-0.82	-1.2	V

Switching Time Test Circuit

[N-channel]

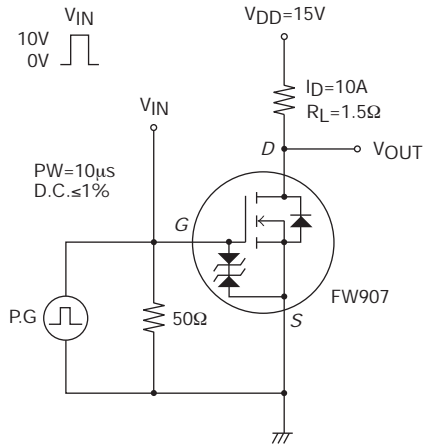

[P-channel]

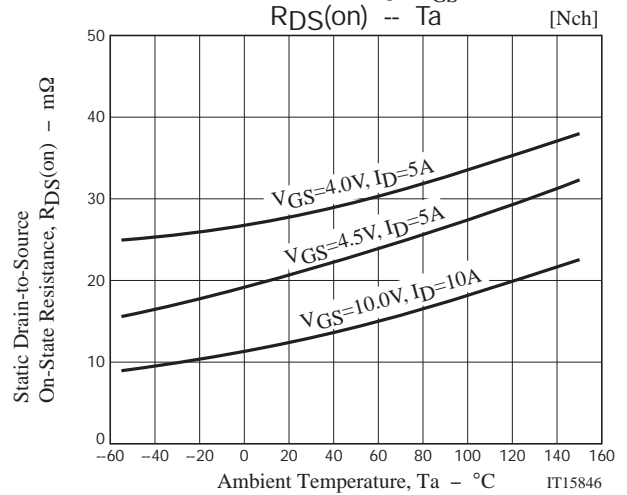
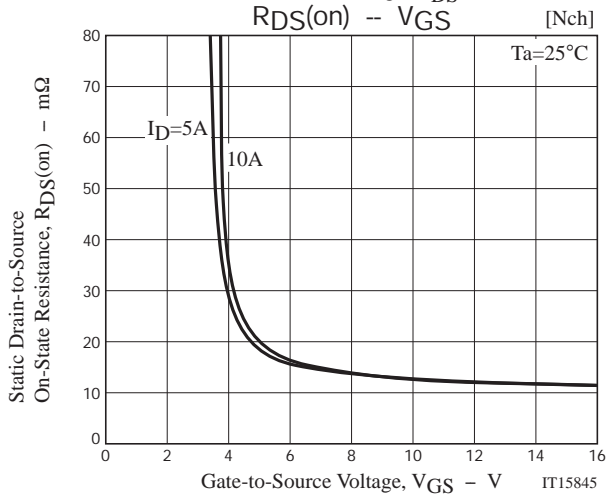
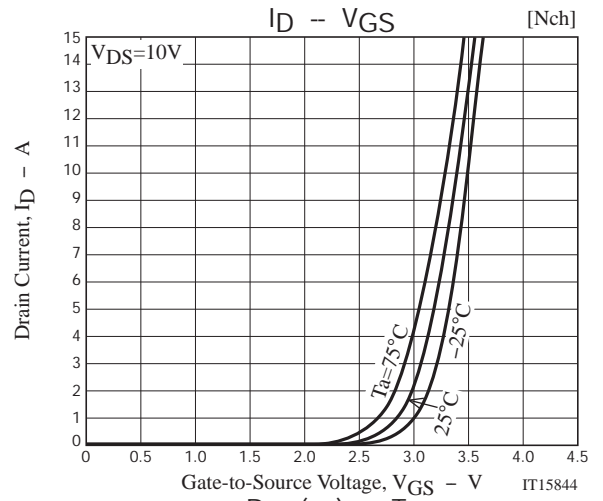
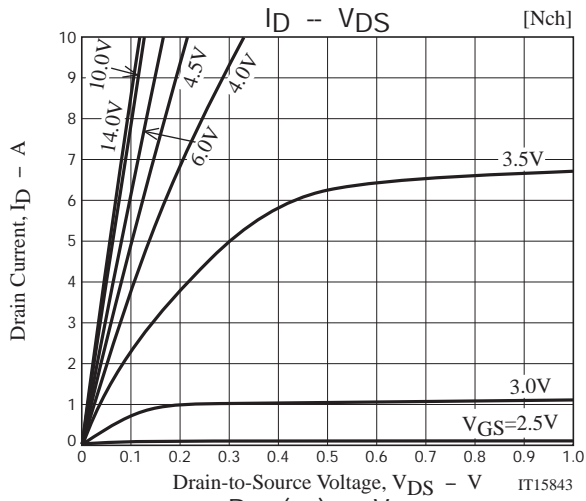
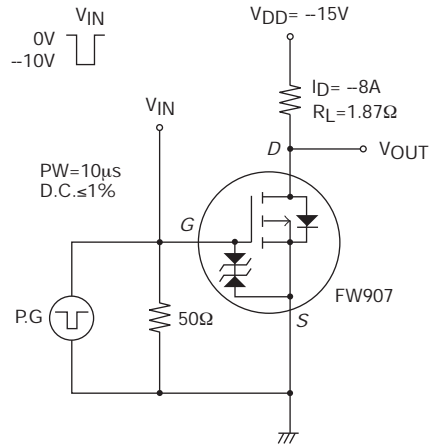

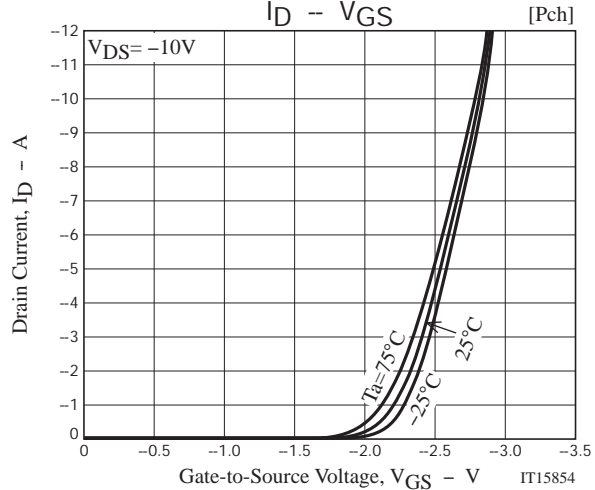
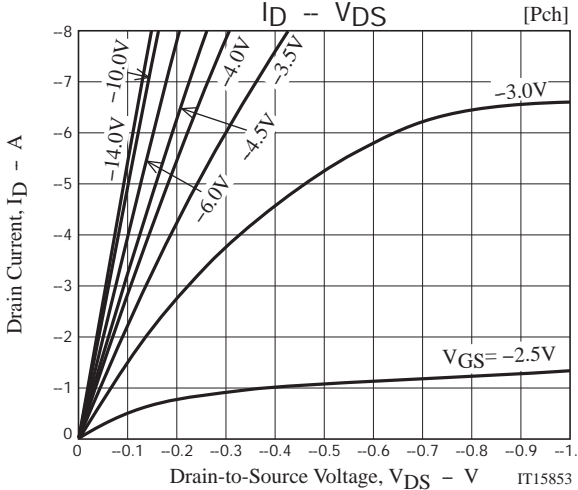
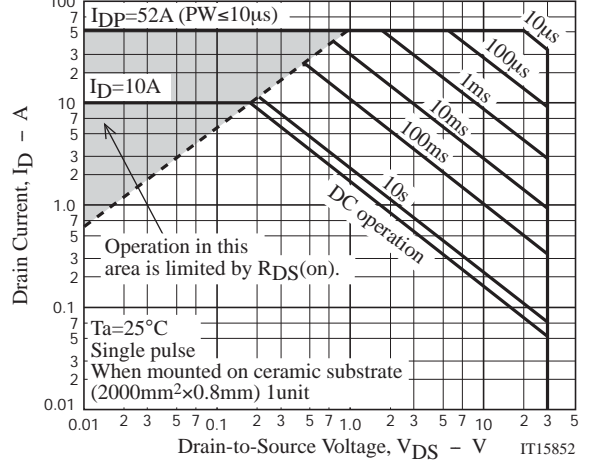
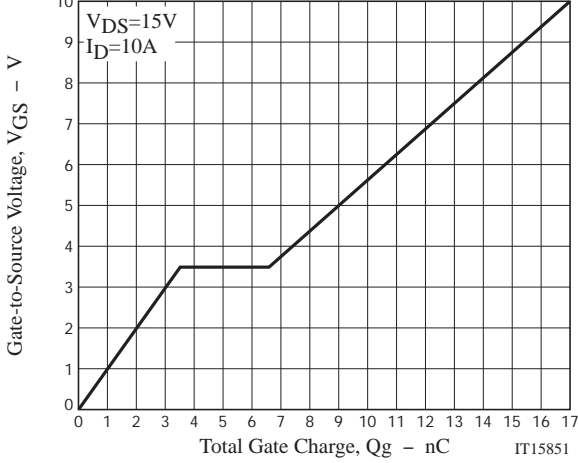
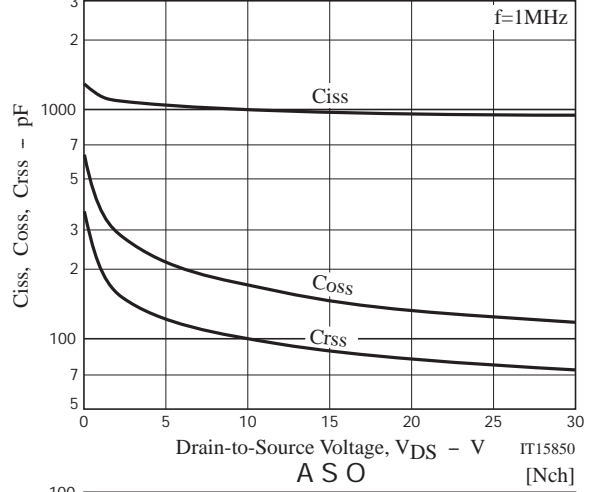
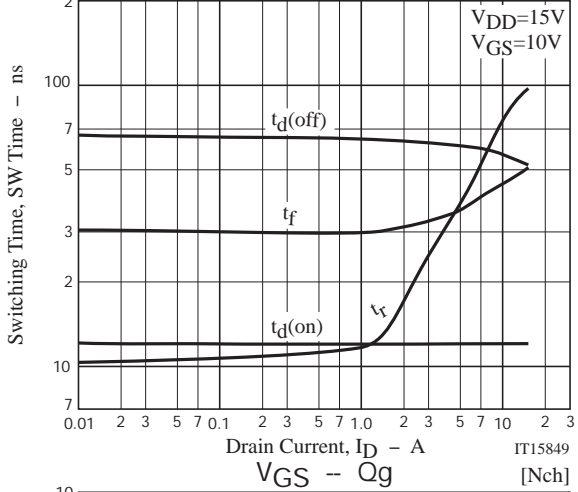
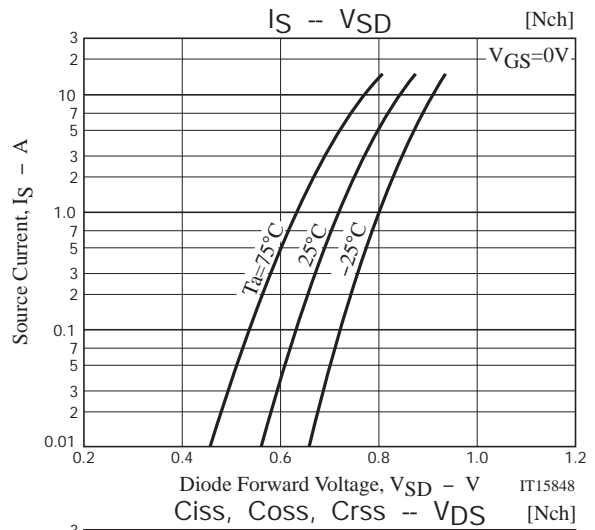
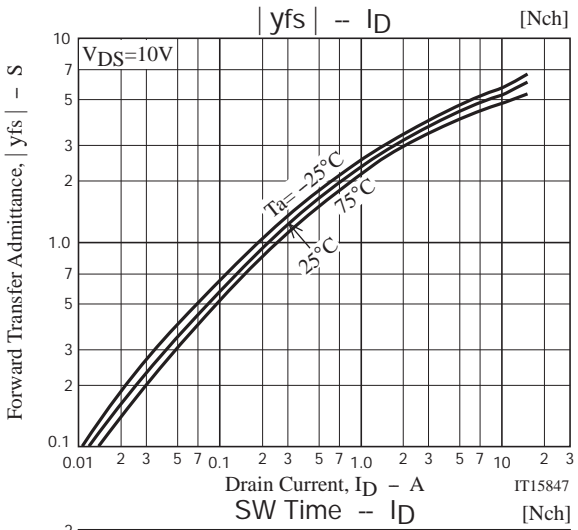

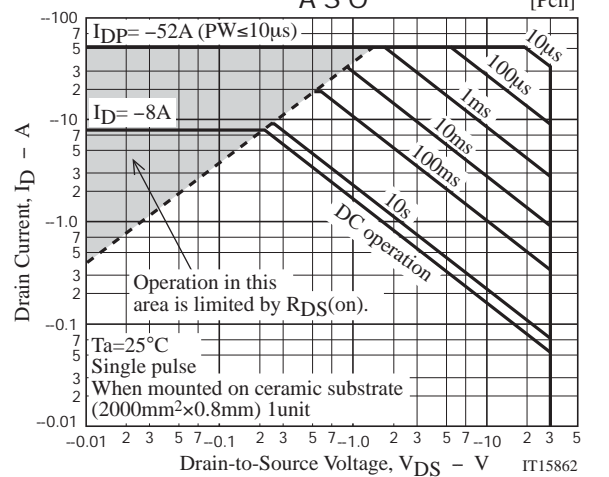
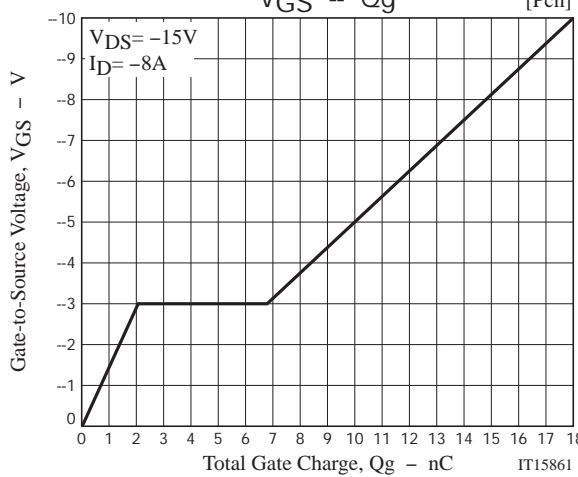
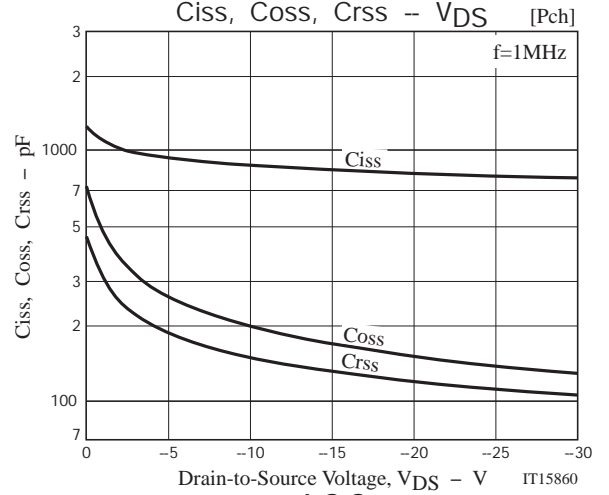
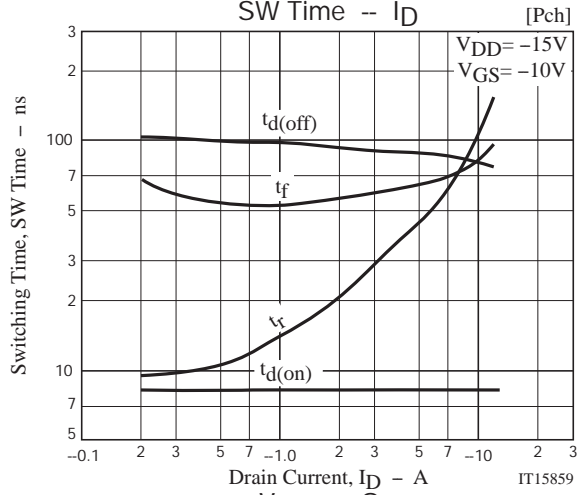
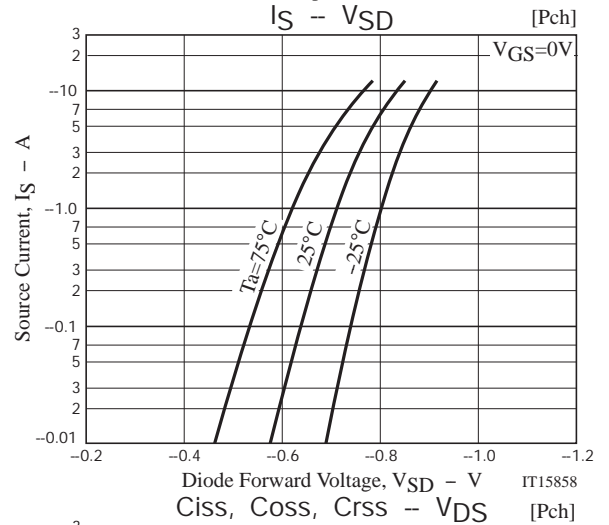
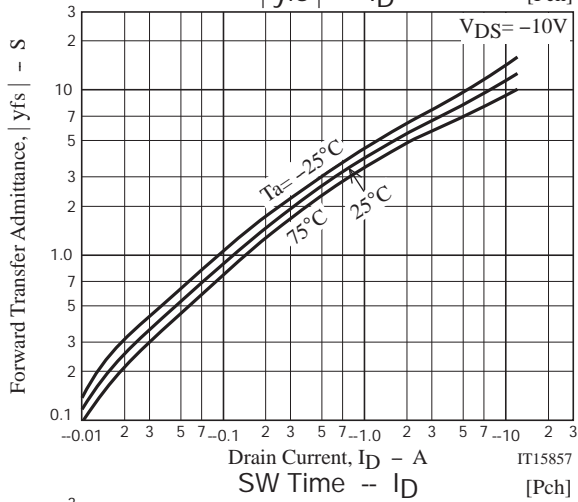
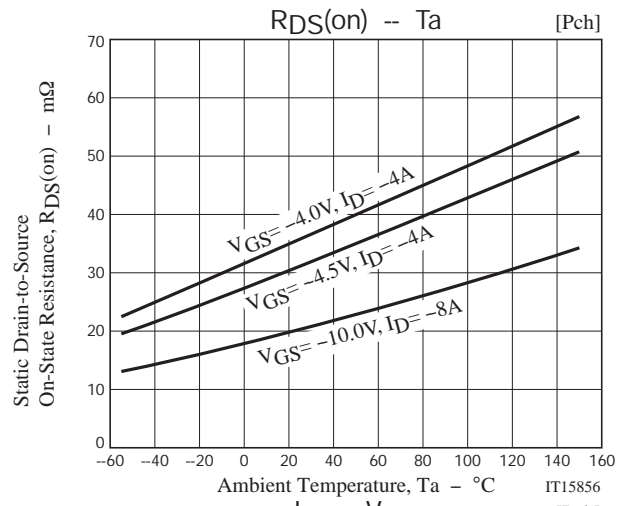
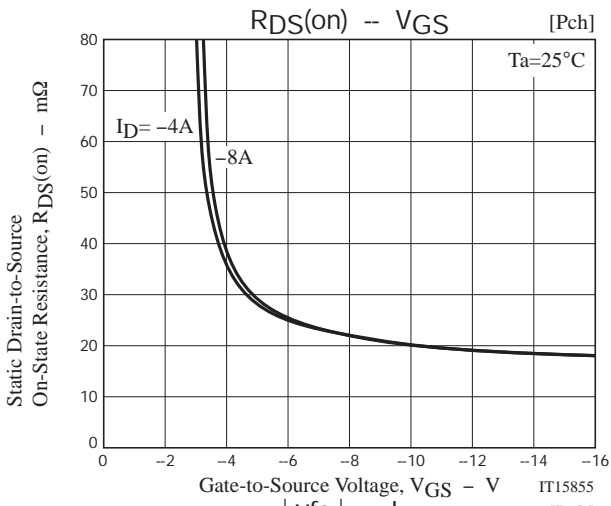

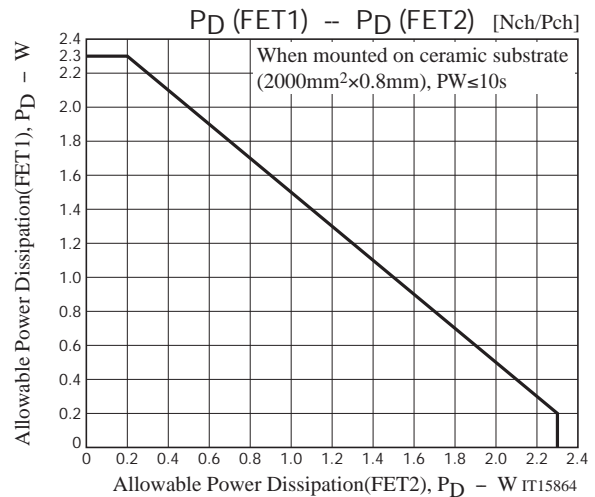
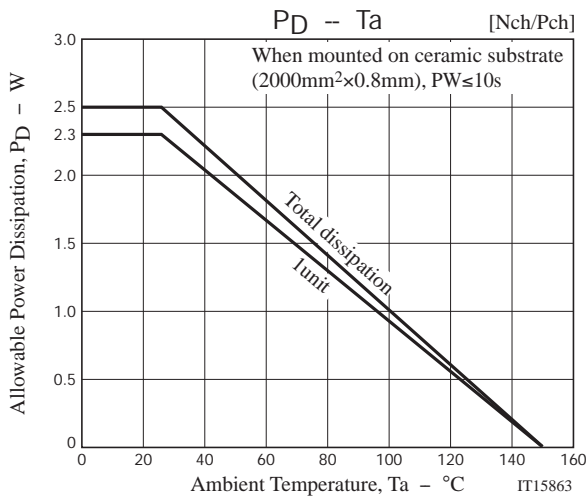

Note on usage : Since the FW907 is a MOSFET product, please avoid using this device in the vicinity of highly charged objects.

- Any and all SANYO Semiconductor Co.,Ltd. products described or contained herein are, with regard to "standard application", intended for the use as general electronics equipment (home appliances, AV equipment, communication device, office equipment, industrial equipment etc.). The products mentioned herein shall not be intended for use for any "special application" (medical equipment whose purpose is to sustain life, aerospace instrument, nuclear control device, burning appliances, transportation machine, traffic signal system, safety equipment etc.) that shall require extremely high level of reliability and can directly threaten human lives in case of failure or malfunction of the product or may cause harm to human bodies, nor shall they grant any guarantee thereof. If you should intend to use our products for applications outside the standard applications of our customer who is considering such use and/or outside the scope of our intended standard applications, please consult with us prior to the intended use. If there is no consultation or inquiry before the intended use, our customer shall be solely responsible for the use.
- Specifications of any and all SANYO Semiconductor Co.,Ltd. products described or contained herein stipulate the performance, characteristics, and functions of the described products in the independent state, and are not guarantees of the performance, characteristics, and functions of the described products as mounted in the customer's products or equipment. To verify symptoms and states that cannot be evaluated in an independent device, the customer should always evaluate and test devices mounted in the customer's products or equipment.
- SANYO Semiconductor Co.,Ltd. assumes no responsibility for equipment failures that result from using products at values that exceed, even momentarily, rated values (such as maximum ratings, operating condition ranges, or other parameters) listed in products specifications of any and all SANYO Semiconductor Co.,Ltd. products described or contained herein.
- SANYO Semiconductor Co.,Ltd. strives to supply high-quality high-reliability products, however, any and all semiconductor products fail or malfunction with some probability. It is possible that these probabilistic failures or malfunction could give rise to accidents or events that could endanger human lives, trouble that could give rise to smoke or fire, or accidents that could cause damage to other property. When designing equipment, adopt safety measures so that these kinds of accidents or events cannot occur. Such measures include but are not limited to protective circuits and error prevention circuits for safe design, redundant design, and structural design.
- In the event that any or all SANYO Semiconductor Co.,Ltd. products described or contained herein are controlled under any of applicable local export control laws and regulations, such products may require the export license from the authorities concerned in accordance with the above law.
- No part of this publication may be reproduced or transmitted in any form or by any means, electronic or mechanical, including photocopying and recording, or any information storage or retrieval system, or otherwise, without the prior written consent of SANYO Semiconductor Co.,Ltd.
- Any and all information described or contained herein are subject to change without notice due to product/technology improvement, etc. When designing equipment, refer to the "Delivery Specification" for the SANYO Semiconductor Co.,Ltd. product that you intend to use.
- Information (including circuit diagrams and circuit parameters) herein is for example only; it is not guaranteed for volume production.
- Upon using the technical information or products described herein, neither warranty nor license shall be granted with regard to intellectual property rights or any other rights of SANYO Semiconductor Co.,Ltd. or any third party. SANYO Semiconductor Co.,Ltd. shall not be liable for any claim or suits with regard to a third party's intellectual property rights which has resulted from the use of the technical information and products mentioned above.

This catalog provides information as of July, 2010. Specifications and information herein are subject to change without notice.