

Register your product and get support at
www.philips.com/welcome

User manual

使用説明



PHILIPS

CAUTION

Use of controls or adjustments or performance of procedures other than herein may result in hazardous radiation exposure or other unsafe operation.

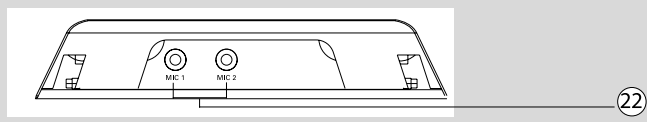
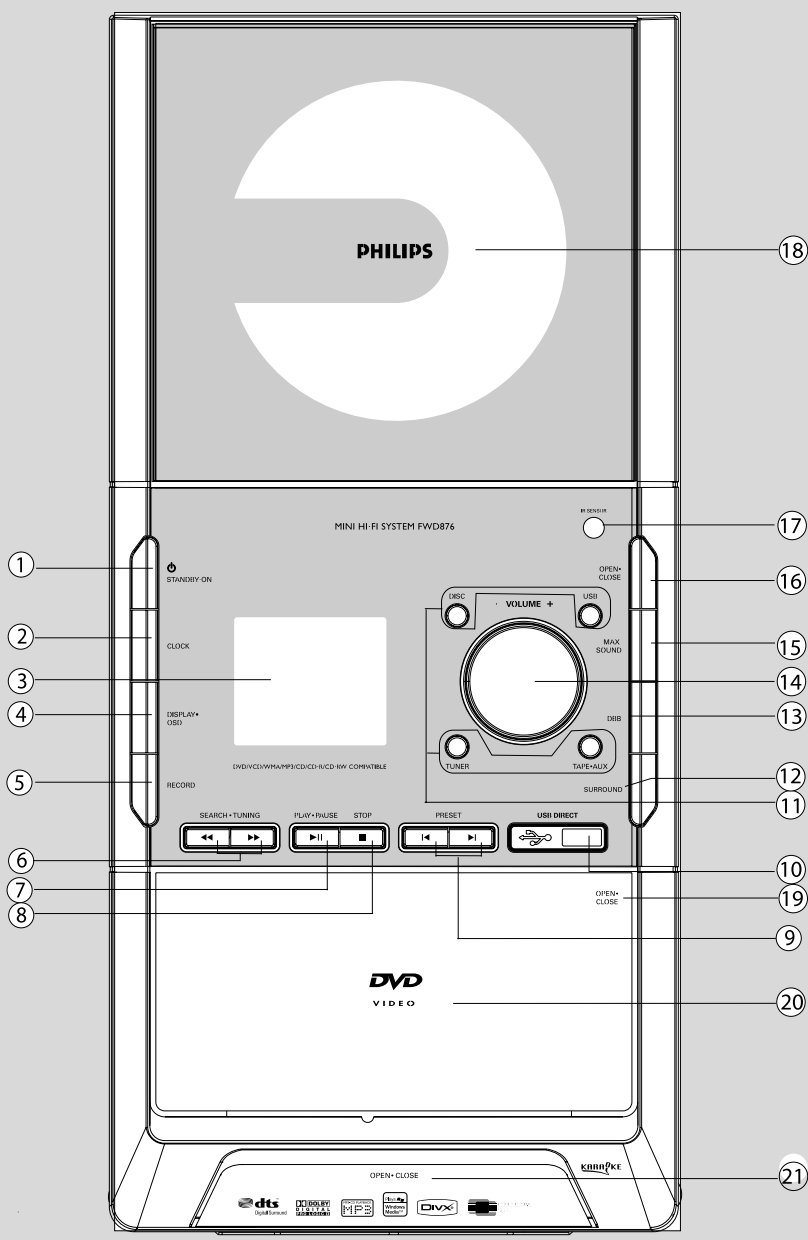



Manufactured under license under U.S. Patent #'s: 5,451,942; 5,956,674; 5,974,380; 5,978,762; 6,487,535 & other U.S. and worldwide patents issued & pending. DTS and DTS Digital Surround are registered trademarks and the DTS logos and Symbol are trademarks of DTS, Inc. © 1996-2007 DTS, Inc. All Rights Reserved.



Manufactured under license from Dolby Laboratories, Dolby, Pro Logic and the double-D symbol are trademarks of Dolby Laboratories .



Windows Media and the Windows logo are trademarks, or registered trademarks of Microsoft Corporation in the United States and/or other countries.

Windows Media is a trademark of Microsoft Corporation.



DivX Certified products: "DivX Certified, and associated logos are trademarks of DivX, Inc. and are used under license.

This product incorporates copyright protection technology that is protected by method claims of certain U.S. patents and other intellectual property rights owned by Macrovision Corporation and other rights owners. Use of this copyright protection technology must be authorized by Macrovision Corporation, and is intended for home and other limited viewing uses only unless otherwise authorized by Macrovision Corporation. Reserve engineering or disassembly is prohibited.

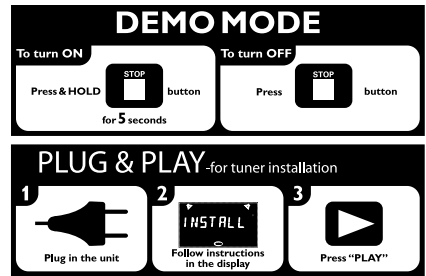

English -----6

中文----- 47

CONSUMERS SHOULD NOTE THAT NOT ALL HIGH DEFINITION TELEVISION SETS ARE FULLY COMPATIBLE WITH THIS PRODUCT AND MAY CAUSE ARTIFACTS TO BE DISPLAYED IN THE PICTURE. IN CASE OF 525 OR 625 PROGRESSIVE SCAN PICTURE PROBLEMS, IT IS RECOMMENDED THAT THE USER SWITCH THE CONNECTION TO THE 'STANDARD DEFINITION' OUTPUT. IF THERE ARE QUESTIONS REGARDING OUR TV SET COMPATIBILITY WITH THIS MODEL 525p AND 625p DVD PLAYER, PLEASE CONTACT OUR CUSTOMER SERVICE CENTER.

General Information/Maintenance

Features	8
Discs for playback	8
Region codes	8
Supplied accessories	8
Environmental information	9
Care and safety information	9

Connections

Step 1: Placing speakers and subwoofer	10
Step 2: Connecting Speakers and Subwoofer... ..	10
Step 3: Connecting TV set	11-12
Using Video In jack (CVBS)	
Using Line out jack(L/R)	
Using Component Video In jack (Pr Pb Y)	
Using S-Video In jack	
Using Headphone jack	
Using an accessory RF modulator	
Step 4: Connecting FM/MW antennas	13
Step 5: Connecting the power cord	13
Step 6: Connecting a VCR or cable/satellite box	14
Step 7: Connecting digital audio equipment .	14

Functional Overview

Basic function	15
Controls on the system	15
Remote control	16-17
Demonstration mode	17

Preparations

Step 1: Inserting batteries into the remote control	18
Step 2: Setting the TV set	18-19
Step 3: Setting language preference	19

Disc Operations

Playing discs	20
Using the disc menu	20
Basic playback controls	20
Skipping to another title (track)/chapter	
Fast search	
Continuing playback from the last stop point	
Selecting various modes	21-22
Repeat play / Shuffle play mode	
Repeating a section within a chapter/track	

Programming favorite tracks	22
Playing in slow motion mode	22
Special DVD/VCD features	23-24
Changing subtitle language	
Changing the pictures scales	
Changing sound track language	
Searching for a particular passage	
Displaying the disc information during playback	
Moving to another title / chapter	
Playing from a selected point	
Viewing from another angle	
Playback control (PBC)	
Checking the contents of DVD	

MP3/Picture/WMA/ Divx Disc

Operations

Playing MP3/WMA/Picture disc (Kodak, JPEG) ...	25
MP3/WMA/JPEG picture disc	25
Kodak picture disc	25
Playing a Divx disc	26

DVD Menu Operations

Using the menu (user preference settings).....	27
Setting the TV shape	28
Improving the image for progressive scan video output setting	29
Setting the screen saver	29
DivX (R) VOD Code.....	29
Night mode - turning on/off	30
Changing the password	30
Restricting playback by setting parental level	31
Divx Subtitle	31
Default	31

Tuner Operations

Tuning to radio stations	32
Presetting radio stations	32
Using auto install	32
Automatic preset programming	32
Manual preset programming	33
Selecting a preset radio station	33
Deleting a preset radio station	
Changing tuning grid	33

Tape Operation/Recording

Tape playback	34
General information on recording	34
Preparation for recording	35
Disc synchro recording	35

AUX Operations

Listening to an external source	36
---------------------------------------	----

Clock / Timer Operations

Viewing the clock.....	37
Setting the clock.....	37
Setting wake-up timer.....	37
Viewing the timer.....	37
Setting sleep timer.....	37

Sound and Volume Controls

Sound control	38
Selecting sound effect	
Selecting surround sound effect	
Selecting DBB effect	
Selecting MAX SOUND effect	
Volume control	38
Changing the volume level	
Switching off the volume temporarily	

USB Operations

Compatibility of the USB connection on this ...	
MINI HI-FI system	39
Supported Music type	39
Using a USB device	39
General information on USB device	39
USB playback	40

Other Functions

Dimming the display	41
Vocal	41
KARAOKE setup.....	41
Mic	
Mic Volume	
Echo level	
Key	
Score	
Karaoke	42

Specifications

43

Troubleshooting

44-45

Glossary

46

General Information/Maintenance

Features

Your DVD MINI HI-FI System with 5.1-channel full digital amplifier creates the same dynamic sound qualities that you find in full-fledged cinemas and incorporates some of the best features in home theater technology.

Other features include:

Additional Component Connections

Lets you connect other audio and audio/visual components to the system so you can use the system's speakers.

Night mode

Lets you compress the dynamic range, reducing the difference in loudness between different sounds in Dolby Digital mode.

Parental control (rating level)

Lets you set a rating level so that your children cannot watch a DVD that has a rating higher than you set.

Sleep timer

Enables the system to switch to standby mode automatically at a preset time.

Progressive Scan

Provides high quality flicker-free images for film based sources. When a picture refreshes, its vertical resolution can double to 525 lines.

Note:

– To fully enjoy the progressive scan feature, you need a progressive scan TV.

Discs for playback

Your DVD MINI HI-FI System will play:

- Digital Video Discs (DVDs)
- Video CDs (VCDs)
- Super-Video CDs (SVCDs)
- Digital Video Discs + Rewritable (DVD+RW)
- Compact Discs (CDs)
- Picture (Kodak, JPEG) files on CDR(W)
- Supported MP3-CD / WMA / DivX format.
- ISO 9660 / UDF format
- Max. title/album name –14 characters
- Max. title number plus album is 300.
- Max. nested directory is 8 levels.
- The max. MP3 track number is 648.
- Supported sampling frequencies for MP3 disc: 32 kHz, 44.1 kHz, 48 kHz.
- Supported Bit-rates of MP3 disc are: 32, 64, 96, 128, 192, 256 (kbps).

- Following formats can't be supported
- The files like *.VMA, *.AAC, *.DLF, *.M3U, *.PLS, *.WAV
- Non-English Album/Title name
- The discs recorded under Joliet format



Region codes

DVDs must be labeled for **ALL regions** or for **Region 3** in order to play on this system. You cannot play discs that are labeled for other regions.



Notes:

- For mixed mode discs, only one mode will be selected for playback according to the recording format.
- If you are having trouble playing a certain disc, remove the disc and try a different one. Improperly formatted discs will not play on this system.

Supplied accessories

- 1 Composite video cable (yellow)
- 1 Component video cables (red/blue/green)
- 1 Audio cables (white, red)
- 1 FM wire antenna
- 1 MW loop antenna
- 1 Remote Control & 2 AAA batteries
- 1 DIN OUT cable
- 2 AC Power cable
- This instruction booklet and a Quick Use Guide

About recycling

These operating instructions have been printed on non-polluting paper. The electronic equipment contains a large number of materials that can be recycled. If you are disposing of an old machine, please take it to a recycling center. Please observe the local regulations regarding disposal of packaging materials, exhausted batteries and old equipment.

Environmental information

Any unnecessary packaging has been omitted. We have tried to make the packaging easy to separate into three materials: cardboard (box), polystyrene foam (buffer) and polyethylene (bags, protective foam sheet).

--Your system consists of materials which can be recycled and reused if disassembled by a specialised company. Please observe the local regulations regarding the disposal of packaging materials, exhausted batteries and old equipment.

Care and safety information

Avoid high temperatures, moisture, water and dust

- Do not expose the system, batteries or discs to humidity, rain, sand or excessive heat (caused by heating equipment or direct sunlight). Always keep disc trays closed to avoid dust buildup on the lens.
- No objects filled with liquids, such as vases, shall be placed on the apparatus.
- No naked flame sources, such as lighted candles, should be placed on the apparatus.
- Battery shall not be exposed to excessive heat such as sunshine, fire or the like.

Avoid condensation problem

- The lens may cloud over when the player is suddenly moved from cold to warm surroundings, making it impossible to play a disc. Leave the player in the warm environment until the moisture evaporates.

Do not block the vents

- Do not operate the system in an enclosed cabinet and allow about 10 cm (4 inches) of free space all around the player for adequate ventilation.

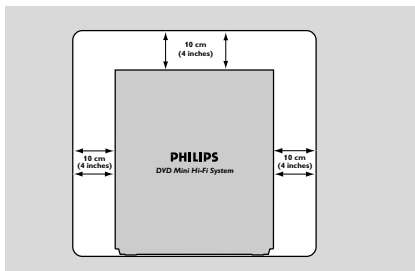

- The ventilation should not be impeded by covering the ventilation openings with items, such as newspapers table-cloths, curtains, etc.

Cleaning the cabinet

- Use soft cloth slightly moistened with a mild detergent solution. Do not use a solution containing alcohol, spirits, ammonia or abrasives.

Cleaning discs

- I To clean a CD, wipe it in a straight line from the center towards the edge using soft and lint-free cloth. A cleaning agent may damage the disc.
- Write only on the printed side of a CDR(W) and only with a soft felt-tipped pen.
 - Handle the disc by its edge. Do not touch the surface.



Cleaning the disc lens

- After prolonged use, dirt or dust may accumulate at the disc lens. To ensure good playback quality, clean the disc lens with Philips CD Lens Cleaner or any commercially available cleaner. Follow the instructions supplied with cleaner.

Finding a suitable location

- Place the player on a flat, hard, stable surface.

Cleaning the head and the tape paths

- To ensure good recording and playback quality, clean the head (A), the capstan(s) (B), and pressure roller(s) (C) after every 50 hours of tape operation.
- Use a cotton swab slightly moistened with cleaning fluid or alcohol.
- You also can clean the head by playing a cleaning tape once.

Demagnetising the head

- Use a demagnetising tape available at your dealer.

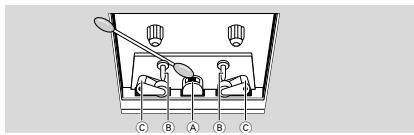

- Don't expose the system to dripping or splashing.
- Install this unit near the AC outlet and where the AC Power can be reached easily.
- When the system is switched to standby mode, it is still consuming some power. To disconnect the system from the power supply completely, remove the AC power plug from the wall sockets.
- Where the mains plug is used as the disconnect device, the disconnect device shall readily operable.

Connections

Step 1: Placing speakers and subwoofer

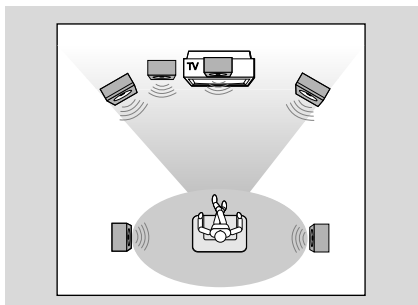

For best possible surround sound, all speakers (except subwoofer) should be placed at the same distance from the listening position .

- Retrieve the speaker grilles from the packing box and fix onto the active speakers as show below :

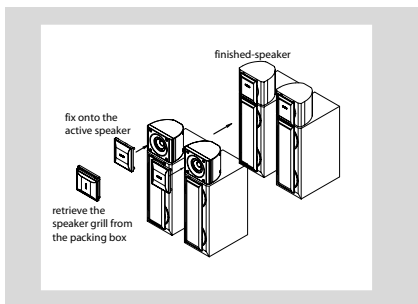

- Place the front left and right speakers at equal distances from the TV set and at an angle of approximately 45 degrees from the listening.
- place the center speaker above the TV set, so the center channel's sound is localized.
- Place the surround speaker at normal listening ear level facing each other or mounted on the set .
- Place the subwoofer on the floor near the TV set.

Notes:

- To avoid magnetic interference, do not position the front speakers too close to your TV set.
- Allow adequate ventilation around the DVD MINI HI-FI System.

IMPORTANT!

The type plate is located on the rear of the system.

To avoid overheating of the system, a safety circuit has been built in. Therefore, your system may switch to Standby mode automatically under extreme conditions. If this happens, let the system cool down before reusing it.

Step 2: Connecting Speakers and Subwoofer

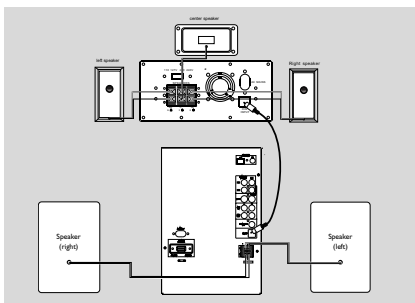

- Connect the speaker wires to the SPEAKERS (FRONT) terminals, right speaker to "R" and left speaker to "L", coloured (marked) wire to "+" and black (unmarked) wire to "-". Fully insert the stripped portion of the speaker wire into the terminal as shown.
- Connect the Surround Speakers and Center Speaker system using the supplied speaker cable to the speaker jacks on the SUBWOOFER by matching the colours of the jacks and speaker plugs.
- Connect the subwoofer using the supplied speaker cable to the DIN OUT jack on the DVD MINI HI-FI System.
- Connect the AC MAINS .

Speakers	⊖	⊕
Front Left (L)	Black	White
Front Right (R)	Black	Red
Center	Black	Green
Surround(rear) Left(L)	Black	Blue
Surround(rear) Right(R)	Black	Grey

Notes:

- For optimal sound performance, use the supplied speakers.
- Do not connect more than one speaker to any one pair of +/- speaker terminals.
- Do not connect speakers with an impedance lower than the speakers supplied. Please refer to the SPECIFICATIONS section of this manual.

Step 3: Connecting TV set

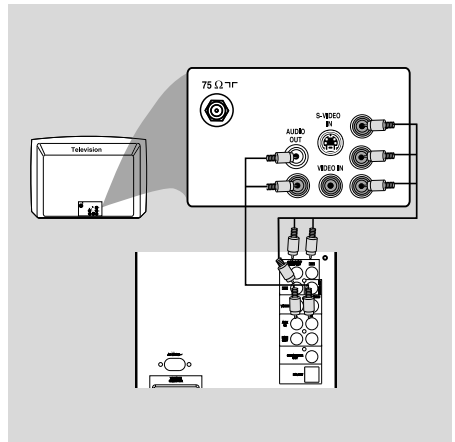
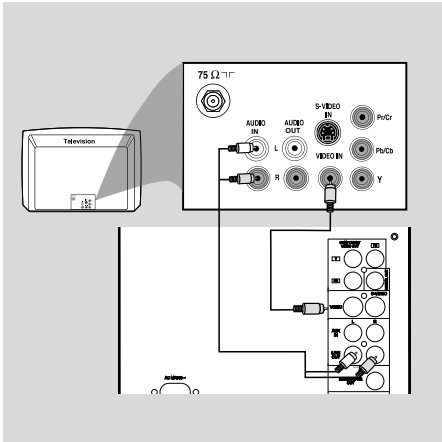

IMPORTANT!

- You only need to make one video connection from the following options , according to the capabilities of your TV system.
- **S-Video or Component Video connection provides higher picture quality.** These options must be available on your TV set.
- **Connect the system directly to the TV set.**

Using Video In jack (CVBS)

- Use the composite video cable (yellow) to connect the system's **VIDEO** jack to the video input jack (or labeled as A/V In, Video In, Composite or Baseband) on the TV set.

Using LINE OUT jack (L/R)

- To listen this system channels through TV , use the audio cables (white/red) to connect **LINE OUT (L/R)** jacks to the corresponding AUDIO IN jacks on the TV set.

Using component Video In jack (Pr Pb Y)

- Use the component video cables (red/blue/ green) to connect the system's **PR PB Y** jacks to the corresponding Component video input jacks (or labeled as Pr, Pb, Y or YUV) on the TV set.
- To listen this system channels through TV , use the audio cables (white/red) to connect **AUX IN (L/R)** jacks to the corresponding AUDIO OUT jacks on the TV set.
- If you are using a Progressive Scan TV set (TV with Progressive Scan or ProScan capability), activate the PROGRESSIVE SCAN function through SYSTEM MENU.

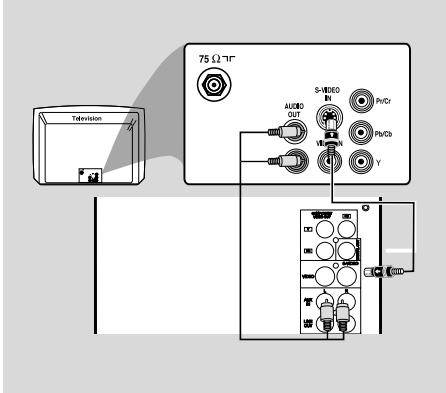

Using S-Video In jack

- Use the S-Video cable (not supplied) to connect the system's **S-VIDEO** jack to the S-Video input jack (or labeled as Y/C or S-VHS) on the TV set.
- To listen this system channels through TV, use the audio cables (white/red) to connect **AUX IN (L/R)** jacks to the corresponding AUDIO OUT jacks on the TV set

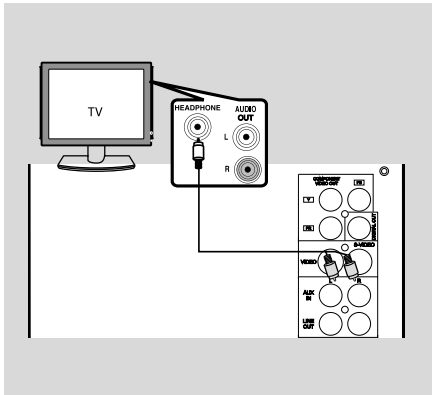

Using Headphone jack

- To listen to TV channels through this system, use the audio cables (white/red, not supplied) to connect **AUX IN (L/R)** jacks to the HEADPHONE jacks on the TV set (With a diameter 3.5mm stereo jack).

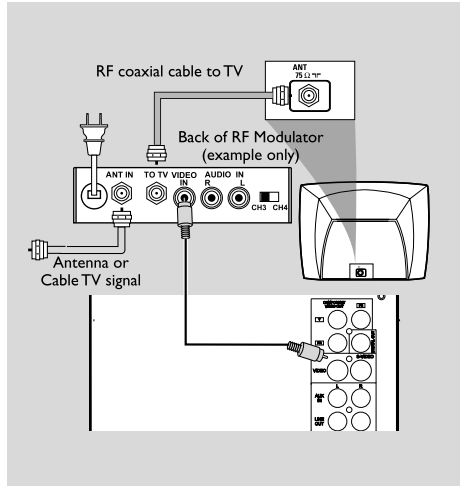

Using an accessory RF modulator

IMPORTANT!

– If your TV set only has a single Antenna In jack (or labeled as 75 ohm or RF In), you will need a RF modulator in order to view the DVD playback via TV. See your electronics retailer or contact Philips for details on RF modulator availability and operations.

- Use the composite cable (yellow) to connect the system's **VIDEO** jack to the video input jack on the RF modulator.
- Use the RF coaxial cable (not supplied) to connect the RF modulator to your TV's RF jack.

Step 4: Connecting FM/MW antennas

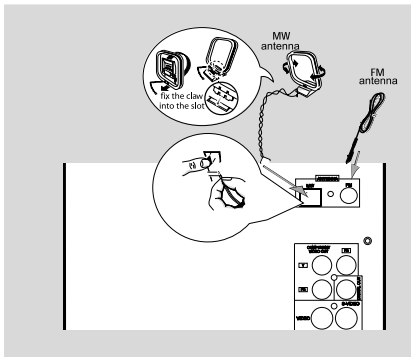

- Connect the supplied MW loop antenna to the **MW** jack. Place the MW loop antenna on a shelf or attach it to a stand or wall.
- Connect the supplied FM antenna to the **FM** jack. Extend the FM antenna and fix its end to the wall.

For better FM stereo reception, connect an outdoor FM antenna to the FM ANTENNA terminal.

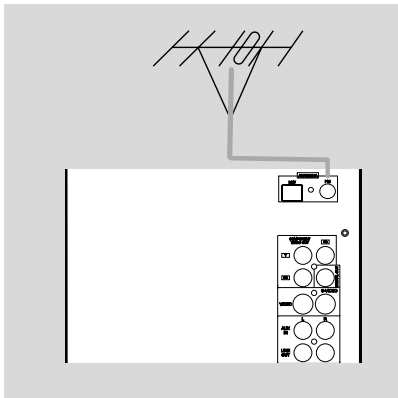

Notes:

- Adjust the position of the antennas for optimal reception.
- Position the antennas as far as possible from your TV set, VCR or other radiation sources to prevent unwanted interference.

Step 5: Connecting the power cord

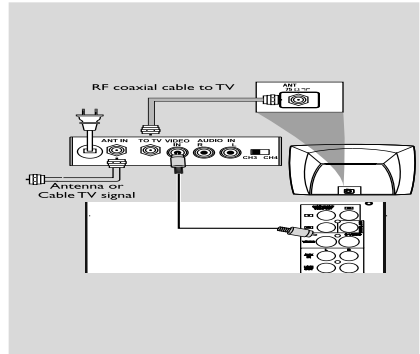

After everything is connected properly, plug in the AC power cord to the power outlet.

Never make or change any connection with the power switched on.

On the DVD MINI HI-FI System

"AUTO INSTALL PRESS PLAY" may appear on the display panel. Press **▶||** on the front panel to search and store all available radio stations or press **■** to exit.

If your system is equipped with a Voltage Selector; set the **VOLTAGE SELECTOR** to the local power line voltage.

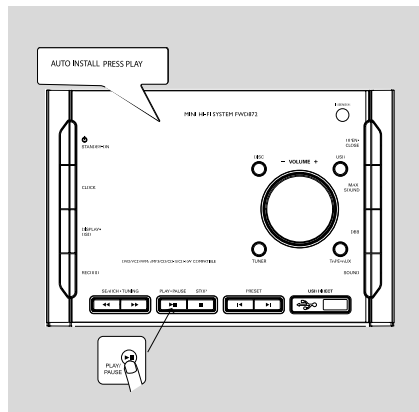
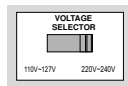

Step 6: Connecting a VCR or cable/satellite box

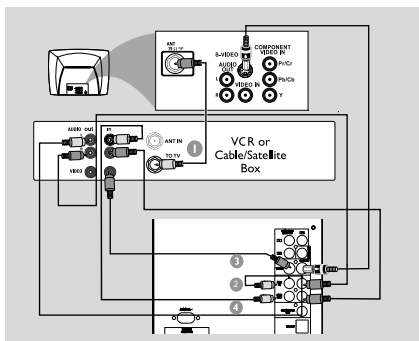

Viewing and listening to playback

- 1 Connect the VCR or Cable/Satellite Box to the TV system as shown.
- 2 Connect the system's **AUX IN** jacks to the AUDIO OUT jacks on the VCR or Cable/Satellite box.

Before starting operation, press **TAPE / AUX** on the remote control to select "AUX" in order to activate the input source.

Using the VCR for recording DVDs

Some DVDs are copy-protected. You cannot record or dub protected discs using a VCR.

- 3 Connect the system's **VIDEO** jack to the VIDEO IN jack on the VCR.
- 4 Connect the system's **LINE OUT (R/L)** jacks to the AUDIO IN jacks on the VCR. This will allow you to make analog stereo (two channel, right and left) recording.

To view DVD playback while recording

You must connect the system to your TV system using the S-VIDEO (as shown above) or the Component (Pr Pb Y) video connection.

Step 7: Connecting digital audio equipment

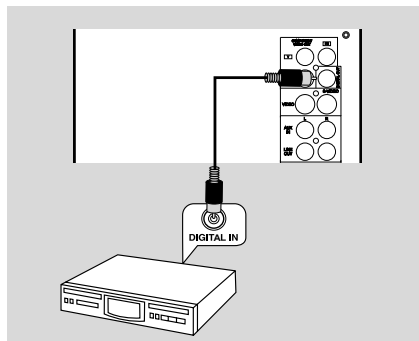

Recording(digital)

Connect the system's DIGITAL OUT jack to the DIGITAL IN jack on a digital recording device (DTS-Digital Theater System compatible, with a Dolby Digital decoder, for example).

Before operation, set the DIGITAL OUTPUT according to the audio connection.

Basic function



IMPORTANT!

Before you operate the system, complete the preparation procedures.



Switching the system on

- Press **STANDBY ON**  on the system
- Press **STANDBY ON, DISC, USB, TUNER** or **TAPE/AUX** on the remote control.
→ The system will switch to the selected source.

To switch the system to Eco-power standby mode

- In power-on mode, press briefly **STANDBY-ON**  (**STANDBY-ON**  on the remote).
→ Eco-power lamp  on the front panel will light up.
→ The VFD display will go blank.

Switching the system to Standby mode



- Press and hold **STANDBY ON**  on the system (or **STANDBY ON**  on the remote control) in the active mode.
→ The clock time will be displayed. Or "- : - : - -" will be displayed if clock time is not set.

Power-saving automatic standby

- As a power-saving feature, the system will automatically switch to standby mode if you do not press any buttons within 15 minutes after a disc or tape has stopped playing.

Controls on the system

Please refer page5 (front panel drawing)

- ① **STANDBY ON**
 - to switch the system on or to Eco-power Standby / Standby mode.
- ② **CLOCK**
 - to view or to set clock.
- ③ **DISPLAY SCREEN**
 - to view the current status of the system.
- ④ **DISPLAY OSD**
 - to view the time, title or chapter information.
- ⑤ **RECORD**
 - to start recording on tape deck .
- ⑥ **SEARCH•TUNING**  / 
 - for DISC/USB to search backward/forward.
 - for TUNER to tune to a lower or higher radio frequency.
 - for CLOCKto set the minutes.
- ⑦ **▶II (PLAY/PAUSE)**
 - for DISC/USB to start or interrupt playback.

for TAPE to start or interrupt playback.
for PLUG&PLAY ... (on the system only) to initiate plug & play mode.

- ⑧ **■ (STOP)**
 - for DISC/USB to stop playback or to clear a programme.
 - for Tuner..... to delete a preset radio station.
 - for TAPE to stop playback.
 - for DEMO (in Standby mode) to activate/deactivate demonstration.
 - for PLUG&PLAY ... (on the system only) to exit plug&play mode.
- ⑨ **◀▶ (PRESET)**
 - for DISC/USB to select previous/next title, chapter or track during playback.
 - for TUNER to select a preset radio station.
 - for CLOCK to set the hour.
- ⑩ **USB DIRECT**
 - to insert a USB device.
- ⑪ **SOURCE – to select the following: DISC**
 - to select disc.
- USB**
 - to select the USB.
- TUNER**
 - to select waveband: FM and MW.
- TAPE-AUX**
 - to select tape deck or to select a connected external source AUX (auxiliary).
- ⑫ **SURROUND**
 - to set various surround sound effects.
- ⑬ **DBB**
 - to set various sound effects.
- ⑭ **– VOLUME +**
 - to increase or decrease the volume.
- ⑮ **MAX SOUND**
 - to activate or deactivate MAX sound.
- ⑯ **OPEN•CLOSE**
 - to open or close the disc tray.
- ⑰ **IR SENSOR**
 - point the remote control towards this sensor.
- ⑱ **DISC TRAYS**
- ⑲ **OPEN.CLOSE**
 - to open or close the tape deck door.
- ⑳ **TAPE DECK**
- ㉑ **OPEN.CLOSE**
 - to open or close the microphone door.
- ㉒ **MIC IN 1 & MIC IN 2**
 - to connect microphone jack.

Functional Overview

Remote control

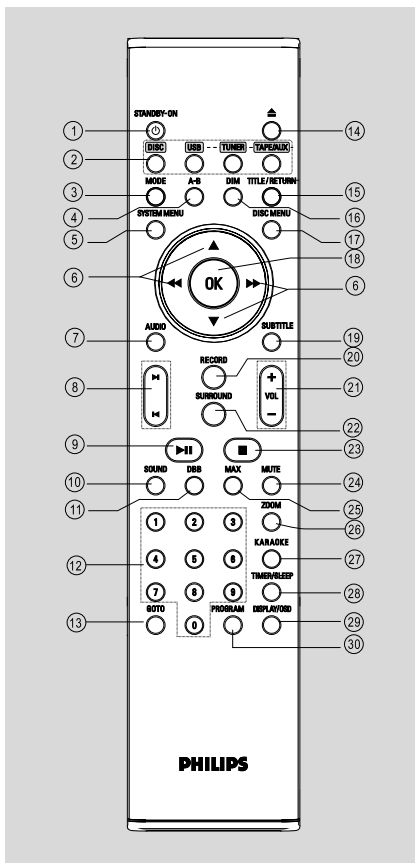

Notes:

- First, select the source you wish to control by pressing one of the source select keys on the remote control (DISC or TUNER, for example).
- Then select the desired function (▶▶, ◀◀ or ▶| for example).

① STANDBY-ON

- In power on mode, Press briefly to go to Eco-power mode; Press and hold to go to Standby mode .

② SOURCE

- to select the relevant active mode: DISC, USB , TUNER or TAPE/AUX.
- TUNER : toggles between FM and MW band.

③ MODE

- to select REPEAT or SHUFFLE function.

④ A-B

- to repeat a specific section in the same track/ chapter

⑤ SYSTEM MENU

- to enter or exit the system setup page.

⑥ ◀◀ / ▶▶ / ▲ / ▼

- to select movement direction in disc contents menu/system menu bar.
- in tuner mode, to tune to lower or higher radio frequency. (◀◀ / ▶▶)
- in Disc mode, press to fast reverse/forward the disc.(◀◀ / ▶▶)

⑦ AUDIO

- to select the audio channel.

⑧ ◀|/▶|

- in Disc /USB mode, press to skip to the previous/next chapter/track.
- in Tuner mode, to select a preset radio station number

⑨ PLAY/PAUSE P||

- to start or interrupt disc /USB/ tape playback.
- to resume playback from last stop point.

⑩ SOUND

- to select various sound effects.

⑪ DBB (Dynamic Bass Boost)

- to select the desired DBB level (DBB 1, DBB 2, DBB3 or DBB OFF).

⑫ Numeric Keypad (0-9)

- to enter a track/title/chapter number of the disc.
- to enter a number of preset radio stations.

⑬ GOTO

- to go directly to desired title, chapter; track or time.

⑭ ▲

- to open or close the disc tray.

⑮ TITLE /RETURN

- go back to title menu (for DVD only).
- go back to PBC menu page (for VCD/SVCD PBC ON).

⑯ DIM

- to select different brightness for VFD.

⑰ DISC MENU (disc /USB mode only)

- back to root menu (for DVD only)
- to switch on or off the playback control mode (for VCD/SVCD)
- toggle through File list, Folder, Playlist (for MP3/ WMA /DivX)

⑱ OK

- to exit or confirm the selection.

⑲ SUBTITLE

- to select desired subtitle.
- 20 **RECORD**
 - to start recording on tape deck .
- 21 **VOL +/-**
 - adjust the volume level.
- 22 **SURROUND**
 - to select various surround sound effects.
- 23 **STOP ■**
 - to stop playing the disc/USB/tape.
 - to delete a preset radio station.
- 24 **MUTE**
 - to interrupt or resume sound output.
- 25 **MAX**
 - To activate or deactivate MAX sound.
- 26 **ZOOM**
 - to access the zoom function.
- 27 **KARAOKE**
 - Allows user to enter or exit Karaoke Setup Page.
- 28 **TIMER/SLEEP**
 - to view and set timer or to set the sleep (auto-off) timer function.
- 29 **DISPLAY (OSD)**
 - to view the time, title or chapter information.
- 30 **PROGRAM**
 - in Disc / USB mode, to program favorite tracks.
 - in Tuner mode, press this button to start manual preset programming.
 - in Tuner mode, press and hold this button to start automatic preset programming.

Demonstration mode

The system has a demonstration mode that shows various features offered by the system.

This function allows you to display all function messages one by one on the VFD.

Activating demonstration

- In Standby mode , press and hold **STOP** key on the front panel for more than 5 seconds to activate demo mode.
 - "DEMO ON" is displayed.
 - Demonstration will begin.

Deactivating demonstration

- Press **STOP ■** on the system until "DEMO OFF" is displayed.
 - The system will switch to Standby mode.

Note:

– Even if you remove the AC power cord and reconnect it to the wall socket, the demonstration will remain off until you activate it again.

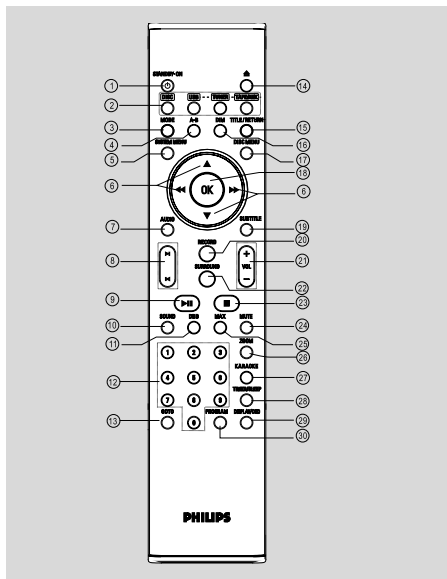

Preparations

IMPORTANT!

– Make sure to complete the preparation procedures before operating the system.

Step 1: Inserting batteries into the remote control

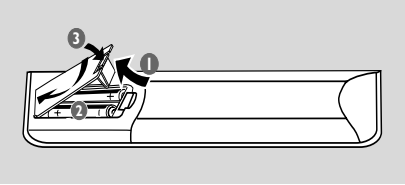

- ① Open the battery compartment.
- ② Place two batteries (Type LR03 or AAA) in the compartment with the correct polarity as indicated by “+” and “-” symbols.
- ③ Close the cover.

Using the remote control to operate the system

- 1 Point the remote control directly to the remote sensor (IR) on the front panel.
- 2 Select the source you wish to control by pressing one of the source selection buttons on the remote control (for example DISC,TUNER).
- 3 Then select the desired function (for example **▶||**, **◀|** or **▶|**).

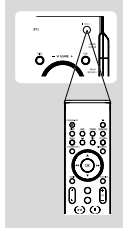

CAUTION!

- Remove batteries if they are exhausted or will not be used for a long time.
- Do not use old and new or different types of batteries in combination.
- Batteries contain chemical substances, so they should be disposed of properly.

Step 2: Setting the TV set

IMPORTANT!

– Make sure you have completed all the necessary connections.

- 1 Press **DISC** key on the front panel (or press **DISC** on the remote control).
- 2 Turn on the TV set and set to the correct Video-In channel. You should see the blue Philips DVD background screen on the TV set.
 - You may go to channel 1 on your TV set, then press the channel down button repeatedly until you see the Video In channel.
 - Or, you can use the TV remote control to select different video modes.
 - Or, set TV to channel 3 or 4 if you are using an RF modulator.

Selecting the color system that matches your TV set

This DVD MINI HI-FI System is compatible with both NTSC and PAL. For the playback of a DVD disc on this DVD MINI HI-FI System, the color systems of the DVD, TV set and DVD MINI HI-FI System should match.

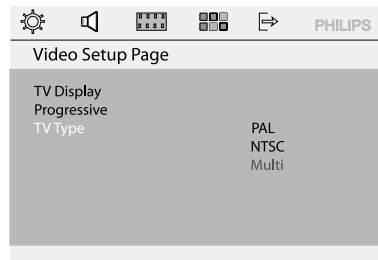

1 In DISC / USB mode ,press **SYSTEM MENU** on the remote control.

2 Press ◀◀ / ▶▶ / ▲ / ▼ keys on the remote control to select your preferred option.

- Move to "Video Setup Page" and press ▼.
- Move to "TV Type" and press ▶▶.

PAL

– Select this if the connected TV set is PAL system. It will change the video signal of an NTSC disc and output to PAL format.

NTSC

– Select this if the connected TV set is NTSC system. It will change the video signal of a PAL video disc and output to NTSC system.

Multi

– Select this if the connected TV set is compatible with both NTSC and PAL (multi system).The output format will be consistent with the video signal of the disc.

3 Select one of the options and press **OK** on the remote control to confirm.

- Read and follow the instructions shown on the TV to confirm the selection (if any).
- If a blank / distorted screen appears, please wait for 15 seconds for the auto recovery.

To remove the menu

Press **SYSTEM MENU**.

Step 3: Setting language preference

You can select your preferred language settings so that this DVD MINI HI-FI System will automatically switch to the language for you whenever you load a disc. If the language selected is not available on the disc, the language set by default will be used instead. But the menu language of the DVD MINI HI-FI System cannot be changed once selected.

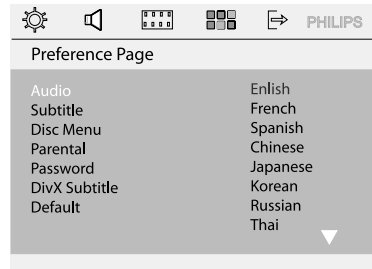

1 In disc mode, stop playback and press **SYSTEM MENU**.

2 Press ◀◀ / ▶▶ / ▲ / ▼ keys on the remote control to select your preferred option.

- Move to "Preference Page" and press ▼.
- Move to one of the following and press ▶▶.

- Audio (disc's soundtrack)
- Subtitle (disc's subtitles)
- Disc Menu (on screen menu)

3 Press ▲ / ▼ to select a language and press **OK**.

4 Repeat **steps 2~3** for other settings.

To remove the menu

Press **SYSTEM MENU**.

IMPORTANT!

- This system is designed for regular discs. Therefore, do not use any accessories such as disc stabiliser rings or disc treatment sheets, etc., as offered on the market, because they may jam the disc mechanism.
- Do not move the system during playback. Doing so may damage the system.
- Do not push on the disc tray or put any object other than disc on the disc tray. Doing so may cause the system to malfunction.
- DVD discs and players are designed with regional restrictions. Before playing a disc, make sure the disc matches the regional code of your player.
- According to the format requirement of DVD or VCD, some operations may be different or restricted.

Playing discs

- 1 Press **DISC** to select disc mode.
- 2 Power on the TV system and set to the correct Video In channel .
→ You should see the blue Philips DVD background screen on the TV set.
- 3 Press **OPEN/CLOSE** to open the disc tray and load a disc respectively.
→ Make sure the disc label is facing up. For double-sided discs, load the side you want to play facing up.

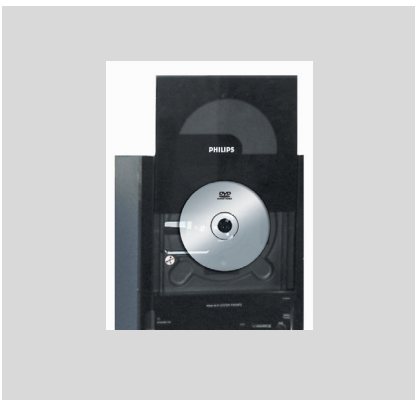

- 4 Press **OPEN•CLOSE** to close the disc tray.
→ "LOADING" will be displayed .
- Some discs can play automatically. For discs with Table Of Contents, a menu may appear on the TV screen. When the menu is displayed, press **◀ / ▶ / ▲ / ▼** keys to highlight your selection and press **OK** to confirm. To select a play option, press **numeric keys (0-9)**.
→ If the disc is locked by parental control, you must enter your six-digit password .
- 5 Press **▶II** to start playback.

For MP3/ DivX / WMA

- Load an MP3/DIVX/WMA disc in the disc tray.
→ Press **DISC MENU** to select File list , Folder or Playlist (if available).

Notes:

- Load discs with the label side facing up.
- To ensure good system performance, wait until disc reading is completed before proceeding.

Using the Disc menu

For disc with Table Of Contents, a menu may appear on the TV screen once you load the disc.

To select a playback feature or item

- Press **◀ / ▶ / ▲ / ▼** or **numeric keys (0-9)** on the remote control, then press **▶II** or **OK** to start playback.

To access or remove the menu

- Press **DISC MENU** on the remote control.

Basic playback controls

To start playback

- Press ►II.

To interrupt playback

- Press ►II.
- To resume playback, press ►II again.

To stop playback

- Press ■.

Skipping to another title (track) / chapter

For DVD/VCD

- During playback, press I◀ to skip to beginning of the current title (track) /chapter; press twice in 2 seconds to skip backward title (track) / chapter; press ►I to next title (track) / chapter:

For CD/MP3/JPEG/WMA/DivX

- Press I◀ or ►I on the front panel or on the remote control repeatedly during playback to skip to previous or next track.

Note:

- Each press will take the disc to the beginning of the previous or next title (track) / chapter.
- *If the player has been set to repeat chapter (track), pressing this button will replay the same chapter (track) from its beginning.*

To go directly to any title (track) / chapter

For CD/VCD/MP3/DivX/WMA

- Use the **numeric keys (0-9)** to enter the number of the desired track.

For DVD

- Please see "Moving to another title/chapter".

Fast search

- 1 Press ◀◀ or ▶▶ on the front panel (or on the remote control) to fast reverse or forward the disc.
- 2 To resume normal play, press ►II.

Continuing playback from the last stop point

- In Pre-stop mode and before the disc is removed, press ►II to resume playback from where you have stopped.

To cancel the resume mode

- Press ■ again, or go into **STANDBY** mode or press **OPEN/CLOSE** key.

Note:

– *Resume information will be erased if you have changed the disc, opened the disc tray, changed source or disconnected the system from the power supply.*

Selecting various modes

Repeat play / Shuffle play mode

You can only select the Repeat play and Shuffle play mode during playback for DVD/VCD/CD, but for MP3 / DivX / WMA , in stop / playback mode, you can also select Repeat play and Shuffle play mode.

For DVD - repeat chapter/title

- Press **MODE** repeatedly to select the following:
REPEAT CHAPTER → REPEAT TITLE → SHUFFLE →SHUFFLE REPEAT→REPEAT OFF

For SVCD/VCD/CD - repeat track/disc

- Press **MODE** repeatedly to select the following:
REPEAT TRACK → REPEAT ALL→SHUFFLE →SHUFFLE REPEAT→ REPEAT OFF

For MP3/WMA/DivX repeat - track/ album/disc

in Folder mode:

- Press **MODE** repeatedly to select the following:
REPEAT ONE → REPEAT ALL →SHUFFLE → FOLDER(REPEAT OFF)
- Press **MODE** repeatedly to select the following:
REPEAT ONE → REPEAT ALL →SHUFFLE → REPEAT OFF

In shuffle playback mode:

- Press I◀or ►I button to select another track in a shuffle order.

Disc Operations

To cancel Shuffle mode:

- Press **MODE** repeatedly to select "REPEAT OFF" mode.
Notes:
 - In *Tuner, Tape/Aux mode*, this button does not function.
 - When the disc tray is open, *Shuffle/Repeat function will be cancelled automatically.*
 - For *SVCD and VCD discs*, the Repeat function is not available when the *PBC function is set to "ON"*.

Repeating a section

You can play a specific section in a chapter/track repeatedly.

- 1 Press **A-B** at your chosen start point.
- 2 Press **A-B** again at your chosen end point.
→ The passage will now repeat continuously.
- 3 To resume normal play, press **A-B** again.

Note:

– The *REPEAT A-B function* can only be set within the same title or track.

Programming favorite tracks

You can play the contents of the disc in the order you want.

For DVD/VCD/SVCD/CD

- 1 Press **PROGRAM** on the remote control.
→ The programming menu appears.

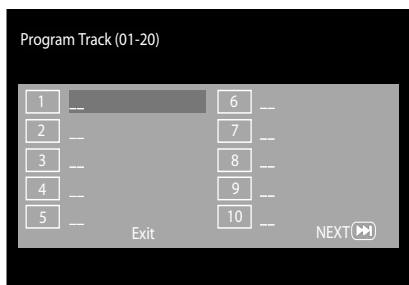

- 2 Use the **numeric keys (0-9)** to input the track (title) /chapter number in the order you want. (must enter two-digit, as 04)
→ If there are more than ten programmed tracks, select **{NEXT}** on the screen and press **OK** (or press **▶|** on the remote control) to access the next programming page.

- 3 Once complete, select **{Start}** on the screen and press **OK** to play the program.
- 4 To stop playback, press **■** once.
- 5 To exit the programming mode, select **{Exit}** in the menu and press **OK**
 - Or press **PROGRAM** on the remote control to exit the programming mode.

For MP3/JPEG/WMA

- 1 Press **▲ / ▼** to select a track/picture on the disc menu. then press **PROGRAM** to add the track/picture to playlist.
→ "Add To Playlist" will show on the disc menu.
- 2 Press **DISC MENU** repeatedly to select playlist menu.
- 3 Press **▲ / ▼** to select a track/picture and press **OK** to start playback.
→ In programming playlist, you can select a track/picture and press **PROGRAM** to move it
- 4 Press **STOP** to stop program playback .
- 5 Press **DISC MENU** to return to File list.

Notes:

– Most 20 tracks can be stored for DVD/VCD/SVCD/CD.
– Most 100 tracks can be stored for MP3/WMA/JPEG.

Playing in slow motion mode

For DVD

- 1 Press **▲ / ▼** repeatedly to select the required slow motion speed:
Press **▼** : **|▶ 1/2** → **|▶ 1/4** → **|▶ 1/8** → **|▶ 1/16**
→ **▶ (PLAY)**.....
Press **▲** : **◀| 1/2** → **◀| 1/4** → **◀| 1/8** → **◀| 1/16**
→ **▶ (PLAY)**.....
|▶ = slow forward
◀| = slow reverse

For VCD (only can select the slow forward)

- 2 Press **▼** to select the required slow motion speed:
|▶ 1/2 → **|▶ 1/4** → **|▶ 1/8** → **|▶ 1/16** →
▶ (PLAY).....
- 3 Press **▶||** to cancel the slow function.

Note:

– This function is not available for *CD, MP3, WMA or DivX discs.*

Special DVD/VCD features

Changing subtitle language

This operation only works on DVDs with multiple subtitle languages.

- Press **SUBTITLE** to select the desired language.

Changing the pictures scales

This operation only works on VCDs/DVDs/ JPEGs / DivXs with images.

For VCD/DVD/DIVX:

- Press **ZOOM** to change the zooming scale:
ZOOM X2 → ZOOM X3 → ZOOM X4
→ ZOOM X1/2 → ZOOM X1/3 → ZOOM
X1/4 → (ZOOM OFF)...

For JPEG:

- Press **ZOOM** to change the picture zooming scale:
ZOOM X100% → ZOOM X125% → ZOOM
X150% → ZOOM X200% → ZOOM X75%
→ ZOOM X50% → (ZOOM OFF)...
- To pan through the enlarged image, press ◀ / ▶ / ▲ / ▼ buttons to move the zoomed picture left, right, up or down.
- Press **ZOOM** repeatedly to exit ZOOM mode.

Changing sound track language

This operation only works on DVDs / VCDs with multiple audio languages.

For DVD:

- Press **AUDIO** to select the desired language.

For VCD:

- Press **AUDIO** to select the desired audio channels for sound.
MONO LEFT → MONO RIGHT →
MIX-MONO → STEREO

Note:

– If your desired language is not set in the disc, you cannot select the language via this function.

Searching for a particular passage

- 1 Press ◀◀ or ▶▶ on the remote control to select fast reverse search or fast forward search respectively.
- 2 Press ◀◀ or ▶▶ on the remote control repeatedly to select the required search speed:
(forward): ▶▶ 2X → ▶▶ 4X → ▶▶ 8X →
▶▶ 16X → ▶▶ 32X → (PLAY)..
(reverse): ◀◀ 2X → ◀◀ 4X → ◀◀ 8X →
◀◀ 16X → ◀◀ 32X → (PLAY)...

Displaying the disc information during playback

- In disc mode, press **DISPLAY/OSD** repeatedly to select the following display information:



Menu	
Track	11/16
Disc Time	1:16:05
Track Time	0:04:05
Repeat	Off
▼	
Bitrate 75	Total Elapsed 0:55:11

Moving to another title/chapter

Some discs may contain more than one title or chapter. If the disc has a title or chapter menu recorded on it, you can start playback from the selected item.

- 1 Press **DISPLAY/OSD** on the remote control to display the message of title and chapter.
- 2 Use ▲ / ▼ to highlight an item and press **OK**
- 3 Use **numeric keys (0-9)** to select a desired title/chapter number.
- 4 Press **DISPLAY/OSD** to exit the disc information menu.

Note:

– Selecting a title or chapter might not be possible on certain discs.

Disc Operations

Playing from a selected point

This function allows you to start playback at any chosen time on the disc.

For DVD

- 1 Press **GOTO** to activate time menu, the TV screen will display:
Title:XX/XX Chapter:_/XX
Title:XX/XX Time _:__:__
Chapter:XX/XX Time _:__:__
→ You can press **◀ / ▶** to highlight the title item and use the numeric keys to select desired title.

- 2 Enter hours, minutes and seconds from left to right in the time edit box using the **numeric keys (0-9)**.

For SVCD, VCD or CD

- 3 Press **GOTO** to activate time menu, the TV screen will display:
Disc Go to: _: _: __
Track Go to: _: _: __
Select Track : _/XX
- 4 Enter minutes and seconds from left to right in the time edit box using the **numeric keys (0-9)**, then it will start playback.

For MP3 / Divx / WMA

- 5 Press **GOTO** and use **numeric keys (0-9)** to enter your choice to playback.

Note:

– In repeat disc or repeat all mode, you can search a desired time point.

Viewing from another angle

If the playing DVD disc is recorded with multiple camera angles, This allows you to view the picture from different angles. Angle selection is determined by the disc format.

- 1 Press **DISPLAY/OSD** to display the disc message.
- 2 Use **▲ / ▼** to highlight "Angle" and press **OK**
- 3 Use **numeric keys (0-9)** to select a desired angle.
→ Playback changes to the selected angle.

Playback control (PBC)

PBC allows you to play Video CD interactively, following the menu on the display.

- Press **DISC MENU** to toggle between PBC ON and PBC OFF.

Playing a disc with PBC function

- If PBC OFF, the system will start playback automatically.
- If PBC ON, the PBC menu (if available) will appear on the TV screen for selection. Use the **numeric keys (0-9)** to enter your choice.

Note:

– This function is not available for DVD/CD/MP3/WMA/Divx discs.

Checking the contents of DVD

- 1 Press **DISC MENU** on the remote control.
→ If the current title has a menu, the menu will appear on the screen. Otherwise, the disc menu will be displayed.
- 2 Press **◀ / ▶ / ▲ / ▼** to select the desired title or chapter, and then press **▶II** or **OK**.
→ Playback start from the selected title or chapter.
- 3 Press **DISC MENU** on the remote control to go to disc menu of the disc.

Note:

– If no title menu or root menu is recorded in the DVD disc, pressing this button will restart playback from the first track.

Playing MP3/WMA/Picture disc (Kodak, JPEG)

IMPORTANT!

– You have to turn on your TV set and set to the correct Video In channel.

MP3/WMA/JPEG Picture disc

- 1 Load an MP3/WMA/Picture (JPEG) disc.
→ The disc reading time may exceed 30 seconds due to complexity of the directory/file configuration.
→ the disc menu will appear on the TV.
- 2 Select a track in the menu and press **OK** to start playback

(MP3 disc menu)

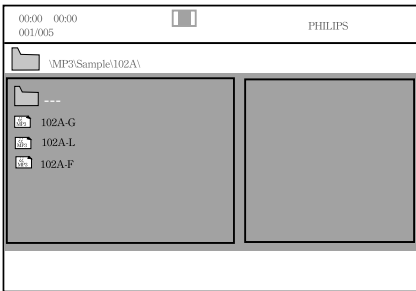

- 3 During music playback, press **▲** / **▼** or use the **numeric keys (0-9)** to select a desired picture file from the disc menu and press **OK**.
- 4 → If the disc main menu contains various folders, use **▲** / **▼** to select a desired folder; and press **OK** to open the folder.
- 5 Press **◀** or **▶** on the system to select previous / next track.
- 6 To stop simultaneous playback, press **DISC MENU** followed by **STOP**.
- 7 During JPEG or Kodak Picture disc playback, press **PROGRAM** repeatedly to select different scan effects. There are 12 types of scan effect for selection. The selected scan effect will be displayed on the TV screen.

Kodak Picture disc

- 1 Load a Kodak Picture disc.
→ The disc reading time may exceed 30 seconds due to complexity of the directory/file configuration.
- 2 During playback, press **■**.
→ 12 thumbnail pictures will appear on the TV screen.

(example for picture disc menu)

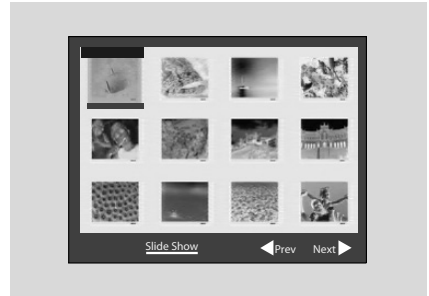

- 3 Press **◀** or **▶** to view the previous/next page (if available).
- 4 Press **◀◀** / **▶▶** / **▲** / **▼** to move within the menu and press **OK** to select the desired picture to play.
- 5 Press **PROGRAM** to select different slide-show playback modes.

During playback, you can:

- Press **◀** or **▶** to select another track/picture in the current folder.
- Press **◀◀** / **▶▶** / **▲** / **▼** on the remote control to rotate or flip the picture files.
- Press **ZOOM** repeatedly to zoom in and out the picture.
- Press **⏸** to pause/resume playback.

Notes:

- Due to the recording nature of Digital Audio MP3 (DAM), only digital audio music will play.
- It is normal to experience an occasional “skip” while you are listening to your MP3 discs.
- For multi-session discs with different formats, only the first session can be read and played.

MP3/ Picture/WMA/Divx Disc Operations

Playing a Divx disc

This unit supports the playback of Divx movies which you can copy from your computer onto a recordable disc.

- 1 Insert a Divx disc,
- 2 Press ◀◀ / ▶▶ / ▲ / ▼ keys to navigate to the title you want to play.
- 3 Press **PLAY** or **OK** key to start playback..

During playback:

- If the Divx has multilingual subtitles,, you can press **SUBTITLE** on the remote control to change the subtitle language.
- If the Divx has different audio tracks, you can press **AUDIO** on the remote control to change the audio stream.
- Use ◀◀ / ▶▶ keys on the remote control to perform fast reverse /forward search.
- Press **GOTO** and use **numeric keys (0-9)** to enter your choice to playback. Key in the time where playback should start.

To access or remove the menu

- Press **DISC MENU** on the remote control again.

Helpful Hints:

- Subtitle files with the following file name extensions (.srt, .smi, .sub, .ssa, .ass) are supported but do not appear on the file navigation menu.
- The subtitle file name has to be the same as the file name of the movie.
- The subtitle can only be displayed up to an average of 45 characters.

Using the menu (user preference settings)

This DVD setup is carried out via your TV set, enabling you to customize the DVD MINI HI-FI System to suit your particular requirements.

- In disc mode, press **SYSTEM MENU**.
→ The setup menu will appear on the TV screen.
- Use **◀ / ▶** keys to select one of the setup menu options and press **OK**.

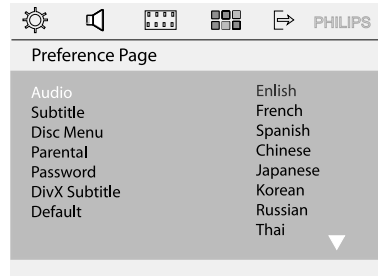
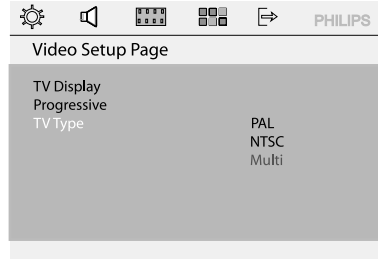
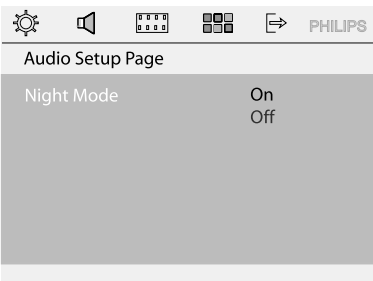
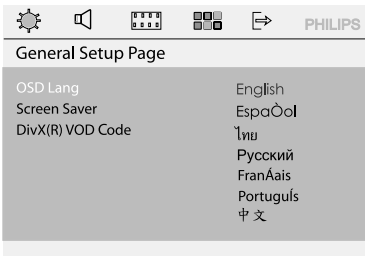

- Press **▲ / ▼ / ◀ / ▶** /on the remote control to navigate in the menu.
- Press **OK** to confirm your selection.

Removing the menu

Press **SYSTEM MENU** again.

Note:

- When the disc is under playing, "preference page" can't be entered, you need to press **STOP** button twice, then press **SYSTEM MENU** to enter "preference page".

DVD Menu Operations

Setting the TV shape

Make sure the format you need is available on the disc. If not, your setting will be invalid.

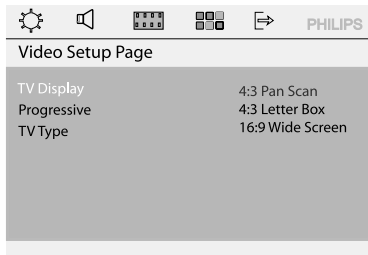

4:3 Pan Scan

Select this if you have a conventional TV set and your DVD is not formatted for wide screen viewing. A wide picture will display on the whole TV screen with a portion automatically cut off.

4:3 Letter Box

Select this if you have a conventional TV set and your DVD is formatted for wide screen viewing. Black bars appear on the upper and lower portions of the TV screen.

16:9 Wide Screen

Select this if you have a wide-screen TV set (you must also set your wide screen TV to "full size").

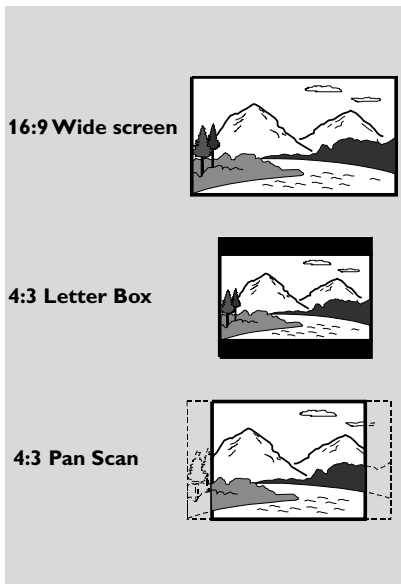

DVD Menu Operations

Improving the image for progressive scan video output setting

This feature is only applicable when you have connected this system to a Progressive Scan TV system through the Component Video jack

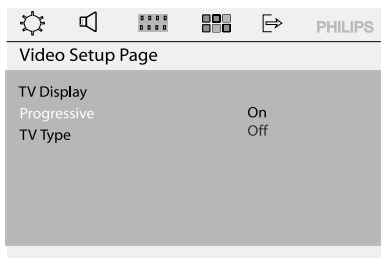

Off

Select this if a conventional TV set is connect to yor system.

On

To enjoy the full quality potential offered by progressive scan feature, a progressive scan TV set is required.

- 1 Move to "Progressive", select "On" in the menu and press **OK** to confirm.

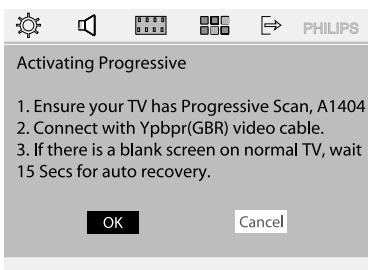

- 2 Read the notification message shown on the TV and confirm your action by selecting the " **OK** " in the menu and press **OK**
 - If a blank / distorted screen appears, please wait for 15 seconds for the auto recovery.
- Otherwise , select " **Cancel** " and press **OK** to go back to the previous menu.

There will be no picture on your TV at this state until you have turned on the progressive scan mode on your TV.

- 3 Turn on your TV progressive scan mode (refer to your TV's user manual).
 - **A message appears on the TV.**
- 4 Confirm your action by selecting the " **OK** " in the menu and press **OK**
 - **The setup is now completed and you can start to enjoy the high quality picture.**

Setting the screen saver

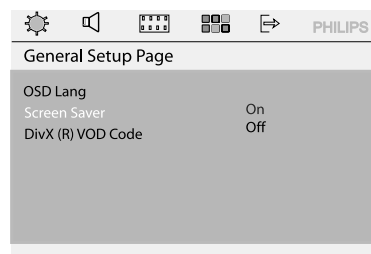

If Screen Saver set to On, the screen saver will be activated when you leave the system in stop or pause mode for 5 minutes. The default setting is "On".

DivX (R) VOD Code

Philips provide you the DivX(R) VOD (Video On Demand) registration code that allows you to rent or purchase videos from the DivX(R) VOD service at www.divx.com/vod.

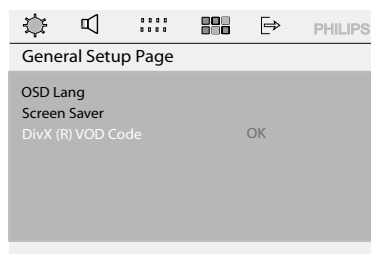

Read and follow the instruction shown on the TV and download the video onto a CD-R for playback on this system.

Helpful Hint:

- *All the download videos DivX(R) VOD can only be played back on this system.*

DVD Menu Operations

Night mode - turning on/off

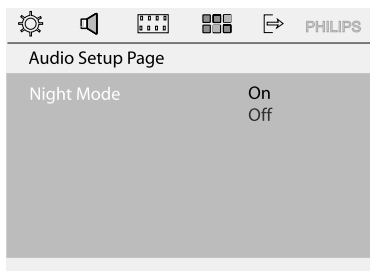

Off

Select this when you want to enjoy the surround sound with its full dynamic range.

On

Select this to level out the volume. High volume output will be softened and low volume output will be brought upward to an audible level. This feature is only available for movies with Dolby Digital mode.

Changing the password

You can change the six-digit code used as Password.

- 1 In DISC / USB stop mode, press **SYSTEM MENU** key on the remote control.
- 2 Press **◀ / ▶ / ▲ / ▼** on the remote control to navigate in the menu.

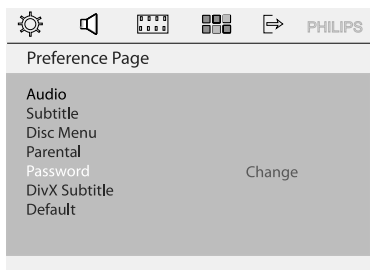

- Move to "Preference Page" and press **▼**.
- Move to "Password" and press **▶▶**.
- Press **OK**.

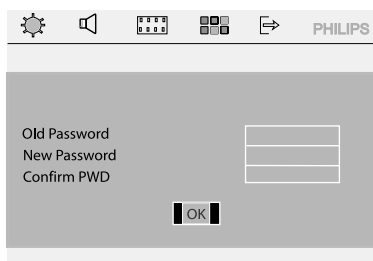

- The TV screen will display below picture
- 3 Use the **numeric keys (0-9)** to enter your six-digit code.
 - The password supplied by default is 000000.
 - If you forget the six-digit code, press "136900" to set password.
 - Go to "Password" and enter your new code. Then, enter the same code again to confirm.
 - 4 Press **SYSTEM MENU** again to remove the menu.

Restricting playback by setting parental level

Some DVDs may have a parental level assigned to the complete disc or to certain scenes on the disc. This feature lets you set a playback limitation level. The rating levels are from 1 to 8 and are country specific. You can prohibit the playing of certain discs that are not suitable for your children or have certain discs played with alternative scenes.

- 1 In disc stop mode, press **SYSTEM MENU**.
- 2 Use **◀◀ / ▶▶ / ▲ / ▼** on the remote control to navigate in the menu.
 - Move to "Preference Page" and press **▼**.
 - Move to "Parental" and press **▶▶**.

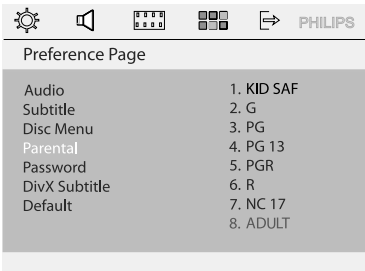

- 3 Press **▲ / ▼** to select a rating level between 1-8 and press **OK**.
 - DVDs rated above the level you select will not play unless you enter your six-digit password or choose a higher level rating.
- 4 Use the **numeric keys (0-9)** to enter the six-digit code, and press **OK**.

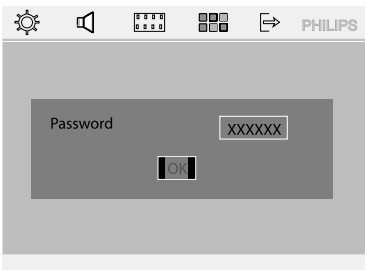

- 5 Press **SYSTEM MENU** again to remove the menu.

Rating explanations:

8 ADULT – material for adults only; viewed only by adults due to graphic sexual scenes, violence, or language.

7 NC-17 – No children under age 17; not recommended for children under age 17.

5-6 PG-R – Parental Guidance – Restricted; recommended that parents restrict children under 17 from viewing or allow them to view only when supervised by a parent or adult guardian.

4 PG 13 – Material is unsuitable for children under age 13.

3 PG – Parental Guidance suggested.

2 G – General Audience; recommended as acceptable for viewers of all ages.

1 KID SAFE – Kids material; recommended especially for children and viewers of all ages.

– Divx Subtitle

To select font type that supports the recorded Divx subtitle.

Standard - Display a standard list of Roman subtitle fonts provided by this unit.

Central Europe - Display central Europe fonts.

Cyrillic - Display cyrillic fonts.

– Default

If RESET is selected, all the items in the setup menu will be reset to default setting, except Parental Setting and Password.

Tuner Operations

IMPORTANT!

- **Make sure FM and MW antennas are connected.**

Tuning to radio stations

- 1 Press **TUNER** key on the front panel repeatedly until "FM X X" or "MW X X" appears on the display panel (or press **TUNER** key on the remote control)
- 2 Press and hold ◀◀ / ▶▶ on the system or on the remote control until "SEARCH->" appeared, then release.
 - The first radio station with sufficient signal strength will appear on the display.
- 3 To tune a weak station, press ◀◀ / ▶▶ on the system or on the remote control to search until a radio station with sufficient signal strength is found.

Presetting radio stations

You can store up to 40 preset radio stations in the memory, starting from FM and followed by MW bands. There are three different ways to program the radio stations:

- Using auto install (for first time setup only)
- Automatic preset programming
- Manual preset programming

Note:

- If no stereo signal is detected during tuner installation, "NO SIGNAL PLEASE CHECK ANT" will appear on the VFD.

Using auto install

When you plug in the unit for the very first time, you will be prompted to install the radio stations. With this feature, you can install all the available tuner station automatically with one touch of button.

When "AUTO INSTALL PRESS PLAY" appears.

- Press ▶|| on the system,
 - This until starts searching from the FM band followed by the MW band.
 - All the available radio stations with strong signal will be stored automatically.
 - When all the available radio stations are stored or the memory for 40 presets are used, the first preset radio station will be played.

Automatic preset programming

You can start automatic presetting from a selected preset number:

- 1 Press **TUNER** key to select TUNER mode.
 - The current radio frequency will appear on the display.

To begin automatic preset from a desired preset number

- Press ◀ / ▶ or **numeric keys (0-9)** to select the desired preset number:
- 2 Press and hold **PROGRAM** on the remote control until ">>> AUTO " appears on the display.
 - The system will start to search all radio stations on the FM band, then MW band.
 - All radio stations with strong signal strength will be stored automatically.
 - The system will stop searching when all available radio stations are stored or when the memory of 40 preset radio stations is full.
 - If no stereo signal is detected during tuner installation, "NO SIGNAL PLEASE CHECK ANT" will appear on the VFD.

To stop storing the automatic preset

- Press ■ to stop storing the automatic preset.

Manual preset programming

- 1 Press **TUNER** key repeatedly to select the desired tuner band: FM or MW.
 - 2 Press and hold ◀◀ / ▶▶ on the system or on the remote control to search a radio frequency.
 - 3 Press **PROGRAM**.
→ "PROG" and "00 00.00" will display.
 - 4 Press ◀ / ▶ or **numeric keys (0-9)** to select the desired preset number.
 - 5 After selecting an address number, press **PROGRAM** again to store the radio station.
- Repeat **steps 3-5** to store other preset radio stations.

Note:

- If you attempt to store more than 40 preset radio stations, "FULL" will be displayed.
- This until exits presetting mode if no button is pressed with 20 seconds.

Selecting a preset radio station

- In tuner mode, press ◀ / ▶ or use the **numeric keys (0-9)** to select the desired preset number.
→ The preset number and radio frequency appear on the display panel.

Deleting a preset radio station

- 1 In tuner mode, press ◀ or ▶ keys to select the preset radio station to be erased.
 - 2 Press and hold ■ on the system until "DELETE" appears on the display panel.
→ The current preset radio station will be deleted.
→ The rest of the preset radio stations will shift up.
- Repeat **steps 1-2** to erase other preset radio stations.

Changing tuning grid

In some countries (only applicable for certain regions), **this function can change the frequency steps between grid 9 and grid10**, the frequency step between adjacent channels in the MW band is 9 kHz tuner mode, (10 kHz in some areas). The preset frequency step in the factory is 9 kHz.

- 1 Plug the AC power cord.
- 2 Press **TUNER** to select MW mode.
- 3 Press and hold ▶|| button for more than 5 seconds on the panel.

Note:

- All preset stations will be lost and need to be reprogrammed.

Tape Operation/Recording

IMPORTANT!

- Before playing a tape, check and tighten slack tape with a pencil. Slack tape may get jammed or may burst in the mechanism.
- Store tapes at room temperature and do not put them too close to a magnetic field (for example, a transformer, TV set or speaker).

Tape playback

- 1 Press **OPEN/CLOSE** to open the tape deck door:
- 2 Insert a recorded tape and close the tape door:
 - Load the tape with the open side down and the full spool to the left.

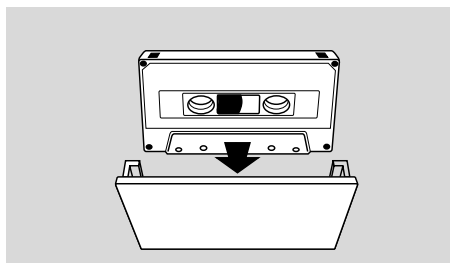

- 3 Press **TAPE/AUX** on the system or on the remote control repeatedly to select tape mode
- 4 Press **▶||** to start playback.

To stop playback

- Press **■**.

Rewinding or forwarding fast when playback is stopped

- 1 Press **◀◀** or **▶▶**
- 2 Press **■** when you reach the desired passage.

General information on recording

- If you don't intend to record via the microphone, unplug it to avoid unwanted recording source.
- For recording, only use tape of IEC type I (normal tape).
- The recording level is set automatically, regardless of the position of the Volume, Vocal, Key control and so forth.
- The type is secured at both ends with leader tape. At the beginning and end of the tape, nothing will be recorded for seven seconds.
- To prevent accidental recording, break out the tab on the left shoulder of the tape side you want to protect.

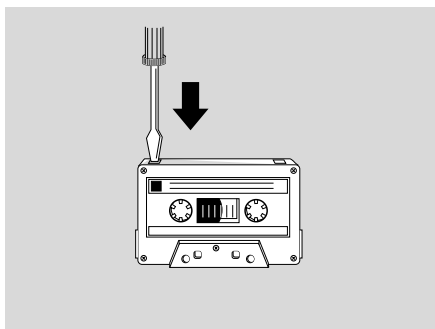

- Press **RECORD** in Disc/USB, Tuner/AUX mode, "NO TAPE" will display on the VFD if there is no recordable tape in tape deck .

IMPORTANT!

- Recording is permissible if copyright or other rights of third parties are not infringed upon.
- Recording is possible only in tape deck

Preparation for recording

- 1 Load a recordable tape into tape deck with the full spool to the left.
- 2 Prepare the source to be recorded.
DISC – load the disc
USB – insert a USB driver
TUNER – tune to the desired radio station.
AUX – connect external equipment.
- 3 Press **DISC, USB, TUNER, AUX** to select the source.
- 4 Start to play the selected source.
- 5 Press **RECORD** to start recording.

To stop recording

- Press **■** on the system.

Disc synchro recording

- 1 Press **DISC** to select the disc mode.
- You can record programmed tracks in the order you want.
- 2 Press **RECORD** to start recording.
→ "REC" will flash, but the first 7 seconds of the start passage will not be recorded.

Selecting another track during recording

- 1 Press **▶II**.
- 2 Press **◀** or **▶** to select another track.
- 3 Press **▶II** to resume recording.

To stop recording

- Press **■**.
→ Recording and disc playback will stop simultaneously.



Be responsible
Respect copyrights

The making of unauthorized copies of copy-protected material, including computer programmes, files, broadcasts and sound recordings, may be an infringement of copyrights and constitute a criminal offence. This equipment should not be used for such purposes.

Listening to an external source

You can listen to the sound of the connected external device through your FWD876.

- 1 Connect the audio out terminals of the external equipment (TV,VCR, Laser Disc player; DVD player or CD Recorder) to the AUX IN terminals of your system.
- 2 Press TAPE/AUX once or twice on the system (or on the remote control) to select AUX
- 3 To avoid noise distortion, turn down the volume on your external device.
- 4 Press the **PLAY** key on the connected device to start playback.
- 5 To adjust the sound and volume , use the sound controls on your external device and the FWD876.

Notes:

- *You are advised not to listen to and record from the same source simultaneously.*
- *All navigation sound control features are available.*

Clock/Timer Operations

Viewing the clock

The clock (if it is set) will be shown in standby mode.

To view the clock in any source mode (DISC or TUNER) for example:

- Press **CLOCK** on the system.
 - The clock is displayed for a few seconds.
 - If the clock has not been set, "NO CLOCK" is displayed for a few seconds.

Setting the clock

- 1 In standby mode, press and hold **CLOCK** on the system,
 - The clock digits flash on the display panel.
 - If the clock has not been set, "--:--:--" flashes
- 2 Press **◀ / ▶** repeatedly to set the hour.
- 3 Press **◀◀ / ▶▶** repeatedly to set the minute.
- 4 Press **DISPLAY/OSD** repeatedly to switch to between 12-hour and 24-hour display.
- 5 Press **CLOCK** again to store the setting.
 - The clock starts working.

Notes:

- The clock setting will be erased when the system is disconnected from the power supply.
- The system will exit clock setting mode if no button is pressed within 10 seconds.
- To exit clock setting without storing, press **STOP** on the system to exit.

Setting the wake-up timer

The system can switch on to DISC, USB, TUNER or TAPE mode automatically at a preset time, serving as an alarm to wake you up.

IMPORTANT!

- Before setting the timer, ensure that the clock is set correctly.
 - To set a new timer, you need to deactivate the previously set timer.
- 1 In standby mode, press and hold **TIMER/SLEEP** on the remote for more than five seconds to enter timer setting mode.
 - The source and timer digits will be light on the display panel.

- 2 Press **DISC, USB, TUNER, TAPE/AUX** to select the desired source.
 - Before setting timer, make sure the music source has been prepared.
 - DISC** – load the disc(s).
 - USB** – insert a USB driver.
 - TUNER** – tune to the desired radio station.
 - TAPE** – Insert a recorded tape.
 - 3 Press **◀ / ▶** repeatedly to set the hour.
 - 4 Press **◀◀ / ▶▶** repeatedly to set the minute.
 - 5 Press **TIMER/SLEEP** to store the time.
- At the preset time, the selected source will be played.

Viewing the timer

- 1 In standby mode, Press **TIMER/SLEEP** to view timer (e.g "DISC 03:30"). Timer will be shown on the display for a few seconds and then go back to it's previous status.
- 2 If timer have not been set, "TIMER OFF" will be displayed for a few seconds.

To deactivate the wake-up timer

- In standby mode, press **TIMER/SLEEP** to the view timer mode, then press **STOP** until "TIMER OFF" is displayed on the panel. (press **STOP** again to switch to "TIMER ON")

Notes:

- The system will exit timer setting mode if no button is pressed within 10 seconds.
- Display shows  if activated, and disappears if deactivated.

Setting the sleep timer

The sleep timer enables the system to switch off by itself after a set period of time.

- 1 Press **TIMER/SLEEP** on the remote control repeatedly to select a preset time.
 - The selections are as follows (time in minutes):
 - 15 → 30 → 45 → 60 → 90 → 120 → OFF
- 2 Press **TIMER/SLEEP** until you reach the desired length of time.

To deactivate the sleep timer

- Press **TIMER/SLEEP** repeatedly until "OFF" is displayed, or press the **STANDBY ON**  button.

Sound control

Selecting sound effect

The digital sound effect allows you to select from various preset modes that control the frequency bands of sound to optimize certain musical styles. It greatly enhances the excitement and enjoyment of your favorite music.

- Press **SOUND** repeatedly to select the available sound effect.
- You can select Digital Sound Control:
 - **TECHNO, ROCK, JAZZ, OPTIMAL**, (in music mode).
 - **CONCERT, ACTION, DRAMA, SCI- FI** (in movie mode)

Selecting surround sound effect

- Press **SURROUND** to select multi-channel surround or stereo.
 - The availability of the various surround sound modes depend on the sound available on the disc.
 - The center and rear speakers operate only in multi-channel surround mode.
 - The available output modes for multi-channel include: DTS surround ,Dolby Digital, Dolby Pro-Logic surround.
 - Stereo broadcasts or recordings will produce some surround channel effects when played in a surround mode.

Selecting DBB effect

- Press **DBB** to set the Dynamic Bass Boost.
- You can select settings to enhance the bass response:
 - **DBB 1, DBB 2, DBB 3, DBB OFF**.

Selecting MAX SOUND effect

- Press **MAX SOUND** on the system or **MAX** button on the remote control to select “**MAX ON**” to achieve optimal sound.
 - When **MAX SOUND** is activated, **MAX** icon will blink and “**MAX ON**” will appear on the display for 3 seconds.
- Press **MAX SOUND** on the system or **MAX** button again to select “**MAX OFF**” to achieve optimal sound.
 - When **MAX SOUND** is deactivated, “**MAX OFF**” will appear on the display for 3 seconds. **MAX** icon will turn off.

Volume control

Changing the volume level

- Press **VOL +/-** (or turn **VOLUME +/-** clockwise or anticlockwise) to increase or decrease the master volume level.
 - “**VOL MIN**” is displayed at minimum level.
 - “**VOL MAX**” is displayed at maximum level.
 - The range is from 0dB to 40dB, and the step is 1 dB.

Switching off the volume temporarily

- Press **MUTE**.
 - “Mute” is displayed on the TV.
 - Press **MUTE** again or adjust the volume level to cancel the MUTE mode.
 - “Mute off” is displayed on the TV.

IMPORTANT!

Compatibility of the USB connection on this MINI HI-FI system

- This MINI HI-FI system supports most USB Mass storage devices (MSD) that are compliant to the USB MSD standards.
 - Most common Mass storage class devices are flash drives, memory sticks, jump drives and etc.
 - If you see a "Disc Drive" show up on your computer after you plugged the mass storage device into your computer, most likely it is MSD compliant and it will work with this MINI HI-FI system.
 - If your Mass storage device required a battery / power source. Please make sure you have a fresh battery in it or charge the USB device first and then plug it into the MINI HI-FI system again.

Supported Music type

- This device only supports unprotected music with the following file extension:
 - .mp3
 - .wma
- Music bought from on-line music stores are not supported because they are secured by Digital Rights Management protection (DRM).
- File name extensions that end with the following are not supported:
 - .wav; .m4a; .m4p; mp4; .aac and etc.

No Direct connection can be made from Computer USB port to the MINI HI-FI system even you have mp3 files in your computer.

Using a USB device

By inserting a USB device to the MINI HI-FI system, you can enjoy the device's stored music or picture through the powerful speakers of MINI HI-FI system.

General information on USB device

Compatible USB device

With the MINI HI-FI system, you can use

- USB flash memory (USB2.0 or USB1.1)
- USB flash players (USB2.0 or USB1.1)
- Memory cards (requires an additional card reader to work with this MINI HI-FI system)

Note:

- In some USB flash player (or memory devices), the stored contents are recorded using copyright protection technology. Such protected contents will be unplayable on any other devices. (Such as this MINI HI-FI system)

USB Operations

USB playback

You can play or view the data files (JPEG , MP3,WMA or DivX). In the USB flash driver or USB memory card reader. However, editing or copying the data file is not possible.

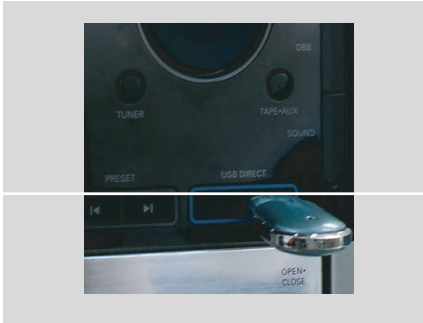

- 1 Connect the USB flash driver / USB memory card reader directly to the **USB DIRECT** socket on this unit.
- 2 Press **USB** on the remote control (or press **USB** key on the system) to access the device is detected.
 - When using multiple drives on a single card reader, only one of the connected cards can be accessed.
 - The device numbers may vary with different card readers.
- 3 Select the file and press **OK** to play .

Helpful Hints:

- When the USB devices does not fit into the **USB DIRECT**, a USB extension cable is required.
- You can only read and playback the content from the USB device.
- Copy-protected contents are not playable.

Dimming the display

- Press **DIM** repeatedly to select different levels of brightness for the display: DIM HIGH, DIM MID or DIM LOW.

Vocal

This function allows you to fade out the original vocal from a karaoke. Press **AUDIO** key repeatedly to select different audio modes.

KARAOKE Setup

In DISC / USB mode, press **KARAOKE** on the remote control to enter Karaoke menu to set up KARAOKE.

Karaoke Setup Page		
MIC	Off	On
Mic Volume	10	Off
Echo Level	10	
Key	00	
Score	Off	

Mic

- This feature allows you to turn microphone on/off .

Mic Volume

- This feature allows you to increase/decrease microphone volume (range from 00~+20).

Echo Level

- This feature allows you to add echo while singing or talking through a microphone.

Key

- This feature allows you to change the key tone when you play in DISC/USB mode.

Score

- There are three levels of Scoring difficulty for Basic, Intermediate, Advance. Select Off to turn off the karaoke scoring.

- 1 Press **▲ / ▼** and **◀◀** or **▶▶** keys on the remote control to navigate in the menu .
- 2 Press **OK** to confirm your selection.

Removing { **Karaoke setup page** }
Press **KARAOKE** again.

Other Functions

Karaoke

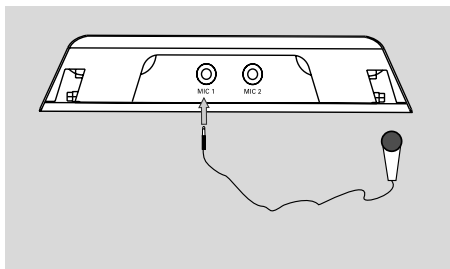

Connect a microphone (not supplied) to the system to sing along with the music source.

- 1 Connect a microphone to the **MIC 1** or **MIC 2** jack.
→ "Mic on" will appear on the TV .
- Before connecting the microphone, set the **MiC Volume** to the minimum level to prevent howling.
- 2 Press **DISC, (or USB,TAPE/AUX)** to select the source to be mixed and start playback.
- 3 Adjust the volume of the source through **VOLUME +/-** control.
- 4 Adjust the microphone volume through **MiC Volume** control , please refer to **Page 41 (KARAOKE setup)** .

Notes:

- *Keep the microphone away from the speakers to prevent howling.*

AMPLIFIER SECTION

Total output power	8000W PMPO
5.1Dolby Digital surround mode.....600W RMS(5x80W/ch+200W/ch)
Main set	2x80W RMS
Frequency Response ...	150 Hz - 18kHz / \pm 3 dB
Signal-to-Noise Ratio	> 65dB (A-weighted)
Input Sensitivity	
AUX In	2V
Output Sensitivity	
Line Out.....(CD mode) 2V	

TUNER SECTION

Tuning RangeFM 87.5 – 108 MHz (50 kHz steps)
.....MW 531 – 1602 kHz (9 kHz steps)
.....MW 530 – 1700 kHz (10 kHz steps)
Signal-to-Noise Ratio	FM \geq 50 dB
.....MW \geq 40 dB

TAPE SECTION

Frequency Response	
Normal tape	125~8000 Hz(\pm 4 dB)
Signal-to-Noise Ratio	
Normal tape (type 1)	\geq 45 dBA
Wow and flutter	\leq 0.35%

DVD SECTION

Laser Type	Semiconductor
Disc Diameter.....	12cm / 8cm
Video Decoding	MPEG-2 / MPEG-1
Video DAC	12 Bits
Signal System	PAL / NTSC
Video Format	4:3 / 16:9
Video S/N	56 dB (minimum)
Composite Video Output	1.0Vp-p, 75 Ω
S-Video Output	Y - 0.714Vp-p, 75 Ω
.....	C - 0.286 Vp-p, 75 Ω
Audio DAC	24 Bits / 96 kHz
Frequency Response ...	4 Hz - 20 kHz (44.1kHz)
.....	4 Hz - 22 kHz (48kHz)
.....	4 Hz - 44 kHz (96kHz)

MAIN UNIT

Power Supply Rating 110 -127V / 220 - 240V~50/60HZ
Power Consumption	
Active	100 W
ECO	<1W
Dimensions (w x h x d)190.6x 411.8x 315.2(mm)
Weight	5.2 kg
Packaging Dimensions (w x h x d) 663 x 627 x 565 (mm)
Gross weight	35.7Kg

SPEAKERS

Front speakers	
System	3-way, Bass reflex
Impedance	4 Ω
Speaker drivers	5.25" woofer on body
.....	2" tweeter on body
.....	3" middle range on tunable spk
Frequency response	50 Hz – 20 kHz
Dimensions (w x h x d) 165.2 x 554x 283.2 (mm)
Weight.....	6.5kg x2

Center or Surround speakers

System.....	2 multi directional driver
Impedance.....	4 Ω (center)/4 Ω (surround)
Speaker drivers.....	1x10cm full range (surround)
.....	2x8cm full range (center)
Frequency response.....	150HZ--18KHZ
Dimensions(w x h x d).....165.2x138.6x161.9mm (surround speaker)
.....190.2x109.7x144.9mm (center speaker)
Weight.....	1.425kg (center speaker)
.....1.0x2kg/each (surround speaker)

SUBWOOFER

Power supply rating	110 -127V / 220 - 240V
.....	50-60HZ
Power Consumption.....	130W
Impedance.....	6 Ω
Speaker drivers.....	1x20cm woofer
Frequency response.....	30 -200HZ
Dimensions(w x h x d).....	230x551.5x317.5(mm)
Weight.....	10.77kg

Specifications and external appearance are subject to change without notice.

Troubleshooting

WARNING

Under no circumstances should you try to repair the system yourself, as this will invalidate the warranty. Do not open the system as there is a risk of electric shock.

If a fault occurs, first check the points listed below before taking the system for repair. If you are unable to remedy a problem by following these hints, consult your dealer or Philips for help.

Problem	Solution
No power.	<ul style="list-style-type: none">✓ Check if the AC power cord is properly connected.
"NO DISC" is displayed.	<ul style="list-style-type: none">✓ Check if the disc is inserted upside down.✓ Wait until the moisture condensed at the lens has cleared.✓ Replace or clean the disc, see "Maintenance".✓ Use a readable disc or correctly recorded format MP3-CD.
No picture.	<ul style="list-style-type: none">✓ Select the appropriate video input mode on the TV set.✓ Check if the TV set is switched on.✓ Check the video connection.✓ Check if the system is securely connected.
Distorted or poor picture.	<ul style="list-style-type: none">✓ Sometimes a slight picture distortion may appear. This is not a malfunction.✓ Clean the disc.✓ Connect the system to the S-video input of your TV set.
The aspect ratio of the screen cannot be changed even though you have set the TV shape.	<ul style="list-style-type: none">✓ The aspect ratio is fixed on the DVD disc.✓ The aspect ratio may not be changed for some TV systems.
The DVD player does not start playback.	<ul style="list-style-type: none">✓ Insert a readable disc.✓ Check the disc type, color system and region code.✓ Clean the disc.✓ Place the disc with the playback side down.✓ Press SYSTEM MENU to turn off the setup menu.✓ Cancel the parental control rating function or change the rating level.✓ Moisture has condensed inside the system. Remove the disc and leave the system turned on for about an hour.
The system does not respond when the buttons are pressed.	<ul style="list-style-type: none">✓ Disconnect the power plug from the jack, and insert again.

Problem	Solution
The language for the sound or subtitle cannot be changed when playing a DVD.	<ul style="list-style-type: none"> ✓ Multi-language sound or subtitle is not recorded on the DVD. ✓ Changing the language for the sound or subtitle is prohibited on the DVD.
No image is output when a function is selected.	<ul style="list-style-type: none"> ✓ Make sure the component is connected correctly. ✓ Press the correct function button for the input source.
Sound cannot be heard or is of poor quality	<ul style="list-style-type: none"> ✓ Adjust the volume. ✓ Check that the speakers are connected correctly. ✓ Check if the stripped speaker wire is clamped. ✓ Check if the Key value of KARAOKE setup is 0. ✓ If the system is in pause, slow motion or fast forward/reverse mode, press ▶ to resume the normal play mode. ✓ Make sure the MP3-CD was recorded within 32-256 kbps bit rate with sampling frequencies at 48 kHz, 44.1 kHz or 32 kHz.
Poor radio reception.	<ul style="list-style-type: none"> ✓ If the signal is too weak, adjust the antenna or connect an external antenna for better reception. ✓ Increase the distance between the System and your TV set or VCR.
Recording or playback cannot be made	<ul style="list-style-type: none"> ✓ Clean deck parts, see "Maintenance". ✓ Use only NORMAL tape. ✓ Apply a piece of adhesive tape over the missing tab space.
The tape deck door cannot open	<ul style="list-style-type: none"> ✓ Remove and reconnect the AC power plug and switch on the system again.
Left and right sound outputs are reversed.	<ul style="list-style-type: none"> ✓ Check the speaker connections and location.
The remote control does not function.	<ul style="list-style-type: none"> ✓ Point the remote control at the remote control sensor of the unit. ✓ Reduce the distance to the player: ✓ Remove any possible obstacles. ✓ Replace the batteries with new ones. ✓ Check that the batteries are loaded correctly.
The display is dark	<ul style="list-style-type: none"> ✓ Press DIM on the remote control again.
The timer is not working	<ul style="list-style-type: none"> ✓ Set the clock correctly. ✓ If recording is in progress, stop it
The Clock/Timer setting is erased	<ul style="list-style-type: none"> ✓ Power has been interrupted or the power cord has been disconnected. Reset the clock/timer.

Analog: Sound that has not been turned into numbers. Analog sound varies, while digital sound has specific numerical values. These jacks send audio through two channels, the left and right.

Aspect ratio: The ratio of vertical and horizontal sizes of a displayed image. The horizontal vs. vertical ratio of conventional TVs is 4:3, and that of wide-screens is 16:9.

AUDIO OUT Jacks: Jacks on the back of the DVD System that send audio to another system (TV set, Stereo, etc.).

Bit Rate: The amount of data used to hold a given length of music; measured in kilobits per second, or kbps. Or, the speed at which you record. Generally, the higher the bit rate better the sound quality. However, higher bit rates use more space on a Disc.

Chapter: Sections of a picture or a music piece on a DVD that are smaller than titles. A title is composed of several chapters. Each chapter is assigned a chapter number enabling you to locate the chapter you want.

Component Video Out Jacks: Jacks on the back of the DVD System that sends high-quality video to a TV set that has Component Video In jacks (R/G/B, Y/Pb/Pr, etc.).

Disc menu: A screen display prepared for the selection of images, sound, subtitles, multi-angles, etc recorded on a DVD.

Digital: Sound that has been converted into numerical values. Digital sound is available when you use the DIGITAL AUDIO OUT COAXIAL or OPTICAL jacks. These jacks send audio through multiple channels, instead of just two channels as analog does.

Dolby Digital: A surround sound system developed by Dolby Laboratories containing up to six channels of digital audio (front left and right, surround left and right and center).

DTS: Digital Theater Systems. This is a surround sound system, but different from Dolby Digital. The formats were developed by different companies.

JPEG: A still-picture data compression system proposed by the Joint Photographic Expert Group, which features small decrease in image quality in spite of its high compression ratio.

MP3: A file format with a sound data compression system, "MPE" is the abbreviation of Motion Picture Experts Group 1 (or MPEG-1) Audio Layer 3. Through the MP3 format, one CD-R or CD-RW can contain about 10 times as much data volume as a regular CD can.

Multichannel: DVD is specified to have all sound tracks constitute one sound field. Multichannel refers to a structure of sound tracks having three or more channels.

Parental control: A function of the DVD to limit playback of the disc by the age of the users according to the limitation level in each country. The limitation varies from disc to disc; when it is activated, playback will be prohibited if the software's level is higher than the user-set level.

PCM (Pulse Code Modulation): A system for converting analog sound signal to digital signal for later processing without data compression.

Playback control (PBC): Refers to the signal recorded on video CDs or SVCDs for reproduction control. By using screen menus recorded on a Video CD or SVCD that supports PBC, you can enjoy interactive-type software as well as software having a search function.

Progressive Scan (P-Scan): It displays all the horizontal lines of a picture at one time, as a signal frame. This system can convert interlaced video from DVD into progressive format for connection to a progressive display. It dramatically increases the vertical resolution. A progressive scan TV set is needed to receive progressive scan output from the system.

Region code: A system allowing discs to be played only in preset regions. This unit will only play discs that have compatible region codes. You can find the region code of your unit from the product label. Some discs are compatible with more than one region (or ALL regions).

S-Video: Produces a clear picture by sending separate signals for luminance and the color. You can use S-Video only if your TV set has S-Video In jack.

Sampling Frequency: Frequency of data sampling when analog data is converted to digital data. Sampling frequency numerically represents how many times the original analog signal is sampled per second.

Surround: A system for users to create realistic three-dimensional sound fields full of realism by arranging multiple speakers around the listener.

Title: The longest section of a picture or music feature on DVD, music, etc., in video software, or the entire album in audio software. Each title is assigned a title number enabling you to locate the title you want.

VIDEO OUT jack: Jack on the back of the DVD System that sends video to TV.

Meet Philips at the Internet
<http://www.philips.com>

English

中文

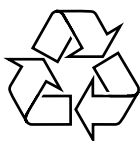

FWD876



Printed in China

PDCC-JS-ZC-0801