

**FX901**

PNP Epitaxial Planar Silicon Transistor
 N-Channel MOS Silicon FET
 Silicon Schottky Barrier Diode
DC-DC Converter Applications

Features

- Composite type with a PNP transistor and a 2.5V drive N-channel MOSFET with a built-in low forward-voltage Schottky barrier diode facilitating high-density mounting.

Electrical Connection

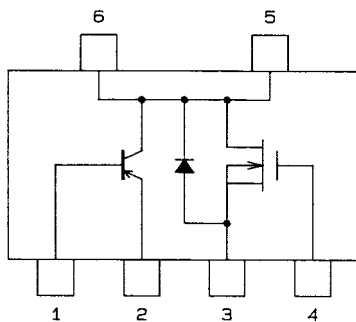

Package Dimensions

unit:mm

2133

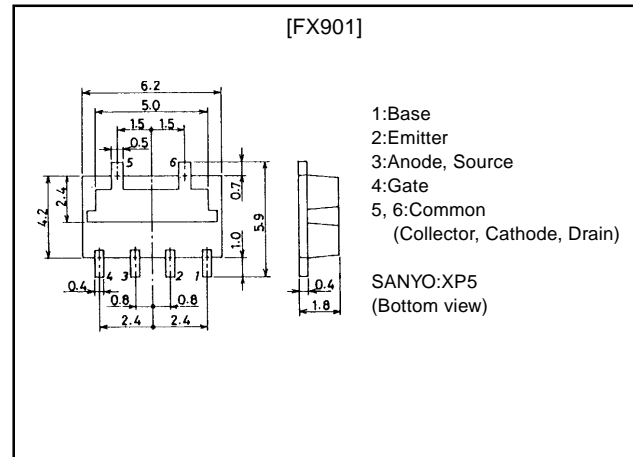

Specifications

Absolute Maximum Ratings at Ta = 25°C

Parameter	Symbol	Conditions	Ratings	Unit
Allowable Power Dissipation	P	Tc=25°C, 1 unit	8	W
	P	Mounted on ceramic board (750mm ² ×0.8mm) 1 unit	1.5	W
Total Power Dissipation	P _T	Mounted on ceramic board (750mm ² ×0.8mm)	2	W
Storage Temperature	T _{stg}		-55 to +150	°C
[TR]				
Collector-to-Base Voltage	V _{CBO}		-15	V
Collector-to-Emitter Voltage	V _{CEO}		-11	V
Emitter-to-Base Voltage	V _{EBO}		-7	V
Collector Current	I _C		-3	A
Collector Current (Pulse)	I _{CP}		-5	A
Base Current	I _B		-600	mA
Junction Temperature	T _J		150	°C
[MOSFET]				
Drain-to-Source Voltage	V _{DSS}		11	V
Gate-to-Source Voltage	V _{GSS}		±10	V
Drain Current (DC)	I _D		2	A
Drain Current (Pulse)	I _{DP}	PW≤10μs, duty cycle≤1%	8	A
Channel Temperature	T _{ch}		150	°C
[SBD]				
Average Rectified Current	I _O		500	mA

· Marking:901

Continued on next page.

SANYO Electric Co.,Ltd. Semiconductor Business Headquarters

TOKYO OFFICE Tokyo Bldg., 1-10, 1 Chome, Ueno, Taito-ku, TOKYO, 110-8534 JAPAN

52098HA (KT)/32996YK (KOTO) TA-0622 No.5387-1/5

FX901

Continued from preceding page.

Electrical Characteristics at Ta = 25°C

Parameter	Symbol	Conditions	Ratings			Unit
			min	typ	max	
[TR]						
Collector Cutoff Current	I_{CBO}	$V_{CB}=-12V, I_E=0$			-0.1	μA
Emitter Cutoff Current	I_{EBO}	$V_{EB}=-6V, I_C=0$			-0.1	μA
DC Current Gain	$h_{FE}(1)$	$V_{CE}=-2V, I_C=-0.5A$	140		560	
	$h_{FE}(2)$	$V_{CE}=-2V, I_C=-3A$	70			
Gain-Bandwidth Product	f_T	$V_{CE}=-2V, I_C=-0.3A$		400		MHz
Output Capacitance	C_{ob}	$V_{CB}=-10V, f=1MHz$		26		pF
C-E Saturation Voltage	$V_{CE(sat)}$	$I_C=-1.5A, I_B=-30mA$		-0.22	-0.4	V
B-E Saturation Voltage	$V_{BE(sat)}$	$I_C=-1.5A, I_B=-30mA$		-0.9	-1.2	V
C-B Breakdown Voltage	$V_{(BR)CBO}$	$I_C=-10\mu A, I_E=0$	-15			V
C-E Breakdown Voltage	$V_{(BR)CEO}$	$I_C=-1mA, R_{BE}=\infty$	-11			V
E-B Breakdown Voltage	$V_{(BR)EBO}$	$I_E=-10\mu A, I_C=0$	-7			V
Turn-ON time	t_{on}	See specified Test Circuit		25		ns
Storage Time	t_{stg}	See specified Test Circuit		200		ns
Fall Time	t_f	See specified Test Circuit		10		ns
[MOSFET]						
D-S Breakdown Voltage	$V_{(BR)DSS}$	$I_D=1mA, V_{GS}=0$	11			V
Zero-Gate Voltage Drain Current	I_{DSS}	$V_{DS}=10.4V, V_{GS}=0$			400	μA
Gate-to-Source Leakage Current	I_{GSS}	$V_{GS}=\pm 8V, V_{DS}=0$			± 10	μA
Cutoff Voltage	$V_{GS(off)}$	$V_{DS}=10V, I_D=1mA$	0.5		1.5	V
Forward Transfer Admittance	$ Y_{fs} $	$V_{DS}=10V, I_D=1A$	1.8	2.8		S
Static Drain-to-Source ON-Resistance	$R_{DS(on)}$	$I_D=1A, V_{GS}=4V$		140	200	m Ω
	$R_{DS(on)}$	$I_D=500mA, V_{GS}=2.5V$		200	320	m Ω
Input Capacitance	C_{iss}	$V_{DS}=10V, f=1MHz$		185		pF
Output Capacitance	C_{oss}	$V_{DS}=10V, f=1MHz$		210		pF
Reverse Transfer Capacitance	C_{rss}	$V_{DS}=10V, f=1MHz$		40		pF
Turn-ON Delay Time	$t_{d(on)}$	See specified Test Circuit		15		ns
Rise Time	t_r	See specified Test Circuit		40		ns
Turn-OFF Delay Time	$t_{d(off)}$	See specified Test Circuit		50		ns
Fall Time	t_f	See specified Test Circuit		35		ns
[SBD]						
Forward Voltage	V_F	$I_F=500mA$		0.4	0.45	V
Reverse Recovery Time	t_{rr}	$I_F=500mA, di/dt=50A/\mu s$		20	30	ns

Switching Time Test Circuit [TR]

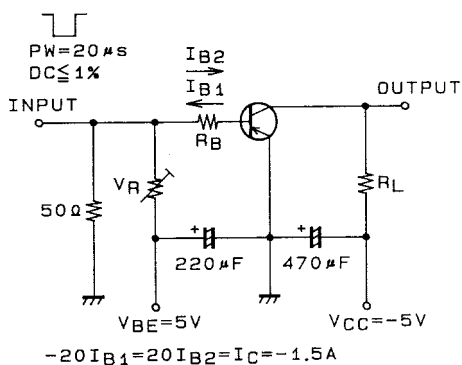

Trr Test Circuit [MOSFET]

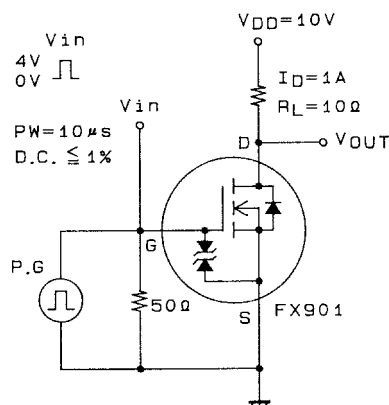

FX901

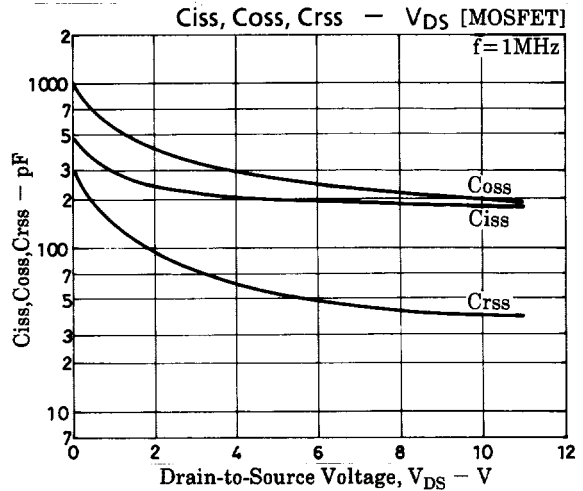
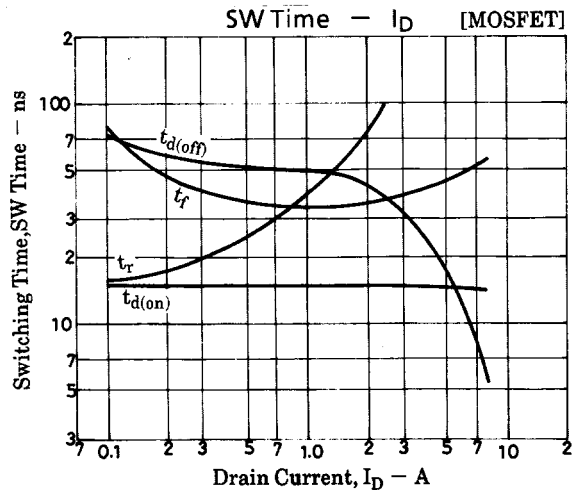
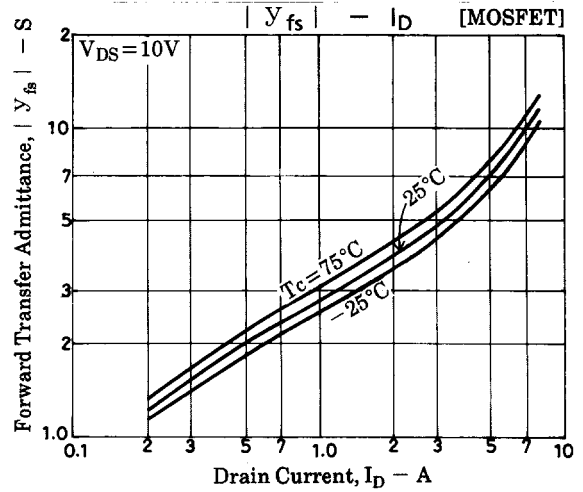
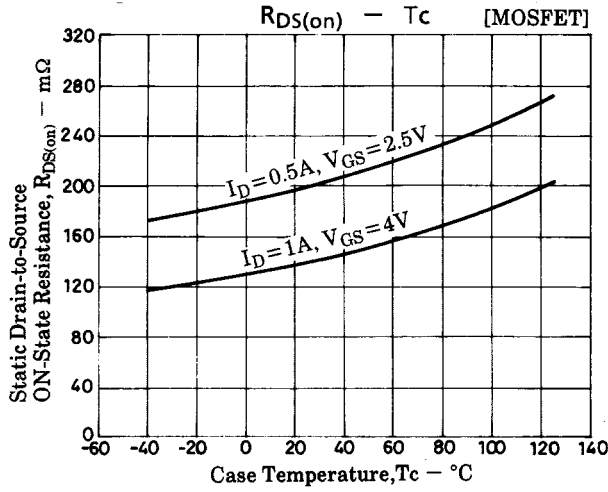
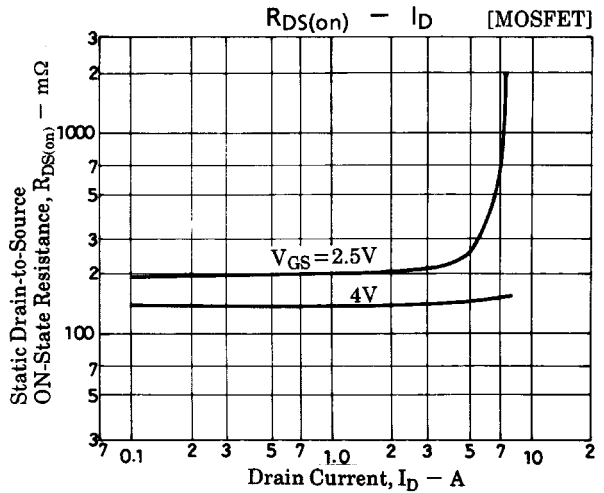
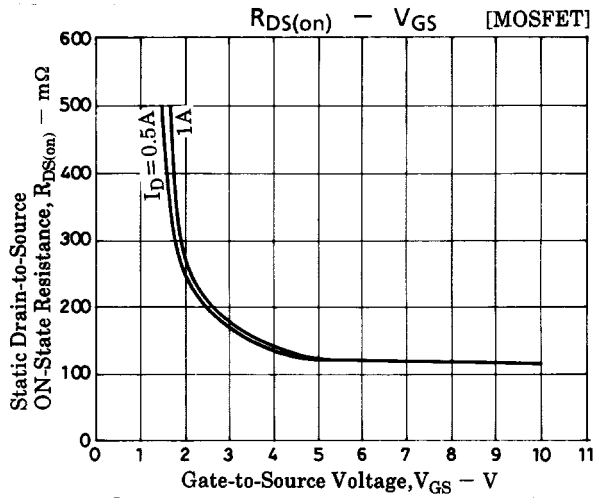
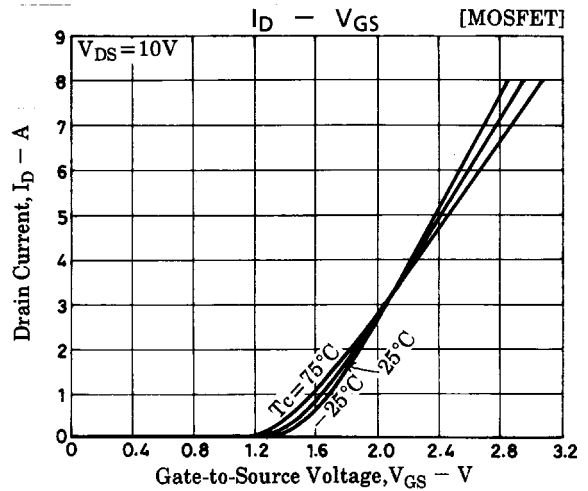
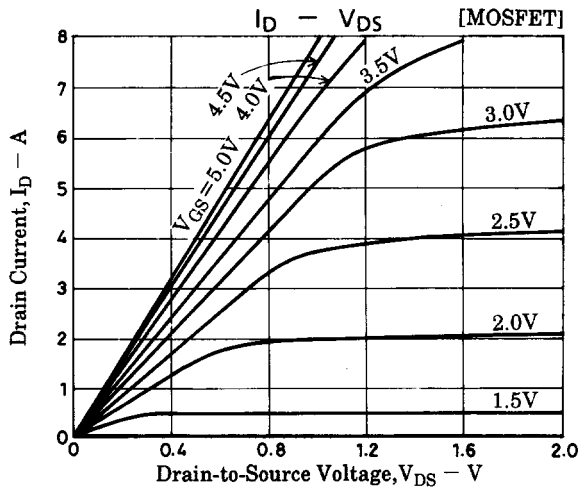

FX901

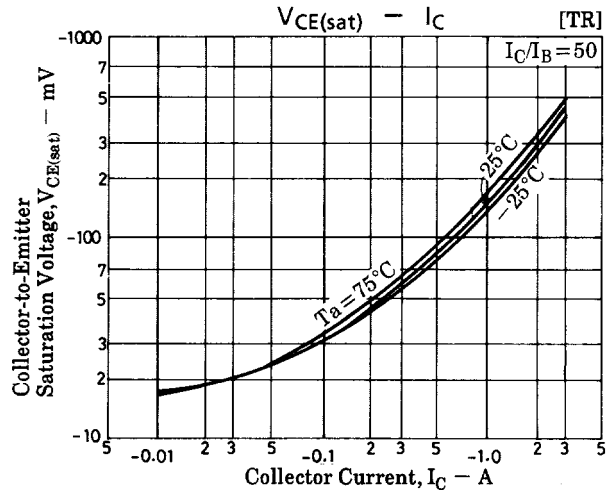
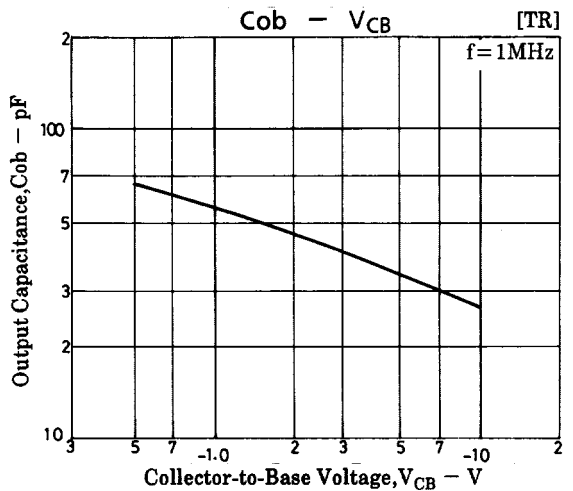
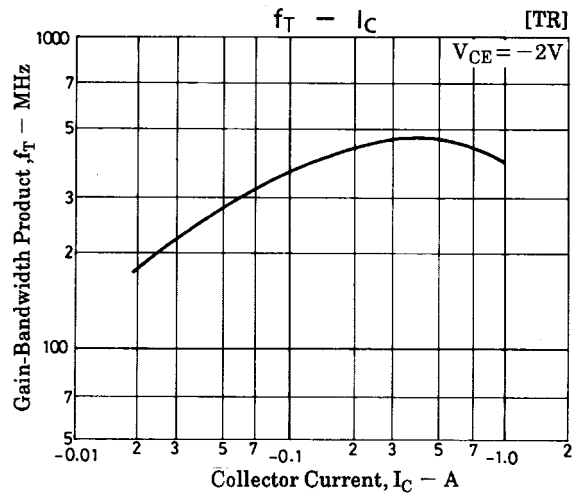
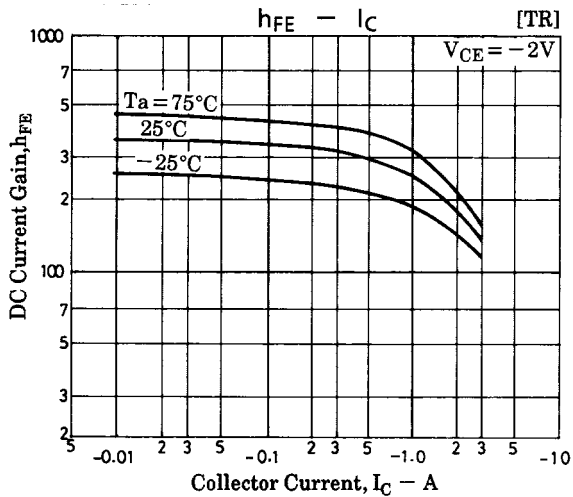
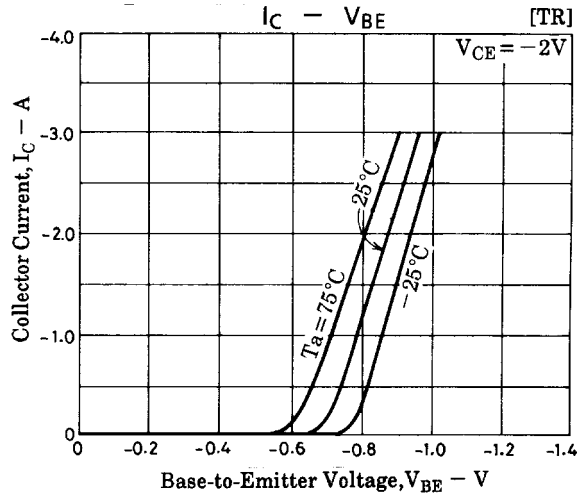
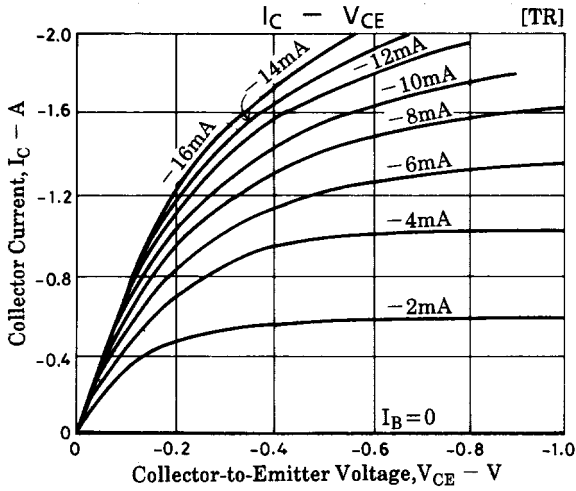
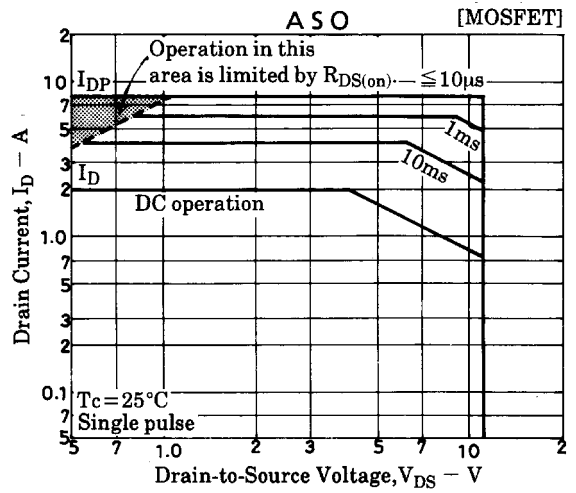
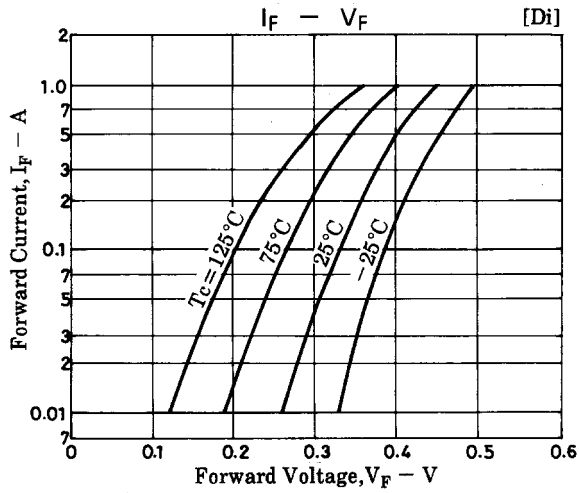

FX901

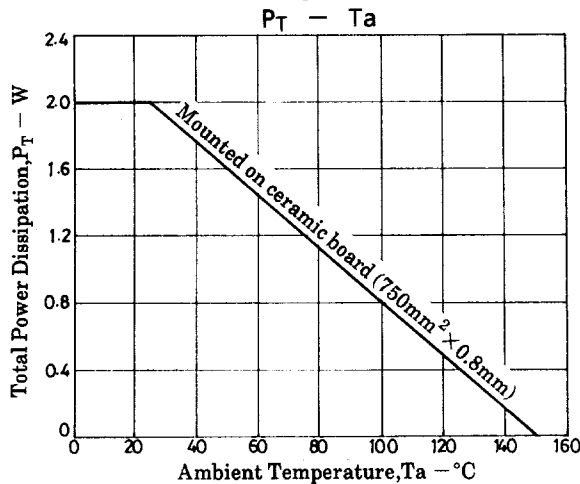
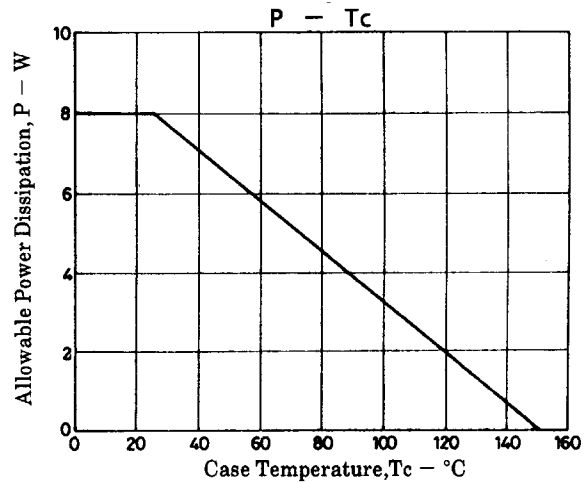
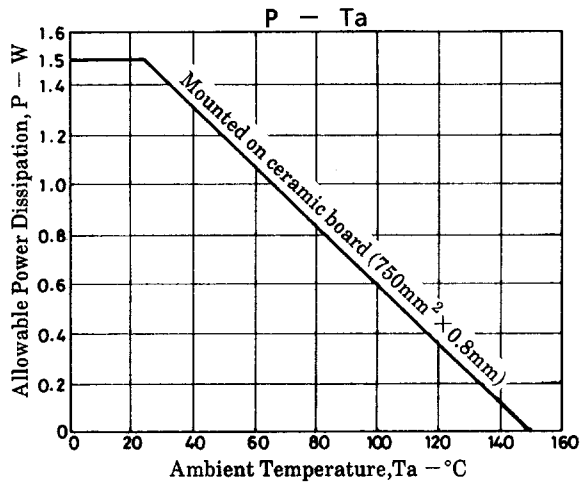
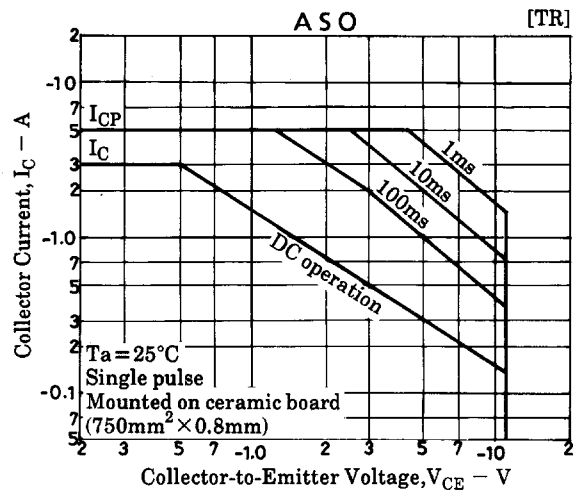
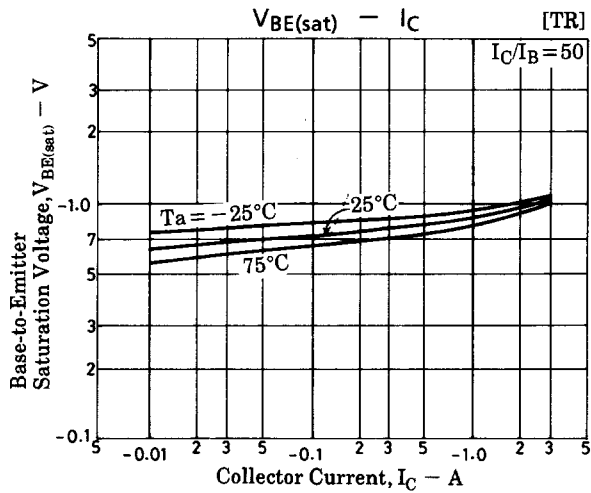

- No products described or contained herein are intended for use in surgical implants, life-support systems, aerospace equipment, nuclear power control systems, vehicles, disaster/crime-prevention equipment and the like, the failure of which may directly or indirectly cause injury, death or property loss.
- Anyone purchasing any products described or contained herein for an above-mentioned use shall:
 - ① Accept full responsibility and indemnify and defend SANYO ELECTRIC CO., LTD., its affiliates, subsidiaries and distributors and all their officers and employees, jointly and severally, against any and all claims and litigation and all damages, cost and expenses associated with such use:
 - ② Not impose any responsibility for any fault or negligence which may be cited in any such claim or litigation on SANYO ELECTRIC CO., LTD., its affiliates, subsidiaries and distributors or any of their officers and employees jointly or severally.
- Information (including circuit diagrams and circuit parameters) herein is for example only; it is not guaranteed for volume production. SANYO believes information herein is accurate and reliable, but no guarantees are made or implied regarding its use or any infringements of intellectual property rights or other rights of third parties.

This catalog provides information as of May, 1998. Specifications and information herein are subject to change without notice.