

PRODUCT SPECIFICATION

Model No.: FYL-48D2LURC1A

Descriptions:
■ Dice material: AlGaInP.
■ Emitting Color: Super bright Red.
■ Device Outline: Φ4.8mm straw hat type.
■ Lens Type: Water clear.



CUSTOMER APPROVED SIGNATURES	APPROVED BY	CHECKED BY	PREPARED BY

NINGBO FORYARD OPTOELECTRONICS CO.,LTD.

Add:NO.115 Qixin Road Ningbo Zhejiang China

Zip:315051

Tel: 0086-574-87933652 87927870 87922206

Fax: 0086-574-87927917

E-mail: Sales@foryard.com (General)

[Http://www.foryard.com](http://www.foryard.com)

■ Absolute maximum ratings(Ta=25 ° c)

Parameter	MAX.	Unit
Power Dissipation	75	mW
Peak Forward Current (1/10 Duty Cycle, 0.1ms Pulse Width)	100	mA
Continuous Forward Current	30	mA
Derating Linear From 50°C	0.4	mA/°C
Reverse Voltage	5	V
Operating Temperature Range	-40°C to +85°C	
Storage Temperature Range	-40°C to +100°C	
Lead Soldering Temperature[4mm(.157") From Body]	260°C for 5 Seconds	

■ Electrical and optical characteristics(Ta=25 ° c)

Parameter	Symbol	Min.	Typ.	Max.	Unit	Test Condition
Luminous Intensity	I _v	-	700	-	mcd	I _F =20mA
Viewing Angle	2θ _{1/2}	-	150	-	Deg	
Peak Emission Wavelength	λ _p	-	630	-	nm	
Dominant Wavelength	λ _d	620	625	630	nm	
Spectral Line Half-Width	Δλ	-	15	-	nm	
Forward Voltage	V _F	1.7	2.0	2.5	V	
Reverse Current	I _R			10	μA	V _R =5V

■ **Typical Electrical Characteristics Curves**
(25 °c Ambient Temperature Unless Otherwise Noted)

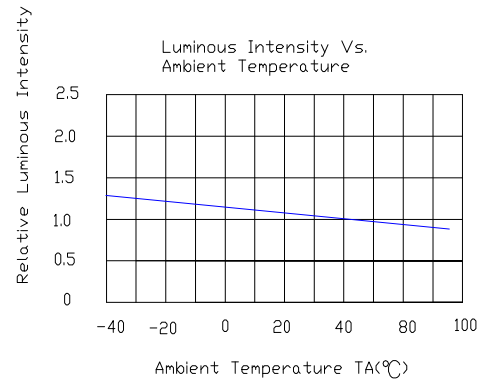
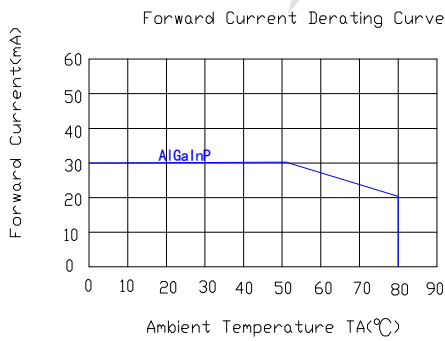
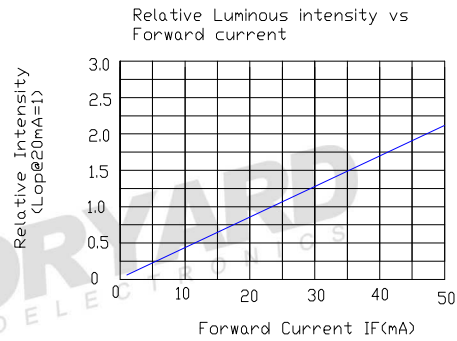
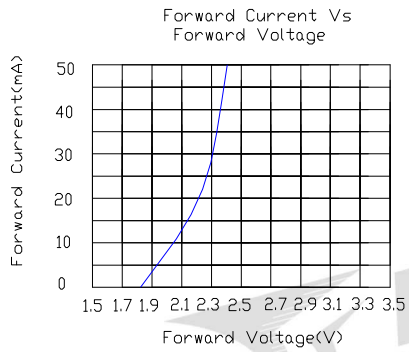
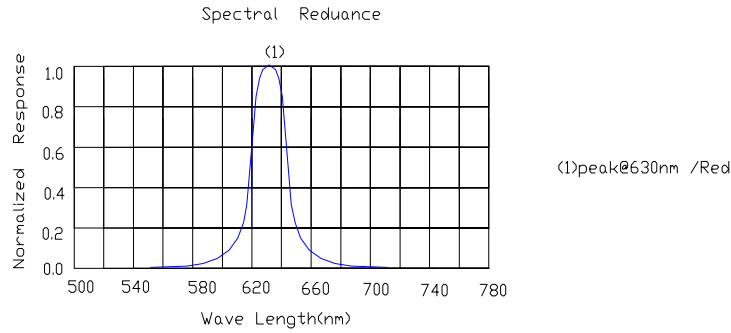

Radiation pattern.

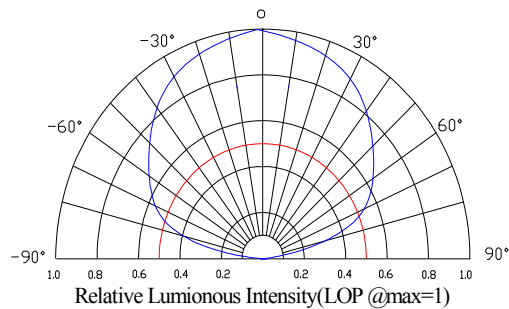

Model. No.	FYL-48D2LURC1A
Rev.	A

■ LAMP PACKING.

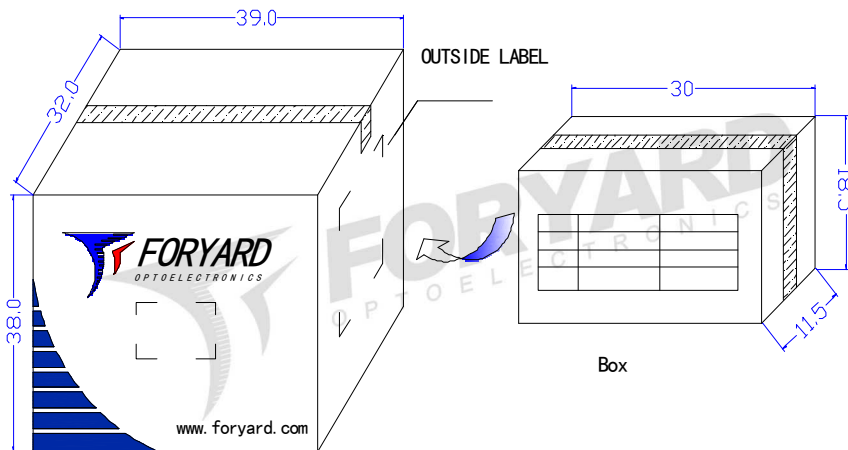
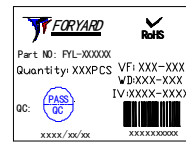
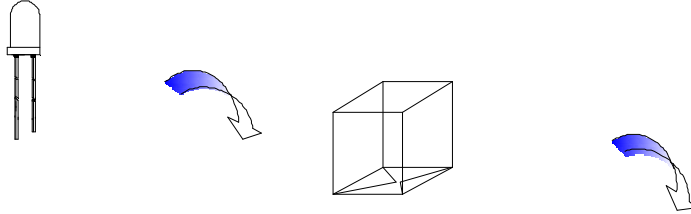

6Boxes/Carton



OUTSIDE LABEL