

AU OPTRONICS CORPORATION

Product Specification

15.0" XGA Color TFT-LCD Module

Model Name: G150XG03 V.1

Approved by	Prepared by
Peter ML Lee	Daniel Chi

GDBD Marketing Division / AU Optronics corporation

Customer	Checked & Approved by

Document Version: 0.0

Total Pages: 30

Date: 7/05/2006

Product Specification

15.0" XGA Color TFT-LCD Module Model Name: G150XG03 V.1

() Preliminary Specifications
(☒) Final Specifications

Note: This Specification is subject to change without notice.

Contents

1.0 Handling Precautions	5
2.0 General Description	6
2.1 Display Characteristics	6
2.2 Optical Characteristics	7
3.0 Functional Block Diagram.....	11
4.0 Absolute Maximum Ratings	12
4.1 TFT LCD Module	12
4.2 Backlight Unit	12
4.3 Absolute Ratings of Environment	12
5.0 Electrical characteristics.....	13
5.1 TFT LCD Module	13
5.2 Parameter Guideline for CCFL Inverter	15
6.0 Signal Characteristic	16
6.1 Pixel Format Image.....	16
6.2 Input Data Format	17
6.3 Signal Description	18
6.4 Interface Timing	19
6.5 Power ON/OFF Sequence	21
7.0 Connector & Pin Assignment	22
7.1 TFT LCD Module	22
7.2 Backlight Unit	24
7.3 Signal for Lamp Connector	24
8.0 Reliability	25
9.0 Shipping and Packing.....	26
9-1 Shipping Label Format.....	26
9-2 Carton Package	26
10.0 Safety	27
10.1 Sharp Edge Requirements	27
10.2 Materials	27
10.3 Capacitors	27
11.0 Other Requirement	27
11.1 National Test Lab Requirement	27
12.0 Mechanical Characteristics.....	28

Record of Revision

Version and Date	Page	Old description	New Description	Remark
0.0 2006/06/30	All	First Edition		
0.1 2006/07/04	28, 29, 30	Old plot	New plot	

1.0 Handling Precautions

- 1) Since front polarizer is easily damaged, pay attention not to scratch it.
- 2) Be sure to turn off power supply when inserting or disconnecting from input connector.
- 3) Wipe off water drop immediately. Long contact with water may cause discoloration or spots.
- 4) When the panel surface is soiled, wipe it with absorbent cotton or other soft cloth.
- 5) Since the panel is made of glass, it may break or crack if dropped or bumped on hard surface.
- 6) Since CMOS LSI is used in this module, take care of static electricity and insure human earth when handling.
- 7) Do not open nor modify the Module Assembly.
- 8) Do not press or pat the panel surface by fingers, hand or tooling.
- 9) Do not press the reflector sheet at the back of the module to any directions.
- 10) In case if a module has to be put back into the packing container slot after once it was taken out from the container, do not press the center of the CCFL reflector edge. Instead, press at the far ends of the CCFL reflector edge softly. Otherwise the TFT module may be damaged.
- 11) At the insertion or removal of the Signal Interface Connector, be sure not to rotate nor tilt the Interface Connector of the TFT module.
- 12) After installation of the TFT module into an enclosure (Desktop monitor Bezel, for example), do not twist nor bend the TFT Module even momentary. At designing the enclosure, it should be taken into consideration that no bending/twisting forces are applied to the TFT module from outside. Otherwise the TFT module may be damaged.

2.0 General Description

This specification applies to the 15.0 inch Color TFT/LCD Module G150XG03 V1.

This module is designed for industrial applications.

The display supports the XGA (1024 (H) x 768(V)) screen format and 16.2M colors (RGB 6-bits + FRC data)/262K (RGB 6-bit) selectable.

All input signals are 1 Channel LVDS interface compatible.

This module does not contain an inverter card for backlight.

All the design rules of this module can correspond to PSWG standard.

2.1 Display Characteristics

The following items are characteristics summary on the table under 25 °C condition:

ITEMS	Unit	SPECIFICATIONS			
Screen Diagonal	[mm]	381 (15")			
Active Area	[mm]	304.128 (H) x 228.096			
Pixels H x V		1024(x3) x 768			
Pixel Pitch	[mm]	0.297 (per one triad) x 0.297			
Pixel Arrangement		R.G.B. Vertical Stripe			
Display Mode		TN mode, Normally White			
White Luminance	[cd/m ²]	250 (Typ) @ 6.0mA			
Contrast Ratio		500			
Response Time	[msec]	12 (Typ)			(Note 1)
Color Saturation		65% NTSC (Typ)			
Nominal Input Voltage VDD	[Volt]	+3.3 V			
Power Consumption (VDD line + CCFL line)	[Watt]	10.7 W (Typ.) @6.0mA (Gray Bar Pattern)			
Weight	[Grams]	1150 (Typ)			
Physical Size	[mm]		Min.	Typ.	Max.
		Horizatal(H)	326.0	326.5	327.0
		Vertical(V)	253.0	253.5	254.0
		Depth(D)	-	-	12.0
Electrical Interface		1 Channel LVDS			
Support Color		16.2M colors (RGB 6-bit + FRC data)/262k(RGB 6-bit) selectable			
Temperature Range	Operating	[°C]	0 to +50		
	Storage (Shipping)	[°C]	-20 to +60		
Surface Treatment		Hard-coating (3H), anti-glare treatment			
ROHS		RoHS Compliance			

Note 1 :System should warm up for at least one hour

2.2 Optical Characteristics

The optical characteristics are measured under stable conditions at 25°C (Room Temperature):

Item	Unit	Conditions	Min.	Typ.	Max.	Note
Viewing Angle	[degree]	Horizontal (Right) CR = 10 (Left)	60 60	70 70	-	-
		Vertical (Up) CR = 10 (Down)	55 45	65 55	-	
		Horizontal (Right) CR = 5 (Left)	65 65	75 75	-	
		Vertical (Up) CR = 5 (Down)	65 65	75 75	-	
Contrast ratio		Normal Direction	400	500	-	-
Response Time	[msec]	Rising Time	-	8.5	11	Note 1
		Falling Time	-	3.5	5	
		Rising + Falling	-	12	-	
Color / Chromaticity Coordinates (CIE)		Red x	0.612	0.642	0.672	
		Red y	0.307	0.337	0.367	
		Green x	0.276	0.306	0.336	
		Green y	0.551	0.581	0.611	
		Blue x	0.114	0.144	0.174	
		Blue y	0.071	0.101	0.131	
Color Coordinates (CIE) White		White x	0.283	0.313	0.343	
		White y	0.299	0.329	0.359	
White Luminance @ IRCFL 6mA (center)	[cd/m ²]		200	250		-
Luminance Uniformity	[%]		75	80		Note 2
Crosstalk (in 75Hz)	[%]			1.2	1.5	Note 3
Flicker	dB				-20	Note 4

Equipment: Pattern Generator, Power Supply, Digital Voltmeter, Luminance meter (PR 880, BM-5A , BM 7 ,CS-1000, CA210, SR_3 & EZ Contrast(ELDIM)*)

Aperture 1° with 50cm viewing distance

Test Point Center (VESA point 9)

Environment < 1 lux

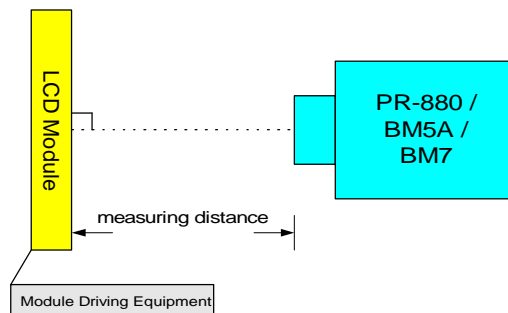

* EZ Contrast is a different measurement tool with very close viewing distance.

Note 1: Definition of Response time

The output signals of photo detector are measured when the input signals are changed from “Full Black” to “Full White” (rising time), and from “Full White” to “Full Black” (falling time), respectively. The response time is interval between the 10% and 90% of amplitudes.

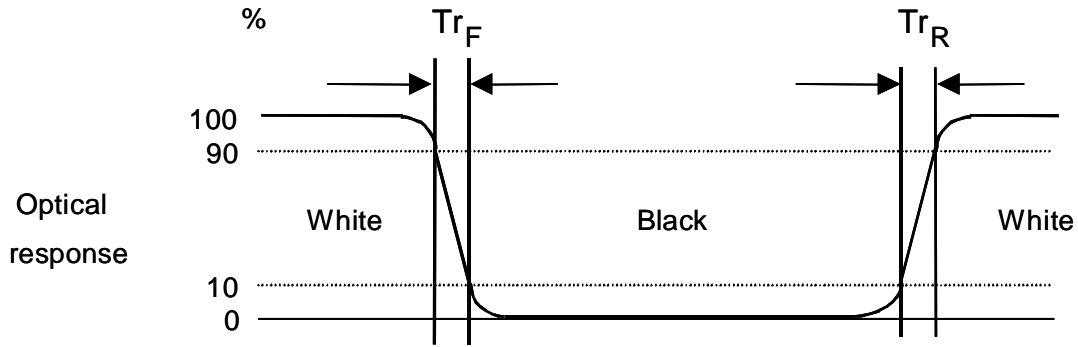

Note 2: Brightness uniformity of these 9 points is defined as below

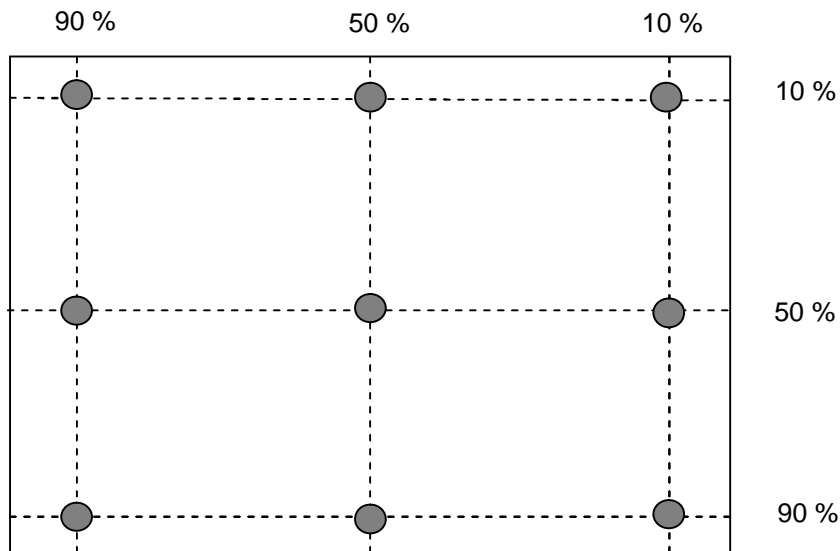

$$\text{Uniformity} = \frac{\text{Minimum Luminance in 9 points (1-9)}}{\text{Maximum Luminance in 9 Points (1-9)}} \times 100\%$$

Product Specification

Note 3: Crosstalk is defined as below :

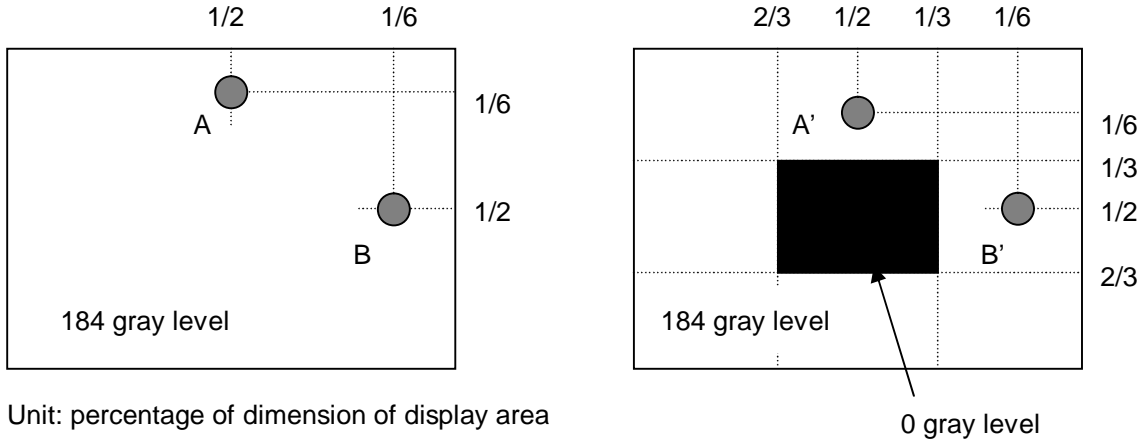

Unit: percentage of dimension of display area

$|L_A - L_{A'}| / L_A \times 100\% = 1.5\% \text{ max.}$, L_A and L_B are brightness at location A and B

$|L_B - L_{B'}| / L_B \times 100\% = 1.5\% \text{ max.}$, $L_{A'}$ and $L_{B'}$ are brightness at location A' and B'

Note 4: Test Patern: Subchecker Pattern at 127 gray level

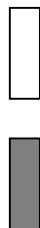
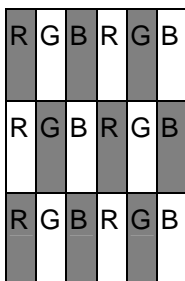
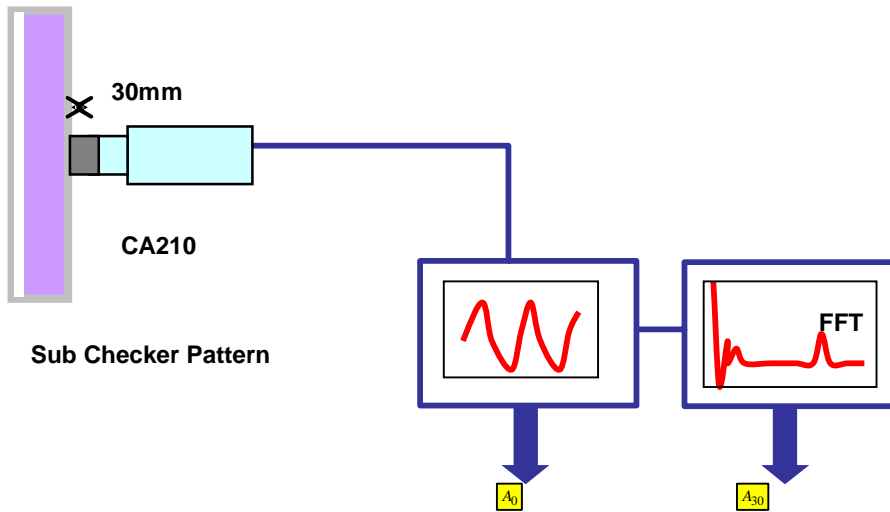

Gray Level = L127

Gray Level = L0

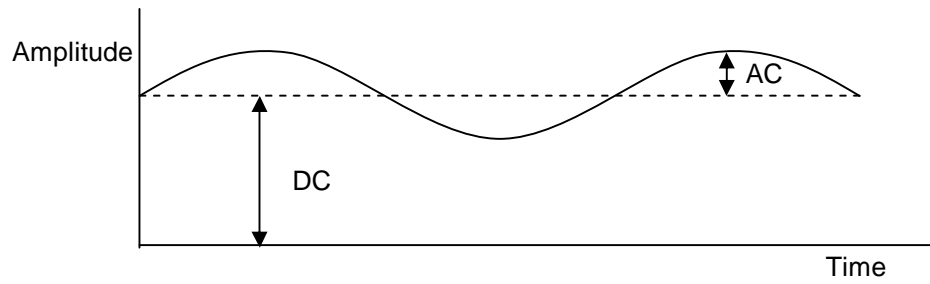

$$\text{Flicker (dB)} = 20 \log \frac{\text{AC Level(at 30 Hz)}}{\text{DC Level}}$$

3.0 Functional Block Diagram

The following diagram shows the functional block of the 15.0 inches wide Color TFT/LCD Module:

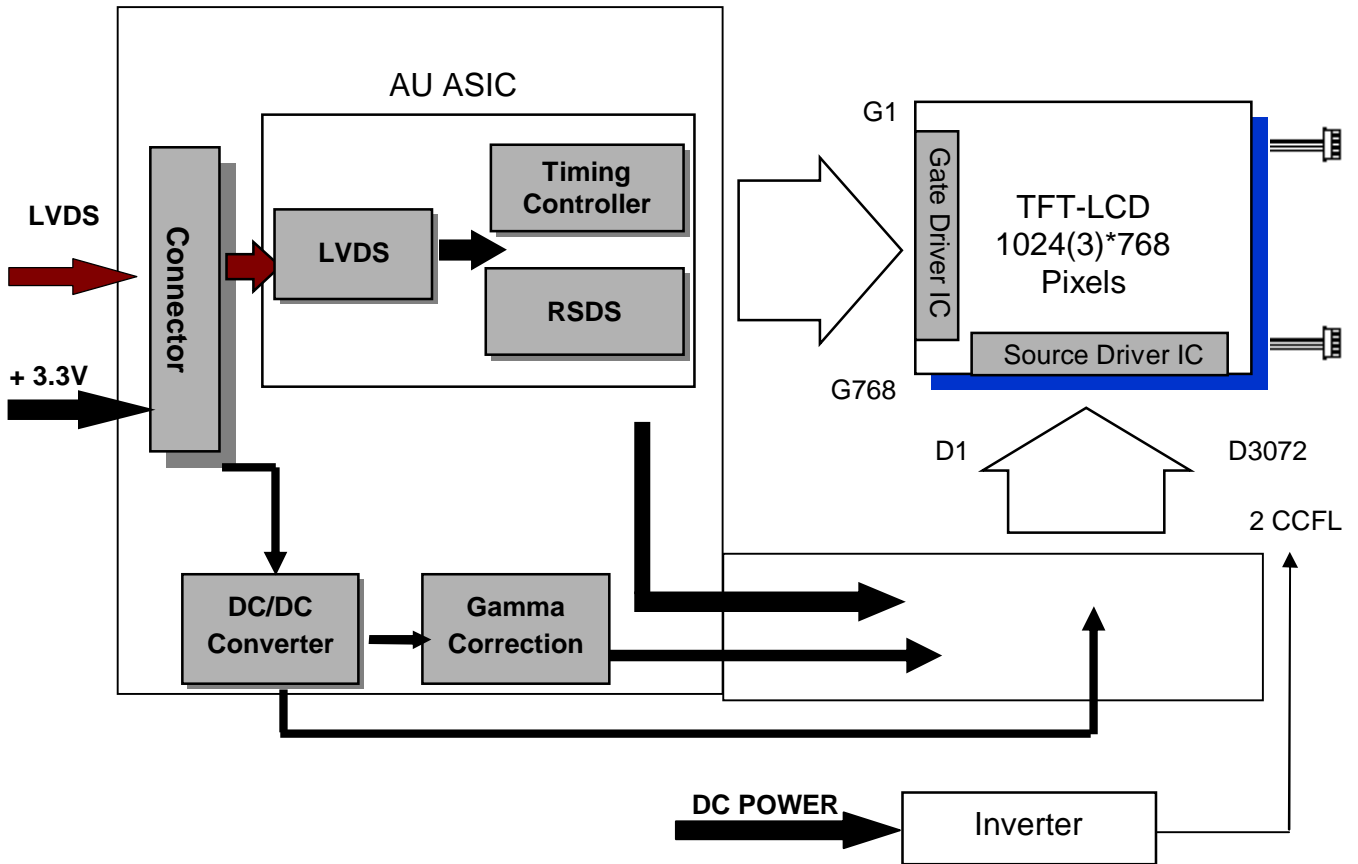

CWY20G – A0G16 / MSB240420

JST-BHR-03VS-1

Mating Type: HRS DF14-20S-1.25C

SM02(8.0)B-BHS-1-TB

4.0 Absolute Maximum Ratings

Absolute maximum ratings of the module are as below:

4.1 TFT LCD Module

Item	Symbol	Min	Max	Unit	Conditions
Logic/LCD Drive	VDD	0.3	+3.6	[Volt]	<i>Note 1,2</i>

4.2 Backlight Unit

Item	Symbol	Min	Max	Unit	Conditions
CCFL Current	IRCFL	-	7	[mA] rms	<i>Note 1,2</i>

4.3 Absolute Ratings of Environment

Item	Symbol	Min	Max	Unit	Conditions
Operating Temperature	TOP	0	+50	[°C]	<i>Note 3</i>
Operating Humidity	HOP	8	90	[%RH]	<i>Note 3</i>
Storage Temperature	TST	-20	+60	[°C]	<i>Note 3</i>
Storage Humidity	HST	8	90	[%RH]	<i>Note 3</i>

Note 1: With in Ta (25°C)

Note 2: Permanent damage to the device may occur if exceed maximum values.

Note 3: Please refer to the graph below for corresponding of temperature and humidity."

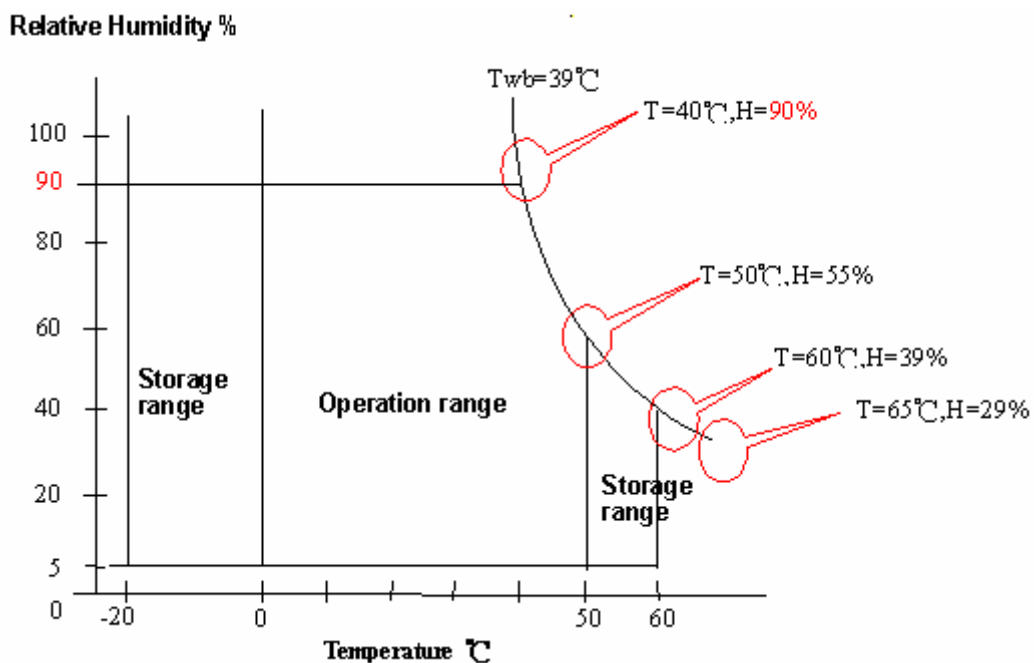

5.0 Electrical characteristics

5.1 TFT LCD Module

5.1.1 Power Specification

Input power specifications are as follows:

Symbol	Parameter	Min	Typ	Max	Units	Condition
VDD	Logic/LCD Drive Voltage	3.0	3.3	3.6	[Volt]	± 10%
IDD	VDD current	-	600	700	[mA]	Vin=3.3V , Gray Bar Pattern, at 60Hz
Irush	LCD Inrush Current	-	-	3	[A]	Note
PDD	VDD Power		2.0	2.3	[Watt]	Vin=3.3V , Gray Bar Pattern, at 60Hz
VDDrp	Allowable Logic/LCD Drive Ripple Voltage			100	[mV] p-p	Vin=3.3V , All Black Pattern, at 75Hz

Note: Measurement conditions:

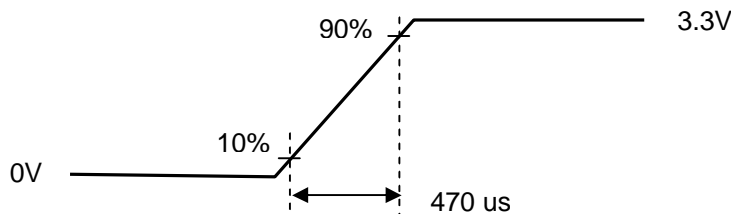
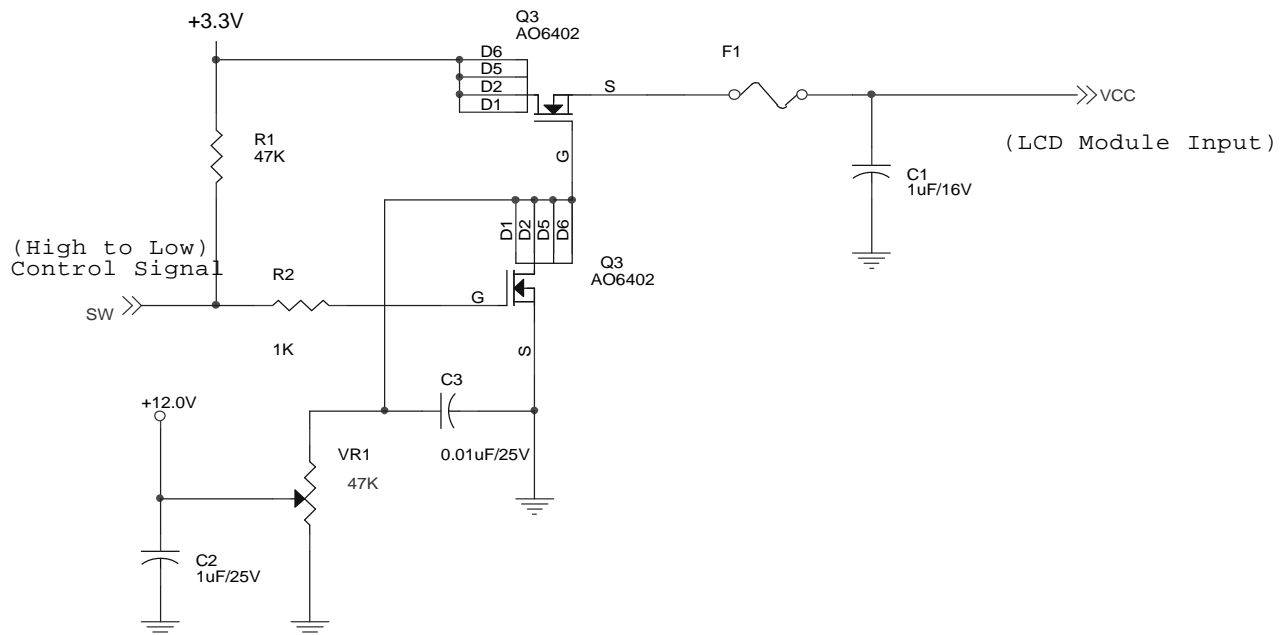

Vin rising time

5.1.2 Signal Electrical Characteristics

Input signals shall be low or Hi-Z state when V_{in} is off

It is recommended to refer the specifications of SN75LVDS82DGG (Texas Instruments) in detail.

Each signal characteristics are as follows;

Symbol	Parameter	Min	Typ	Max	Units	Condition	
VTH	Differential Input High Threshold	-	-	100	[mV]	$V_{ICM} = 1.2V$	Note
VTL	Differential Input Low Threshold	-100	-	-	[mV]	$V_{ICM} = 1.2V$	Note
VID	Input Differential Voltage	110	400	600	[mV]		Note
VICM	Differential Input Common Mode Voltage	1.1	-	1.45	[V]	$V_{TH}/V_{TL} = \pm 100mV$	Note

Note: LVDS Signal Waveform

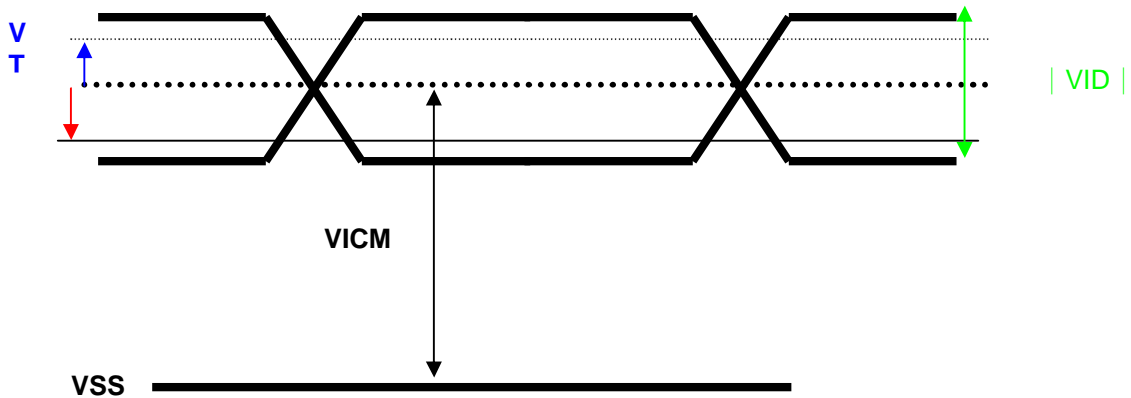

5.2 Parameter Guideline for CCFL

Following characteristics are measured under a stable condition using an inverter at 25°C (Room Temperature):

Symbol	Parameter	Min.	Typ.	Max.	Unit	Condition
IRCFL	CCFL operation range	2.5	6	7	[mA] rms	(Ta=25°C) Note 1, 2
ICFL	CCFL Inrush current	-	-	20	[mA]	
FCFL	CCFL Frequency	40	55	80	[KHz]	(Ta=25°C) Note 3
ViCFL (0°C) (reference)	CCFL Ignition Voltage		-	1450	[Volt] rms	(Ta=0°C) Note 4
ViCFL (25°C) (reference)	CCFL Ignition Voltage		-	1100	[Volt] rms	(Ta=25°C) Note 4
VCFL	CCFL Discharge Voltage	-	590 (@6mA)	710 (@2.5mA)	[Volt] rms	(Ta=25°C) Note 5
PCFL	CCFL Power consumption @7mA(inverter excluded)	-	7.1		[Watt]	(Ta=25°C) Note 5
Lamp Life		40,000	60,000		Hrs	(Ta=25°C) Note 2 IRCFL = 6mA

Note 1: IRCFL is defined as the return current of an inverter. (In Fig. 1)

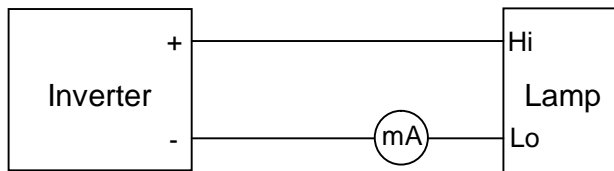

(Fig. 1: Measurement of return current)

A stable IRCFL is a current without flicker or biasing waveform provided by inverter that ensures the backlight perform to its specification. The ideal sine waveform should be symmetric in positive and negative polarities and the asymmetry rate of the inverter waveform should be below 10%.

It is recommended to use the inverter with detection circuit to avoid overvoltage, overcurrent, or mismatching waveform. The purpose is to avoid current flow into only one of the lamps when the other one is not in operation.

Note 2: The life time is defined as having expired when the brightness of the CCFL is reduced by half. Different inverter designs will result in different input currents, different degrees of leakage, and therefore different impacts on lamp life. Concerning the leakage generated from the LCD panel and the inverter, lamp life is defined as IRCFL equals 6mA and the input current does not exceed 7mA.

Note 3: CCFL frequency should be carefully determined to avoid interference between inverter and TFT LCD.

Note 4: CCFL inverter should be able to give output a voltage more than 1450 volt. Lamp units need 1450 volt minimum for ignition.

Note 5: Calculator value for reference (IRCFLxVCFLx2=PCFL).

6.0 Signal Characteristic

6.1 Pixel Format Image

Following figure shows the relationship of the input signals and LCD pixel format.

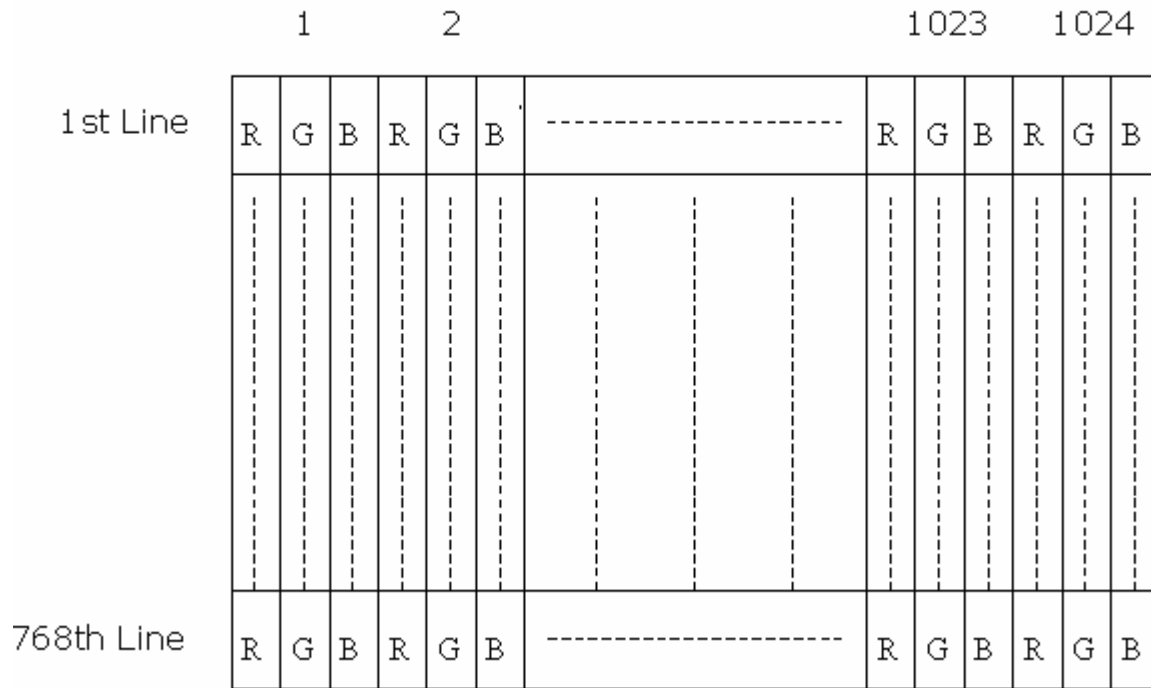

6.2 Input Data Format

SEL68="H" or "Floating" for 6 bits LVDS input

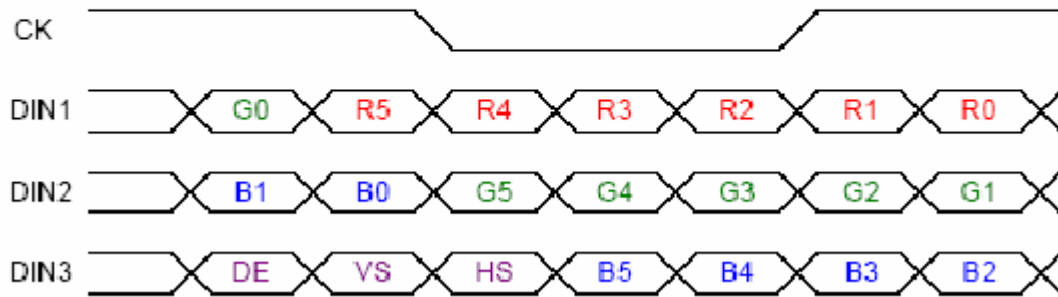

SEL68="L" for 8 bits LVDS input

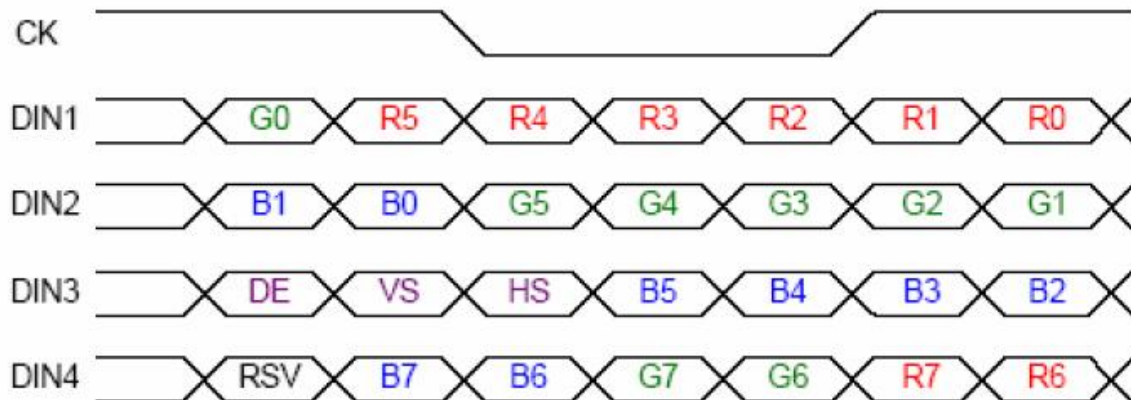

Note1: Please follow PSWG.

Note2: R/G/B data 7:MSB, R/G/B data 0:LSB

6.3 Signal Description

The module using a pair of LVDS receiver SN75LVDS82(Texas Instruments) or compatible. LVDS is a differential signal technology for LCD interface and high speed data transfer device. Transmitter shall be SN75LVDS83(negative edge sampling) or compatible. The first LVDS port(RxOxxx) transmits odd pixels while the second LVDS port(RxExxx) transmits even pixels.

CWY20G-A0D1T (PTWO) or MSB240420 (STM)		
Pin No.	Symbol	Description
1	VDD	Power Supply, 3.3V (typical)
2	VDD	Power Supply, 3.3V (typical)
3	VSS	Ground
4	VSS	Ground
5	Rin0-	- LVDS differential data input (R0-R5, G0)
6	Rin0+	+ LVDS differential data input (R0-R5, G0)
7	VSS	Ground
8	Rin1-	- LVDS differential data input (G1-G5, B0-B1)
9	Rin1+	+ LVDS differential data input (G1-G5, B0-B1)
10	VSS	Ground
11	Rin2-	- LVDS differential data input (B2-B5, HS, VS, DE)
12	Rin2+	+ LVDS differential data input (B2-B5, HS, VS, DE)
13	VSS	Ground
14	ClkIN-	- LVDS differential clock input
15	ClkIN+	+ LVDS differential clock input
16	VSS	Ground
17	Rin3-	- LVDS differential data input (R6-R7, G6-G7,B6-B7)
18	Rin3+	- LVDS differential data input (R6-R7, G6-G7,B6-B7)
19	VSS	Ground
20	SEL68	Selection for 6 bits/8bits LVDS data input * Note1

Note1: SEL68=" High" or "NC", accept 6 bits LVDS data input.

SEL68=" LOW", accept 8 bits LVDS data input.

6.4 Interface Timing

6.4.1 Timing Characteristics

Basically, interface timings described here is not actual input timing of LCD module but output timing of SN75LVDS82DGG (Texas Instruments) or equivalent.

Signal	Parameter	Symbol	MIN	TYP	MAX	Unit
Clock Timing	Clock frequency	clk	50	65	81	MHz
Hsync Timing	Horizontal active	Thd	1024	1024	1024	Tclk
	Horizontal blanking	Thbl	30	320	1024	Tclk
	Horizontal period	Th	1054	1344	2048	Tck
Vsync Timing	Vertical active	Tvd	768	768	768	Th
	Vertical blanking	Tvbl	8	38	256	Th
	Vertical period	Tv	776	806	1024	Th

Note: DE mode only

Note: Typical value refer to VESA STANDARD

6.4.2 Timing Diagram

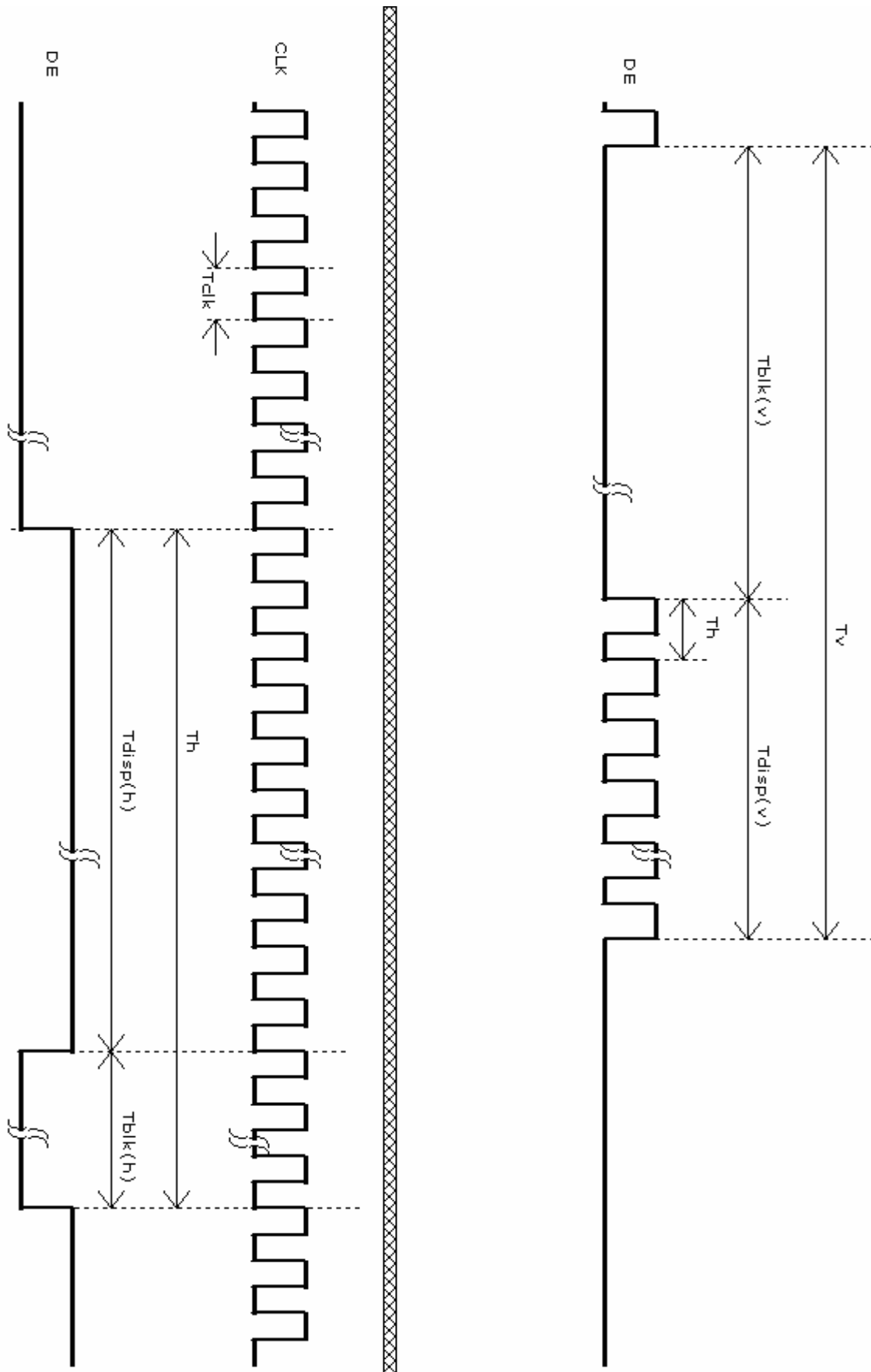

6.5 Power ON/OFF Sequence

Vin power and lamp on/off sequence is as follows. Interface signals are also shown in the chart. Signals from any system shall be Hi-Z state or low level when Vin is off.

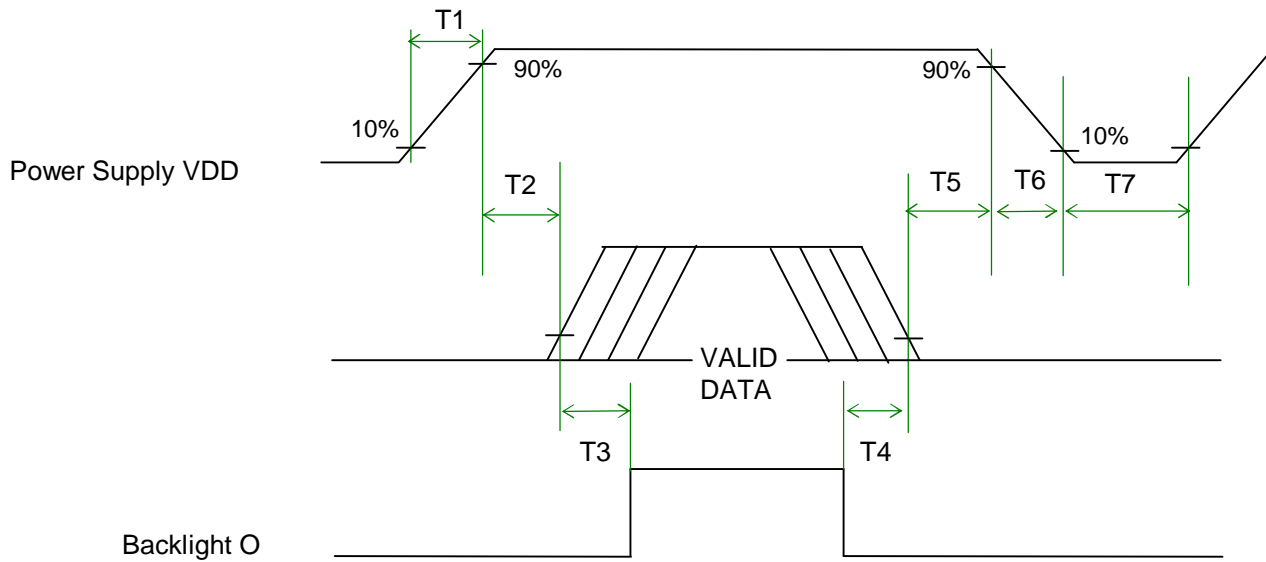

Power Sequence Timing

Parameter	Value			Unit
	Min.	Typ.	Max.	
T1	0.5	-	10	[ms]
T2	0	-	50	[ms]
T3	200	-	-	[ms]
T4	100	-	-	[ms]
T5	0	-	50	[ms]
T6	-	-	10	[ms]
T7	1000	-	-	[ms]

7.0 Connector & Pin Assignment

Physical interface is described as for the connector on module.

These connectors are capable of accommodating the following signals and will be following components.

7.1 TFT LCD Module

Connector Name / Designation	Interface Connector / Interface card
Manufacturer	P-TWO or compatible
Type Part Number	CWY20G – A0G16 / MSB240420
Mating Housing Part Number	HRS DF14-20S-1.25C

Pin#	Signal Name	Pin#	Signal Name
1	VDD	2	VDD
3	VSS	4	VSS
5	Rin0-	6	Rin0+
7	VSS	8	Rin1-
9	Rin1+	10	VSS
11	Rin2-	12	Rin2+
13	VSS	14	ClkIN-
15	ClkIN+	16	VSS
17	Rin3-	18	Rin3+
19	VSS	20	VSS

7.1.1 Connector Illustration

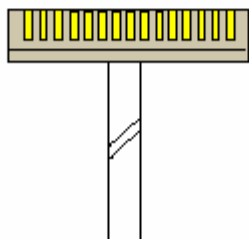
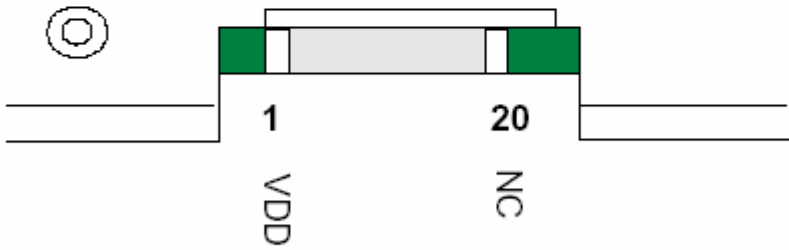
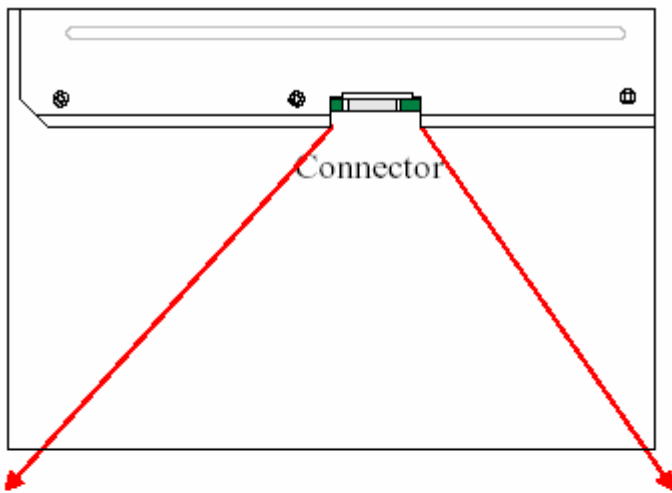
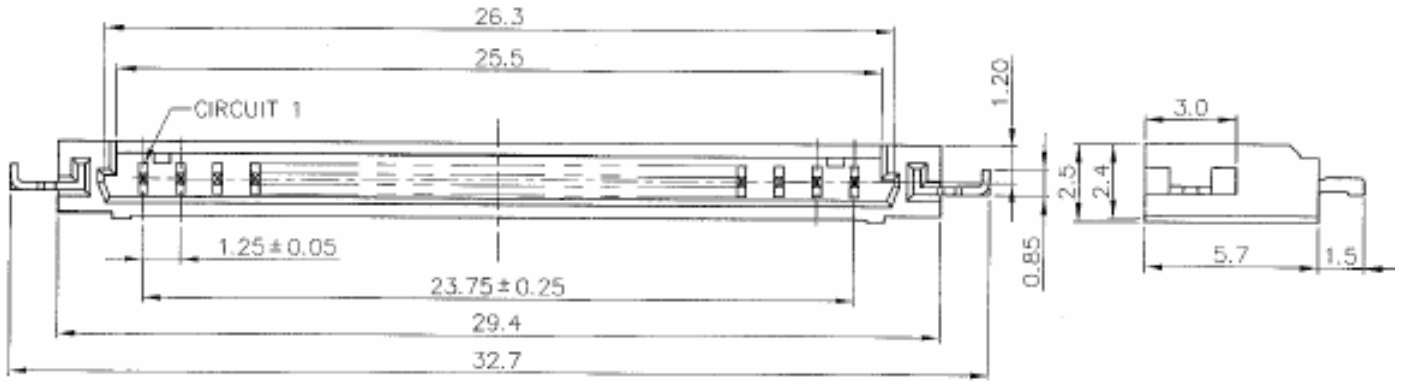

7.2 Backlight Unit

Connector Name / Designation	Lamp Connector
Manufacturer	JST or compatible
Type / Part Number	BHR-03VS-1
Mating Type / Part Number	SM02(8.0)B-BHS-1-TB

7.3 Signal for Lamp Connector

Pin	Symbol	Description
1	HV	Lamp High Voltage
2	NC	No Connection
3	LV	Ground

- ⌌ Cable length: 140 ± 5 mm
- ⌌ Connector-output position: right side (front view)
- ⌌ Lamp assembly design shall be easy for replacement and repair

8.0 Reliability

Reliability test condition

No	Test Item	Test Condition
1	Temperature Humidity Bias (THB)	50°C , 80%, 300hours
2	High Temperature Operation (HTO)	50°C , 300hours
3	Low Temperature Operation (LTO)	0°C , 300hours
4	High Temperature Storage (HTS)	60°C , 300hours
5	Low Temperature Storage (LTS)	-20°C , 300hours
6	Thermal Shock Test (TST)	-20°C/30min, 60°C/30min, 100 cycles
7	On/Off Test	On/10sec, Off/10sec, 30,000 cycles
8	Shock Test (Non-Operating)	50G, 20ms, Half-sine wave (+ X, +Y, +Z)
9	Vibration Test (Non-Operating)	1.5G(10~200Hz P- P), 30 Minutes each Axis (X, Y, Z)
10	ESD (Electro-Static Discharge)	Contact Discharge: ± 8KV, 150pF(330Ω) 1sec, 8 points, 25 times/ point Air Discharge: ± 15KV, 150pF(330Ω) 1sec, 8 points, 25 times/ point
11	Drop Test	The drop height is 60cm

9.0 Shipping and Packing

9-1 Shipping Label Format



9-2 Carton Package

LCD module set

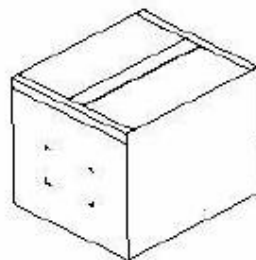
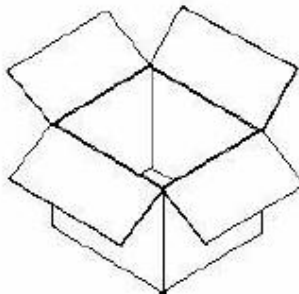
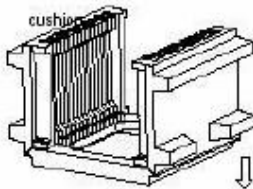

Notes:

1. Max Capacity: 10 LCD module/Carton
2. Max Weight: 14kg/Carton
3. The outside dimension of carton is 490(L)mmx390(W)mmx360(H)mm

10.0 Safety

10.1 Sharp Edge Requirements

There will be no sharp edges or comers on the display assembly that could cause injury.

10.2 Materials

10.2.1 Toxicity

There will be no carcinogenic materials used anywhere in the display module. If toxic materials are used, they will be reviewed and approved by the responsible AUO Toxicologist.

10.2.2 Flammability

All components including electrical components that do not meet the flammability grade UL94-V1 in the module will complete the flammability rating exception approval process.

The printed circuit board will be made from material rated 94-V1 or better. The actual UL flammability rating will be printed on the printed circuit board.

10.3 Capacitors

If any polarized capacitors are used in the display assembly, provisions will be made to keep them from being inserted backwards.

11.0 Other Requirement

11.1 National Test Lab Requirement

The display module will satisfy all requirements for compliance to

UL 1950, First Edition
CSA C22.2 No.950-M89
EEC 950
EN 60 950

U.S.A. Information Technology Equipment
 Canada, Information Technology Equipment
 International, Information Technology Equipment
 International, Information Processing Equipment
 (European Norm for IEC950)

12.0 Mechanical Characteristics

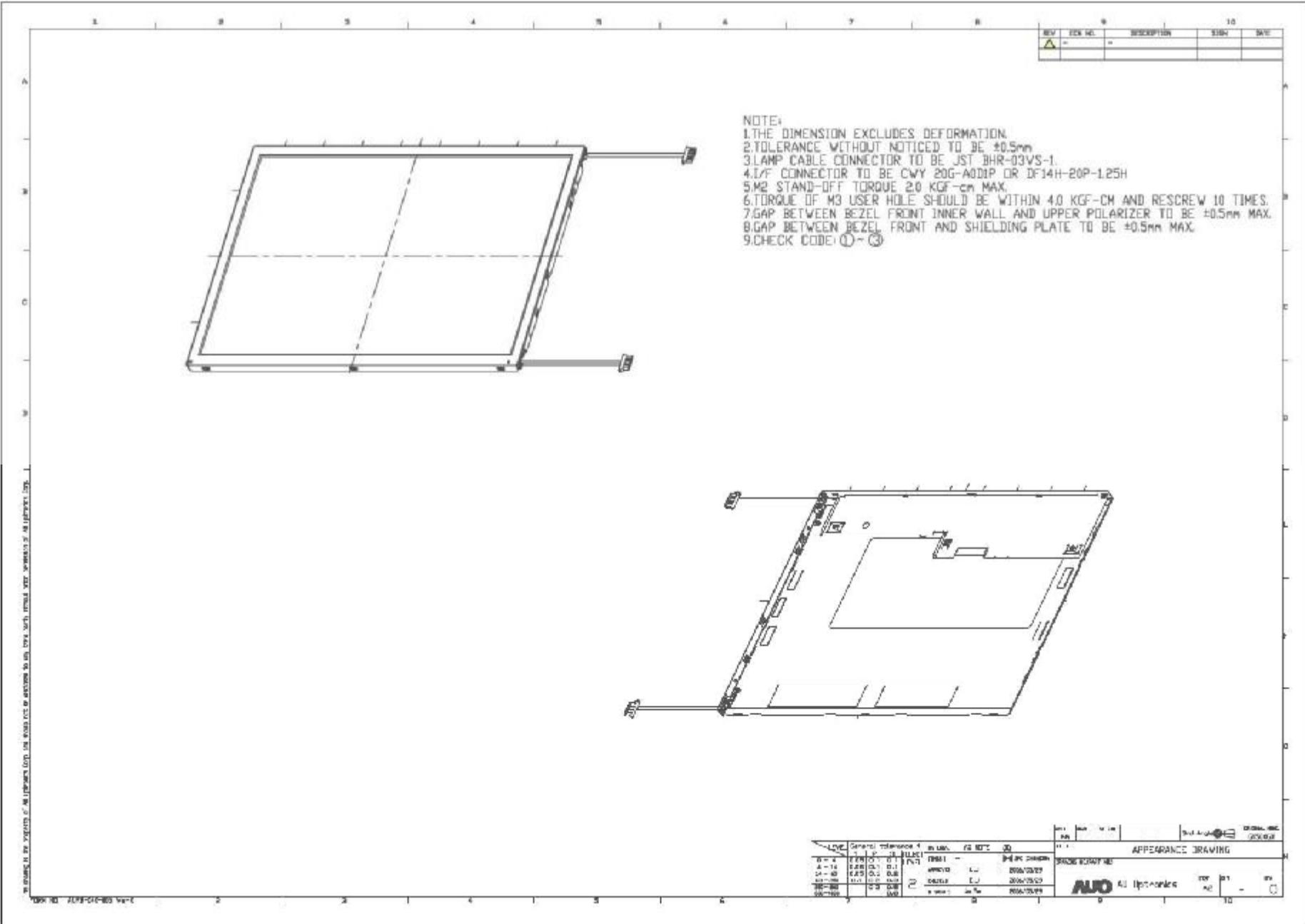

REV	DATE	DESCRIPTION	BY	CHK
1				

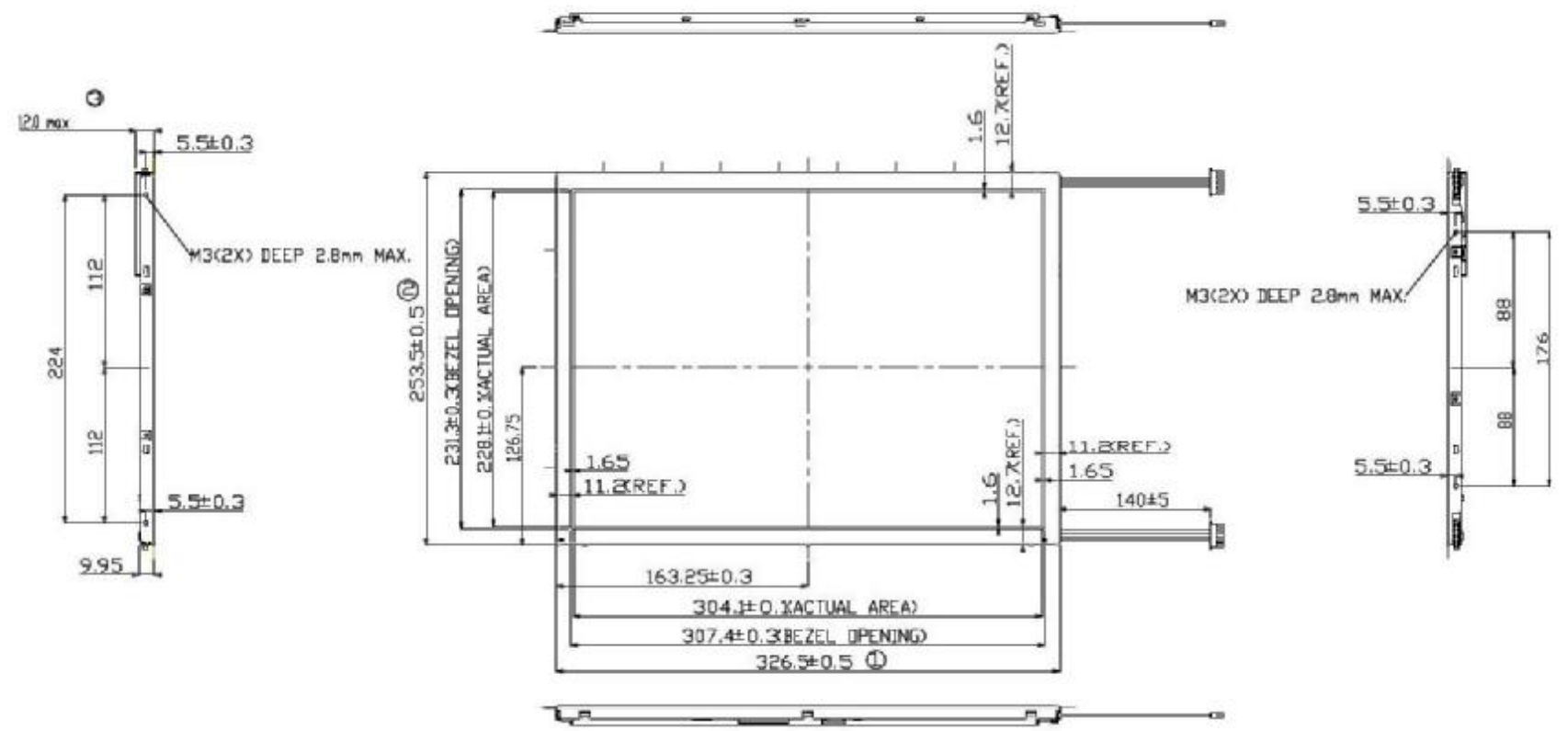

The provided is the property of AU Electronics Corp. and should not be disclosed to any third party without prior permission of AU Electronics Corp.

REV	DATE	DESCRIPTION	BY	CHK
1				

REV	DATE	DESCRIPTION	BY	CHK
1				

REV	DATE	DESCRIPTION	BY	CHK
1				

REV	DATE	DESCRIPTION	BY	CHK
1				

REV	DATE	DESCRIPTION	BY	CHK
1				

REV	DATE	DESCRIPTION	BY	CHK
1				

REV	DATE	DESCRIPTION	BY	CHK
1				

REV	DATE	DESCRIPTION	BY	CHK
1				

