

Standard Sinterglass Diode

Features

- High temperature metallurgically bonded constructed rectifiers
- Cavity-free glass passivated junction in DO-204AP package
- Hermetically sealed package
- 1.0 ampere operation at $T_{amb} = 100\text{ }^{\circ}\text{C}$ with no thermal runaway

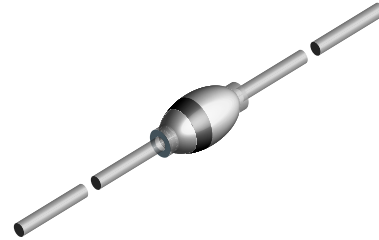

17031

Mechanical Data

Case: DO-204AP Sintered glass case

Terminals: Solder plated axial leads, solderable per MIL-STD-750, Method 2026

Mounting Position: Any

Weight: approx. 560 mg

Polarity: Color band denotes cathode end

Parts Table

Part	Type differentiation	Package
G1A	$V_{RRM} = 50\text{ V}$	DO-204AP(G-1)
G1B	$V_{RRM} = 100\text{ V}$	DO-204AP(G-1)
G1D	$V_{RRM} = 200\text{ V}$	DO-204AP(G-1)
G1G	$V_{RRM} = 400\text{ V}$	DO-204AP(G-1)
G1J	$V_{RRM} = 600\text{ V}$	DO-204AP(G-1)
G1K	$V_{RRM} = 800\text{ V}$	DO-204AP(G-1)
G1M	$V_{RRM} = 1000\text{ V}$	DO-204AP(G-1)

Absolute Maximum Ratings

$T_{amb} = 25\text{ }^{\circ}\text{C}$, unless otherwise specified

Parameter	Test condition	Part	Symbol	Value	Unit
Reverse voltage = Repetitive peak reverse voltage	see electrical characteristics	G1A	$V_R = V_{RRM}$	50	V
		G1B	$V_R = V_{RRM}$	100	V
		G1D	$V_R = V_{RRM}$	200	V
		G1G	$V_R = V_{RRM}$	400	V
		G1J	$V_R = V_{RRM}$	600	V
		G1K	$V_R = V_{RRM}$	800	V
		G1M	$V_R = V_{RRM}$	1000	V
Maximum average forward rectified current	0.375 " (9.5 mm) lead length at $T_{amb} = 100\text{ }^{\circ}\text{C}$		$I_{F(AV)}$	1.0	A

Parameter	Test condition	Part	Symbol	Value	Unit
Peak forward surge current	8.3 ms single half sine-wave superimposed on rated load (JEDEC Method)		I_{FSM}	50	A
Maximum full load reverse current	full cycle average 0.375 " (9.5 mm) lead length at $T_{amb} = 100\text{ }^{\circ}\text{C}$		$I_{R(AV)}$	200	μA
Operating junction and storage temperature range			T_J, T_{STG}	- 55 to + 175	$^{\circ}\text{C}$

Maximum Thermal Resistance

$T_{amb} = 25\text{ }^{\circ}\text{C}$, unless otherwise specified

Parameter	Test condition	Symbol	Value	Unit
Typical thermal resistance ¹⁾		$R_{\theta JL}$	55	K/W

¹⁾ Thermal resistance from junction to ambient at 0.375 " (9.5 mm) lead length, P.C.B. mounted

Electrical Characteristics

$T_{amb} = 25\text{ }^{\circ}\text{C}$, unless otherwise specified

Parameter	Test condition	Part	Symbol	Min	Typ.	Max	Unit
Maximum instantaneous forward voltage	$I_F = 1\text{ A}$	G1A	V_F			1.2	V
		G1B	V_F			1.2	V
		G1D	V_F			1.1	V
		G1G	V_F			1.1	V
		G1J	V_F			1.1	V
		G1K	V_F			1.1	V
		G1M	V_F			1.1	V
Maximum reverse current	$V_R = V_{RRM}, T_{amb} = 25\text{ }^{\circ}\text{C}$		I_R			2.0	μA
	$V_R = V_{RRM}, T_{amb} = 150\text{ }^{\circ}\text{C}$		I_R			100	μA
Typical reverse recovery time	$I_F = 0.5\text{ A}, I_R = 1.0\text{ A}, I_{rr} = 0.25\text{ A}$		t_{rr}		1.5		μs
Typical junction capacitance	$V_R = 4.0\text{ V}, f = 1\text{ MHz}$		C_j		15		pF

Typical Characteristics ($T_{amb} = 25\text{ }^{\circ}\text{C}$ unless otherwise specified)

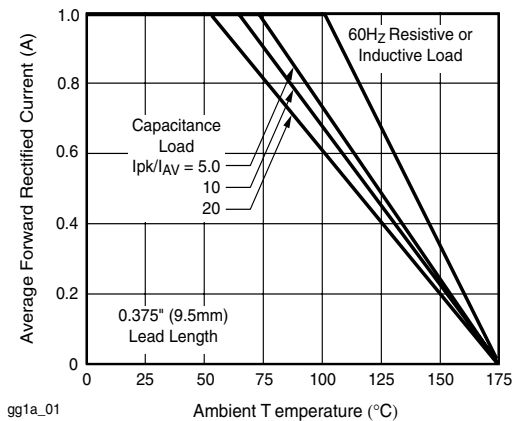

Figure 1. Forward Current Derating Curve

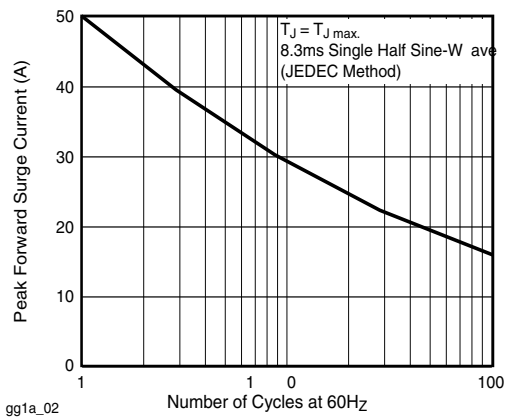

Figure 2. Maximum Non-Repetitive Peak Forward Surge Current

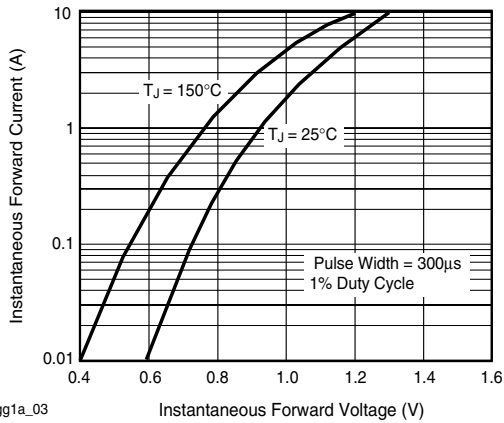

Figure 3. Typical Instantaneous Forward Characteristics

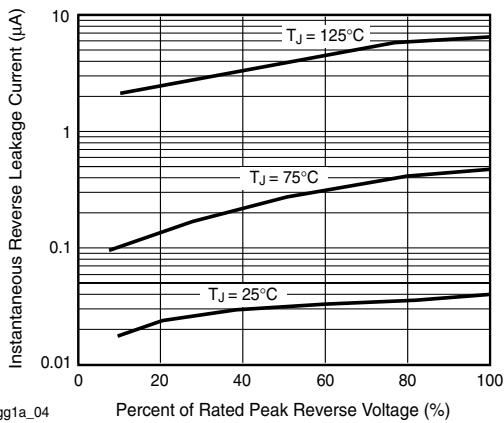

Figure 4. Typical Reverse Characteristics

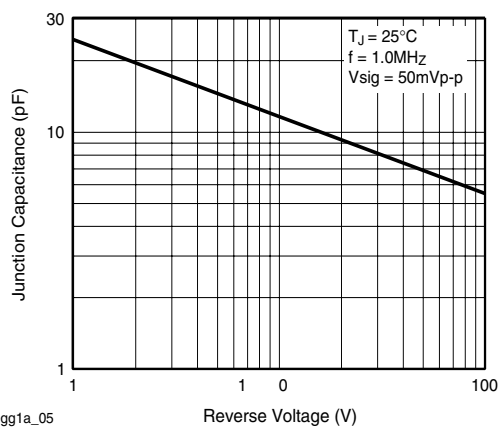
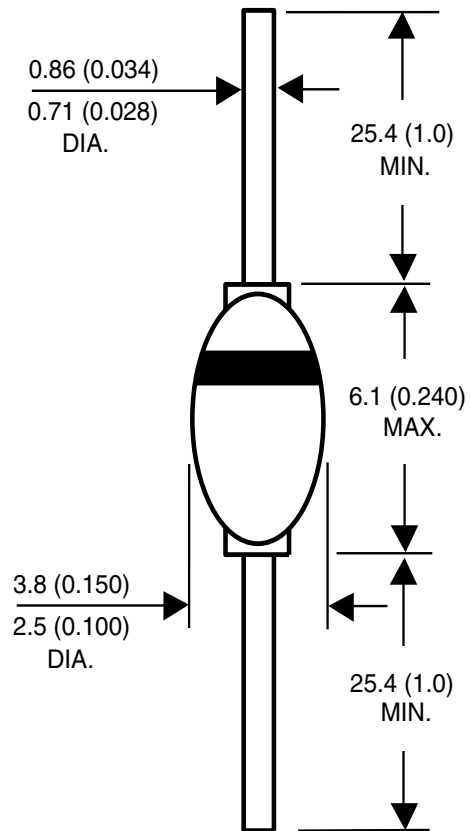

Figure 5. Typical Junction Capacitance

Package Dimensions in mm (Inches)



17030



Ozone Depleting Substances Policy Statement

It is the policy of **Vishay Semiconductor GmbH** to

1. Meet all present and future national and international statutory requirements.
2. Regularly and continuously improve the performance of our products, processes, distribution and operating systems with respect to their impact on the health and safety of our employees and the public, as well as their impact on the environment.

It is particular concern to control or eliminate releases of those substances into the atmosphere which are known as ozone depleting substances (ODSs).

The Montreal Protocol (1987) and its London Amendments (1990) intend to severely restrict the use of ODSs and forbid their use within the next ten years. Various national and international initiatives are pressing for an earlier ban on these substances.

Vishay Semiconductor GmbH has been able to use its policy of continuous improvements to eliminate the use of ODSs listed in the following documents.

1. Annex A, B and list of transitional substances of the Montreal Protocol and the London Amendments respectively
2. Class I and II ozone depleting substances in the Clean Air Act Amendments of 1990 by the Environmental Protection Agency (EPA) in the USA
3. Council Decision 88/540/EEC and 91/690/EEC Annex A, B and C (transitional substances) respectively.

Vishay Semiconductor GmbH can certify that our semiconductors are not manufactured with ozone depleting substances and do not contain such substances.

**We reserve the right to make changes to improve technical design
and may do so without further notice.**

Parameters can vary in different applications. All operating parameters must be validated for each customer application by the customer. Should the buyer use Vishay Semiconductors products for any unintended or unauthorized application, the buyer shall indemnify Vishay Semiconductors against all claims, costs, damages, and expenses, arising out of, directly or indirectly, any claim of personal damage, injury or death associated with such unintended or unauthorized use.

Vishay Semiconductor GmbH, P.O.B. 3535, D-74025 Heilbronn, Germany
Telephone: 49 (0)7131 67 2831, Fax number: 49 (0)7131 67 2423



Disclaimer

All product specifications and data are subject to change without notice.

Vishay Intertechnology, Inc., its affiliates, agents, and employees, and all persons acting on its or their behalf (collectively, "Vishay"), disclaim any and all liability for any errors, inaccuracies or incompleteness contained herein or in any other disclosure relating to any product.

Vishay disclaims any and all liability arising out of the use or application of any product described herein or of any information provided herein to the maximum extent permitted by law. The product specifications do not expand or otherwise modify Vishay's terms and conditions of purchase, including but not limited to the warranty expressed therein, which apply to these products.

No license, express or implied, by estoppel or otherwise, to any intellectual property rights is granted by this document or by any conduct of Vishay.

The products shown herein are not designed for use in medical, life-saving, or life-sustaining applications unless otherwise expressly indicated. Customers using or selling Vishay products not expressly indicated for use in such applications do so entirely at their own risk and agree to fully indemnify Vishay for any damages arising or resulting from such use or sale. Please contact authorized Vishay personnel to obtain written terms and conditions regarding products designed for such applications.

Product names and markings noted herein may be trademarks of their respective owners.