



DDR Termination Regulator

Features

- Operation Supply Voltage: 1.6V to 5.5V
- Low Supply Current: 280 μ A @ 2.5V
- Low Output Offset
- Source and Sink Current
- Low External Component Count
- No Inductor Required
- No external Resistors Required
- Thermal Shutdown Protection
- SOP-8L package

Applications

- DDR-SDRAM Termination Voltage
- DDR-I / DDR-II Termination Voltage
- SSTL-2
- SSTL-3

General Description

The G2993 is a linear regulator designed to meet the JEDEC SSTL-2 and SSTL-3 (Series Stub Termination Logic) specifications for termination of DDR-SDRAM. It contains a high-speed operational amplifier that provides excellent response to the load transients. This device can deliver 1.5A continuous current and transient peaks up to 3A in the application as required for DDR-SDRAM termination.

The G2993 can easily provide the accurate V_{TT} voltages without external resistors that PCB areas can be reduced. The quiescent current is as low as 280 μ A @ 2.5V. So the power consumption can meet the low power consumption applications.

Ordering Information

ORDER NUMBER	MARKING	TEMP. RANGE	PACKAGE
G2993P1X	G2993	-40°C to 85°C	SOP- 8L

Note: X Specify the packing type

U: Tape & Reel

T: Tube

Pin Configuration

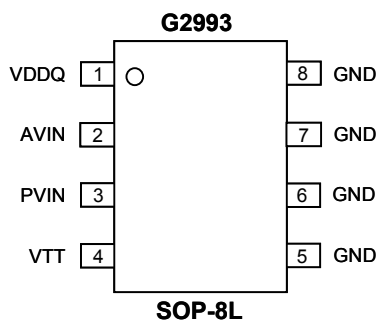

Typical Application Circuit

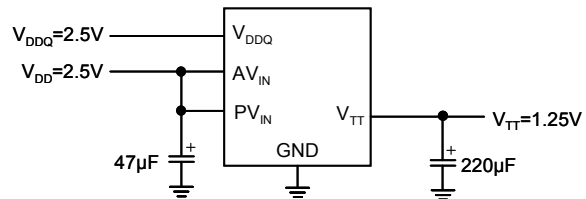

**Absolute Maximum Ratings** ⁽¹⁾

Supply Voltage	PVIN, AVIN, VDDQ to GND.....	-0.3V to +6V
Operating Ambient Temperature Range	T _A	-40°C to +125°C
Maximum Junction Temperature, T _J		150°C
Storage Temperature Range, T _{STG}		-65°C to +150°C
Soldering Temperature, 10seconds, T _S		260°C
Electrostatic Discharge, V _{ESD}		
Human body mode.....		2000V ⁽²⁾
SOP-8L Thermal Resistance (θ_{JA}).....		50°C/W

Recommend Operation Range

Operating Ambient Temperature Range	T _A	-40°C to +85°C
AVIN to GND.....		1.6V to +5.5V
PVIN, VDDQ to GND.....		1.6V to AVIN

Note:

⁽¹⁾: Absolute maximum rating indicates limits beyond which damage to the device may occurs.

⁽²⁾: Human body model : C = 100pF, R = 1500Ω, 3 positive pulses plus 3 negative pulses

Electrical Characteristics

Specifications with standard typeface are for T_A=25°C. Unless otherwise specified, AVIN=PVIN=2.5V, VDDQ=2.5V

SYMBOL	PARAMETER	CONDITION	MIN	TYP	MAX	UNIT
V _{TT}	V _{TT} Output voltage	I _{OUT} =0A				
		VDDQ=2.3V	1.115	1.15	1.19	V
		VDDQ=2.5V	1.215	1.25	1.29	V
		VDDQ=2.7V	1.315	1.35	1.39	V
		I _{OUT} =±1.5A				
		VDDQ=2.3V	1.115	1.15	1.19	V
		VDDQ=2.5V	1.215	1.25	1.29	V
		VDDQ=2.7V	1.315	1.35	1.39	V
I _Q	Quiescent Current	I _{OUT} =0A	120	280	500	μA
Z _{VDDQ}	VDDQ input Impedence			100		KΩ
T _{SD}	Thermal Shutdown			150		°C
	Thermal Shutdown Hysteresis			25		°C



Typical Performance Characteristics

$AV_{IN}=2.5V$, $PV_{IN}=2.5V$, $V_{DDQ}=2.5V$, $C_{AVIN}=0.1\mu F$, $C_{PVIN}=47\mu F$, $C_{VTT}=220\mu F$, $T_A=25^\circ C$, unless otherwise noted.

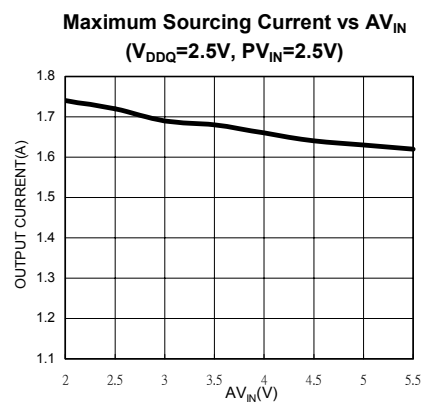
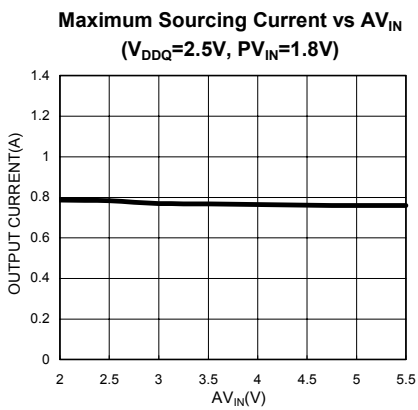
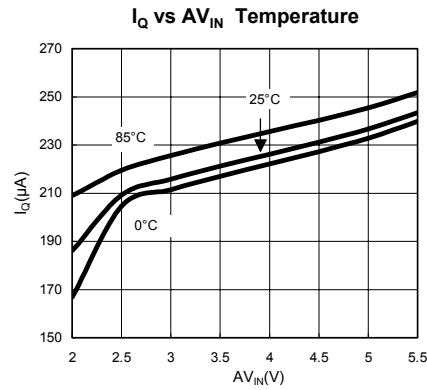
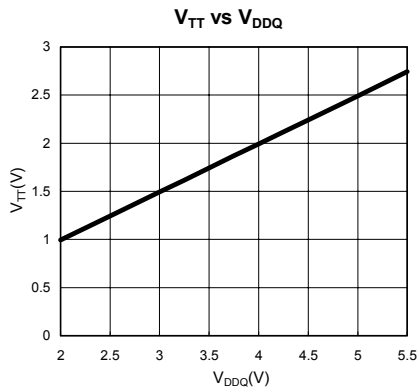
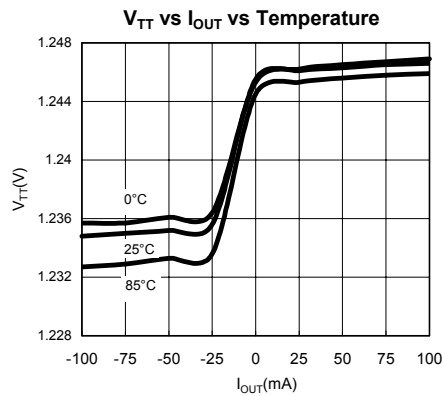
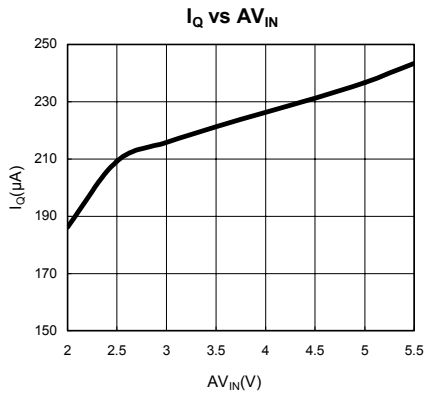



Typical Performance Characteristics (continued)

$AV_{IN}=2.5V$, $PV_{IN}=2.5V$, $V_{DDQ}=2.5V$, $C_{AVIN}=0.1\mu F$, $C_{PVIN}=47\mu F$, $C_{VTT}=220\mu F$, $T_A=25^\circ C$, unless otherwise noted.

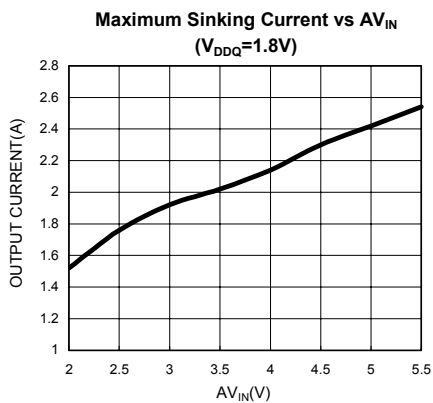
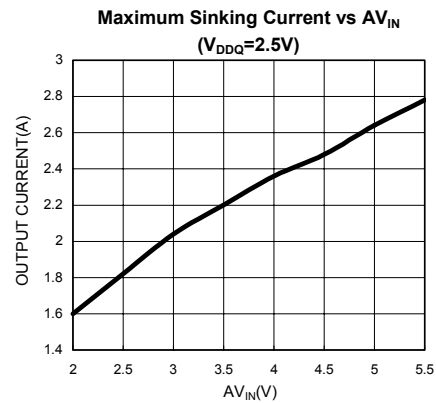
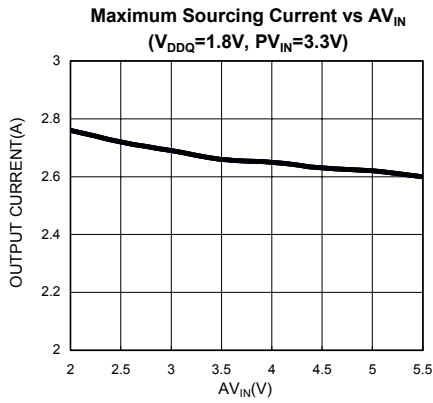
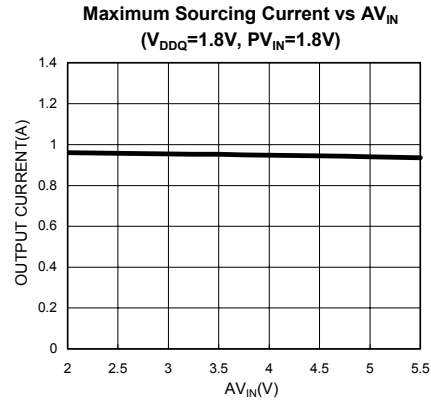
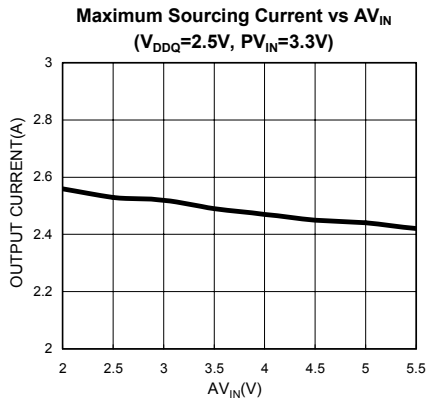



Typical Performance Characteristics (continued)

$V_{IN}=2.5V$, $P_{VIN}=2.5V$, $V_{DDQ}=2.5V$, $C_{AVIN}=0.1\mu F$ / Ceramic X7R/0603/6.3V/TDK, $C_{PVIN}=1000\mu F$ /Dip Electrolytic/10*12.5mm/6.3V/JACKCON, $C_{VTT}=1000\mu F$ *3/Dip Electrolytic/10*12.5mm/6.3V/JACKCON, $T_A=25^\circ C$, unless otherwise noted.

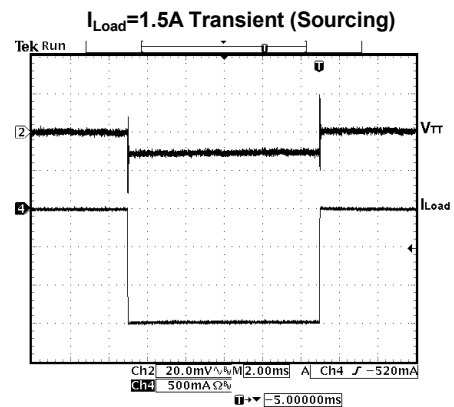
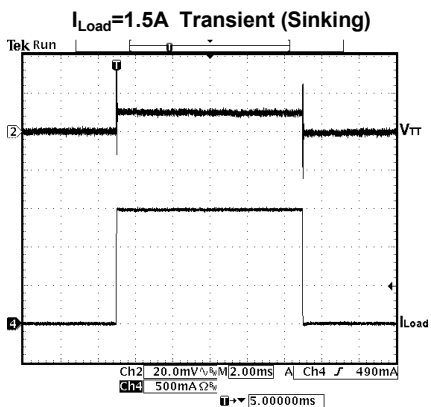
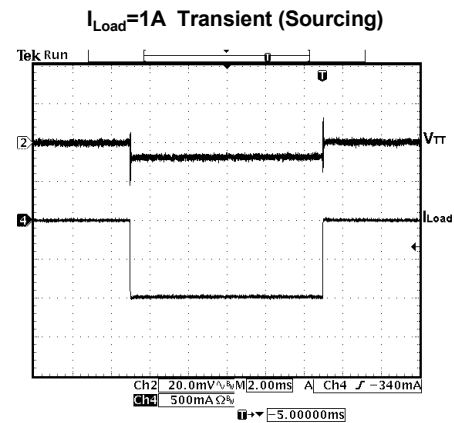
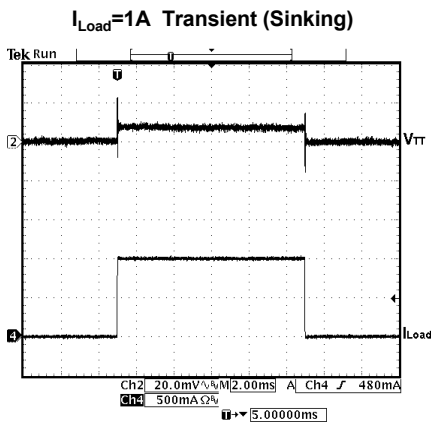
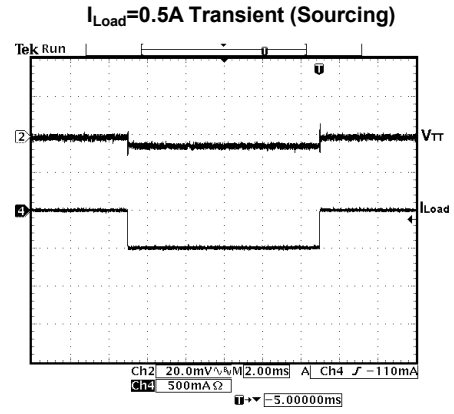
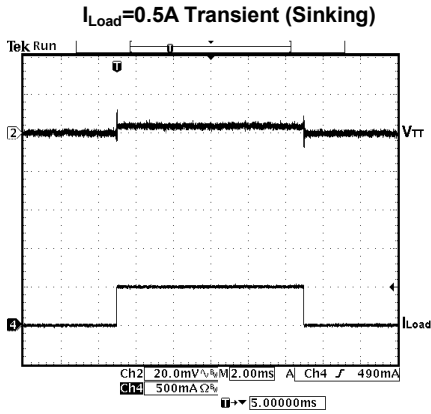

Pin Description

NUMBER	NAME	FUNCTION
1	VDDQ	Input for internal reference which equals to $VDDQ/2$
2	AVIN	Analog input pin
3	PVIN	Power input pin
4	VTT	Output voltage for connection to termination resistors, equal to $VDDQ/2$
5	GND	Ground
6	GND	Ground
7	GND	Ground
8	GND	Ground

Block Diagram

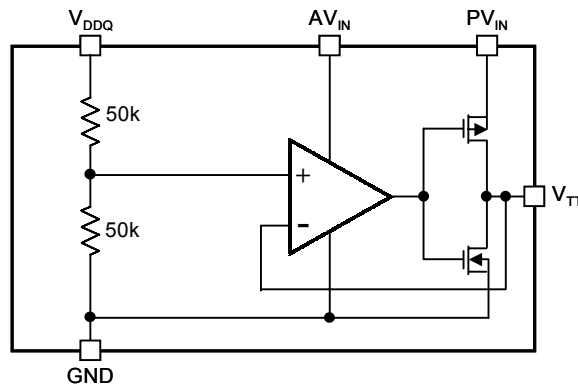

Description

The G2993 is a linear bus termination regulator designed to meet the JEDEC SSTL-2 and SSTL-3 (Series Stub Termination Logic) specifications for termination of DDR-SDRAM. The output, V_{TT} , is capable of sinking and sourcing current while regulating the output voltage equal to $VDDQ/2$. The G2993 is designed to maintain the excellent load regulation and with fast response time to minimum the transition preventing shoot-through. The G2993 also incorporates two distinct power rails that separates the analog circuitry (AVIN) from the power output stage (PVIN). This power rails split can be utilized to reduce the internal power dissipation. And this also permits G2993 to provide a termination solution for the next generation of DDR-SDRAM (DDR II).

Series Stub Termination Logic (SSTL) was created to improve signal integrity of the data transmission across the memory bus. This termination scheme is essential to prevent data error from signal reflections while transmitting at high frequencies encountered with DDR-SDRAM. The most common form of termination is Class II single parallel termination. This involves one R_S series resistor from the chipset to the memory and one R_T termination resistor, both 25Ω typically. The resistors can be changed to scale the current requirements from the G2993. This implementation can be seen below in Figure 1.

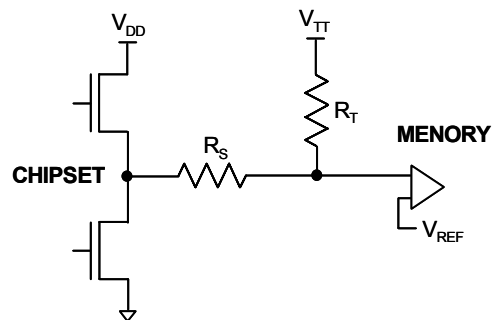

Figure 1. SSTL-Termination Scheme

AVIN, PVIN

AVIN and PVIN are two independent input supply pins for the G2993. AVIN is used to supply all the internal analog circuits. PVIN is only used to supply the output stage to create the regulated V_{TT} . To keep the regulation successfully, AVIN should be equal to or larger than PVIN. Using a higher PVIN voltage will produce a larger sourcing capability from V_{TT} . But the internal power loss will also increase and then the heat increases. If the junction temperature exceeds the thermal shutdown threshold than the G2993 will enter the shutdown state, where V_{TT} is tri-state. For SSTL-2 applications, the AVIN and PVIN can be short together at 2.5V to minimize the PCB complexity and to reduce the bypassing capacitors for the two supply pins separately.

**VDDQ**

A voltage divider of two 50kΩ is connected between VDDQ and ground, to create the internal reference voltage (VDDQ/2). This guarantees that V_{TT} will track VDDQ/2 precisely. The optimal implementation of VDDQ is as a remote sensing. This can be achieved by connecting VDDQ directly to the 2.5V rail (SSTL-2 applications) at the DIMM instead of AVIN and PVIN. This will ensure that the reference voltage tracks the DDR memory rails precisely without a large voltage drop from the power lines.

 V_{TT}

V_{TT} is the regulated output that is used to terminate the bus resistors of DDR-SDRAM. It can precisely track the VDDQ/2 voltage with the sinking and sourcing current capability. The G2993 is designed to deliver 1.5A continuous current and peak current up to 3A with a fast transient response @ 2.5V supply rail. The maximum continuous current sourcing from V_{TT} is a function of PVIN. Using a higher PVIN will increase the source current from V_{TT} , but it also increase the internal power dissipation and reduce the efficiency. Although the G2993 can deliver the larger current, care should be taken for the thermal dissipation when larger current is required. The R_{DS} of MOS will increase when the junction temperature increases. If the heat is not dealt with well, the maximum output current will be degraded. When the temperature exceeds the junction temperature, the thermal shutdown protection is activated. That will drive the V_{TT} output into tri-state until the temperature returns below the hysteretic trigger point.

Capacitors

The G2993 does not require the capacitors for input stability, but it is recommended for improving the performance during large load transition to prevent the input power rail from dropping, especially for PVIN. The input capacitor for PVIN should be as close as

possible. The typical recommended value is 50μF for AL electrolytic capacitors, 10uF with X5R for the ceramic capacitors. To prevent the excessive noise coupling into this device, an additional 0.1μF ceramic capacitor can be placed on the AVIN power rail for the better performance.

The output capacitor of the G2993 is suggested to use the capacitors with low ESR. Using the capacitors with low ESR (as ceramic, OS-CON, tantalum) will have the better transition performance which is with smaller voltage drop when the peak current occurring at the transition. As a general recommendation the output capacitor should be sized above 220μF with the low ESR for SSTL applications with DDR-SDRAM.

Thermal Dissipation

When the current is sinking to or sourcing from V_{TT} , the G2993 will generate internal power dissipation resulting in the heat. Care should be taken to prevent the device from damages caused by the junction temperature exceeding the maximum rating. The maximum allowable internal temperature rise (T_{RMAX}) can be calculated under the given maximum ambient temperature (T_{AMAX}) of the application and the maximum allowable junction temperature (T_{JMAX}).

$$T_{RMAX} = T_{JMAX} - T_{AMAX}$$

From this equation, the maximum power dissipation (P_{DMAX}) of the G2993 can be calculated:

$$P_{DMAX} = T_{RMAX} / \theta_{JA}$$

θ_{JA} of the G2993 will be dependent on several variables: the packages used, the thickness and size of the copper, the number of vias and the airflow. The better θ_{JA} is not only protecting the device well, but also increasing the maximum current capability at the same ambient temperature.

Typical Application Circuits

There are several application circuits shown in Figure 2 through 6 to illustrate some of the possible configurations of the G2993. Figure 2~4 are the SSTL-2 applications. For the majority of applications that imple-

ment the SSTL-2 termination scheme, it is recommended to connect all the input rails to 2.5V rail, as seen in Figure 2. This provides an optimal trade-off between power dissipation and component count.

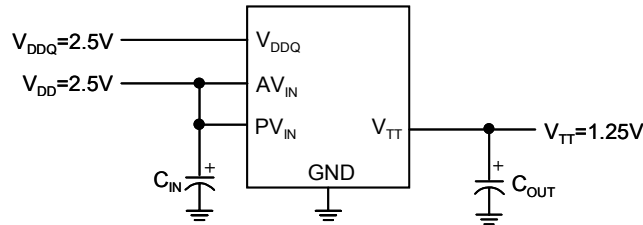

Figure 2. Recommended SSTL-2 Implementation

In Figure 3, the power rails are split. The power rail of the output stage (PVIN) can be as low as 1.8V, the power rail of the analog circuit (AVIN) is operated above 2V. The lower output stage power rail can lower the internal power dissipation when sourcing from the

device and improve the efficiency, but the disadvantage is the maximum continuous current sourcing from V_{TT} is reduced. This configuration is applied when the power dissipation and efficiency are concerned.

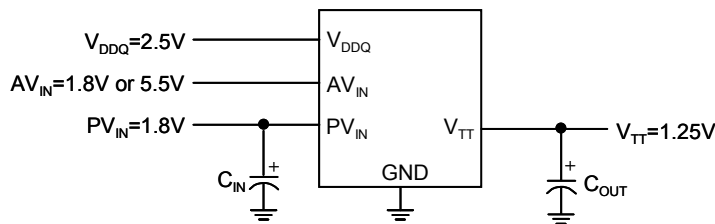

Figure 3. Lower Power Dissipation SSTL-2 Implementation

In Figure 4, the power rail of the output stage (PVIN) is connected to 3.3V to increase the maximum continuous current sourcing from V_{TT} . AVIN should be always equal to or larger than PVIN. This configuration can increase the source capability of this device, but the power dissipation increases at the same time. It

should be more careful to prevent the junction temperature from exceeding the maximum rating. Because of this risk, it is not recommended to supply the output stage power rail (PVIN) with a voltage higher than a nominal 3.3V rail.

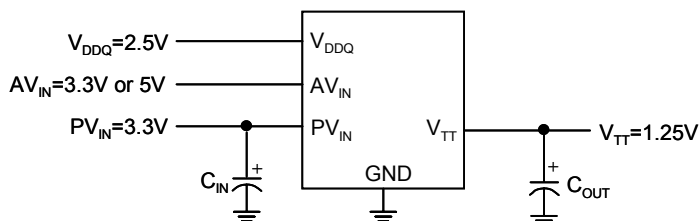

Figure 4. SSTL-2 Implementation with higher voltage rails

In Figure 5 & 6, they are the application configurations of DDR-II SDRAM bus terminations. Figure 5 is the typical application scheme of DDR-II SDRAM. With the separate VDDQ pin and an internal resistor divider,

it is possible to use the G2993 in applications utilizing DDR-II memory. Figure 6 is used to increase the driving capability. The risk is the same as figure 4.

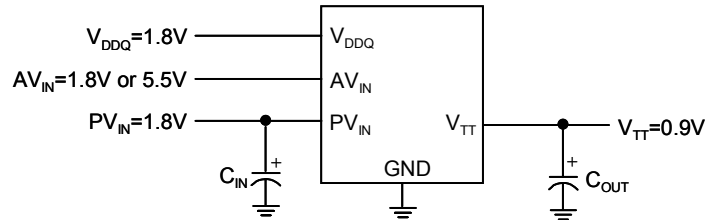

Figure 5. Recommended DDR-II Termination

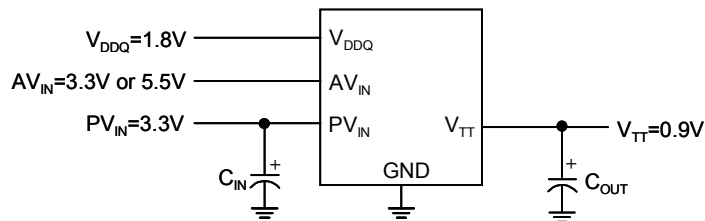
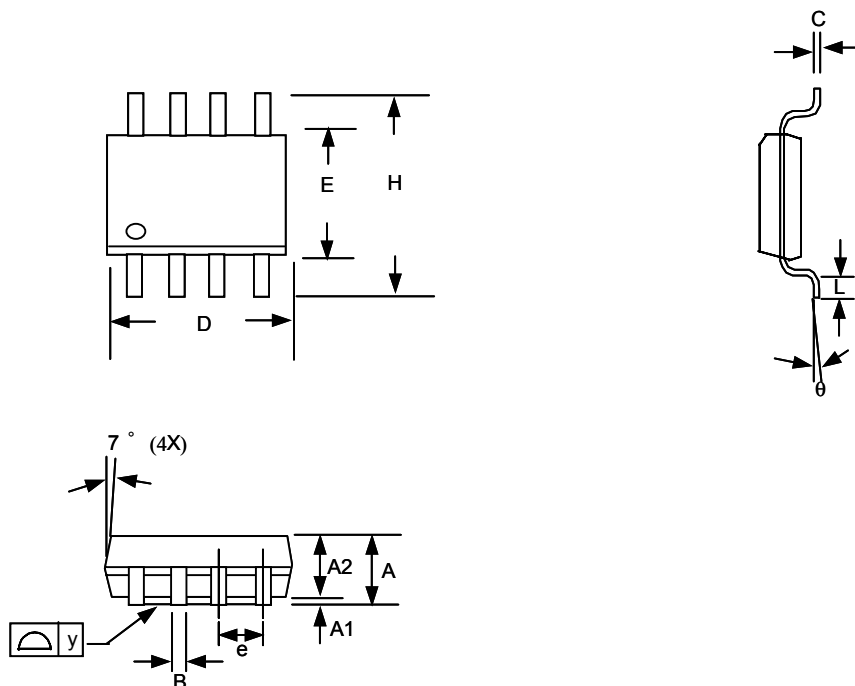

Figure 6. DDR-II Termination with higher voltage rails



Package Information



SOP-8L Package

Note:

1. Package body sizes exclude mold flash and gate burrs
2. Dimension L is measured in gage plane
3. Tolerance 0.10mm unless otherwise specified
4. Controlling dimension is millimeter converted inch dimensions are not necessarily exact.
5. Followed from JEDEC MS-012

SYMBOL	DIMENSION IN MM			DIMENSION IN INCH		
	MIN.	NOM.	MAX.	MIN.	NOM.	MAX.
A	1.35	1.60	1.75	0.053	0.063	0.069
A1	0.10	----	0.25	0.004	----	0.010
A2	----	1.45	----	----	0.057	----
B	0.33	----	0.51	0.013	----	0.020
C	0.19	----	0.25	0.007	----	0.010
D	4.80	----	5.00	0.189	----	0.197
E	3.80	----	4.00	0.150	----	0.157
e	----	1.27	----	----	0.050	----
H	5.80	----	6.20	0.228	----	0.244
L	0.40	----	1.27	0.016	----	0.050
y	----	----	0.10	----	----	0.004
θ	0°	----	8°	0°	----	8°

Taping Specification

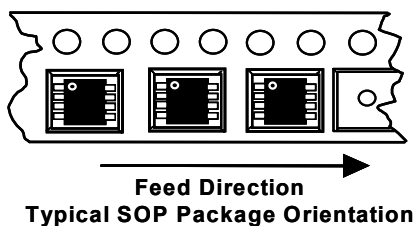

GMT Inc. does not assume any responsibility for use of any circuitry described, no circuit patent licenses are implied and GMT Inc. reserves the right at any time without notice to change said circuitry and specifications.