

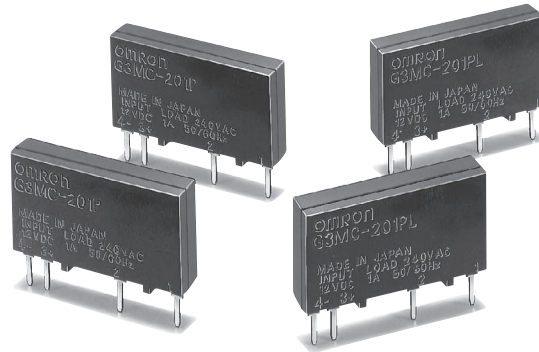

Reinforced Insulation Models Added to Compact, Thin-profile Series of SSRs for PCBs

- 4.5-mm thin design for high-density PCB applications.
- DC input and AC output for applicable load of 1A (at 40°C) and 2A (at 25°C).
- Compact, thin-profile SSR of monoblock construction with an all-in-one lead frame incorporates a PCB, terminals and heat sink



RoHS Compliant



Refer to "Solid State Relays Common Precautions".

Model Number Legend

G3MC-

□	□	□	□	□	□
1	2	3	4	5	

1. Rated Load Power Supply Voltage

- 1: Maximum operating voltage higher than 100 V, lower than 200 V
- 2: Maximum operating voltage higher than 200 V, lower than 300 V

2. Rated Load Current

- 01: 1 A
- 02: 2 A

3. Terminal Type

- P: PCB terminals

4. Zero Cross Function

- Blank: Equipped with zero cross function
- L : Not equipped with zero cross function

5. Certification

- Blank: Certified by UL and CSA (standard models)
- VD : Certified by UL, CSA and EN
- VD-1: Certified by UL, CSA and EN (reinforced insulation models)

List of Models

Isolation	Zero cross function	Indicator	Snubber circuit	Rated output load	Rated input voltage	Model	Minimum packing unit	
Phototriac	Yes	No	Yes	1 A at 100 to 120 VAC	5 VDC	G3MC-101P G3MC-101P-VD	100 pcs	
					12 VDC			
					24 VDC			
	No				5 VDC	G3MC-101PL G3MC-101PL-VD		
					12 VDC			
					24 VDC			
	Yes	No	Yes	1 A at 100 to 240 VAC	5 VDC	G3MC-201P G3MC-201P-VD G3MC-201P-VD-1		
					12 VDC			
					24 VDC			
					No	5 VDC		G3MC-201PL G3MC-201PL-VD G3MC-201PL-VD-1
						12 VDC		
						24 VDC		
Yes	No	Yes	2 A at 100 to 240 VAC	5 VDC	G3MC-202P G3MC-202P-VD G3MC-202P-VD-1			
				12 VDC				
				24 VDC				
				No	5 VDC	G3MC-202PL G3MC-202PL-VD G3MC-202PL-VD-1		
					12 VDC			
					24 VDC			

Note. Refer to the "List of Certified Models" for UL, CSA, and EN approved models.

■ Ratings (at an Ambient Temperature of 25°C)

● Input (Each model has 5-VDC, 12-VDC, and 24-VDC input versions.)

Rated voltage	Operating voltage	Impedance	Must operate voltage level	Must release voltage level
5 VDC	4 to 6 VDC	300Ω ± 20%	4 VDC max.	1 VDC min.
12 VDC	9.6 to 14.4 VDC	800Ω ± 20%	9.6 VDC max.	
24 VDC	19.2 to 28.8 VDC	1.6 kΩ ± 20%	19.2 VDC max.	

● Output

Model	Item	Applicable load			
		Rated load voltage	Load voltage range	Load current	Inrush current
G3MC-101P (-VD) G3MC-101PL (-VD)		100 to 120 VAC 50/60 Hz	75 to 132 VAC 50/60 Hz	0.1 to 1 A *	8 A (60 Hz, 1 cycle)
G3MC-201P (-VD) (-1) G3MC-201PL (-VD) (-1)		100 to 240 VAC 50/60 Hz	75 to 264 VAC 50/60 Hz		
G3MC-202P (-VD) (-1) G3MC-202PL (-VD) (-1)		100 to 240 VAC 50/60 Hz	75 to 264 VAC 50/60 Hz	0.1 to 2 A *	30 A (60 Hz, 1 cycle)

* The load current varies depending on the ambient temperature. Refer to Load Current vs. Ambient Temperature under Engineering Data.

■ Characteristics

Item	Model	G3MC-101P(-VD)	G3MC-101PL(-VD)	G3MC-201P(-VD)(-1) G3MC-202P(-VD)(-1)	G3MC-201PL(-VD)(-1) G3MC-202PL(-VD)(-1)
Operate time		1/2 of load power source cycle + 1 ms max.	1 ms max.	1/2 of load power source cycle + 1 ms max.	1 ms max.
Release time		1/2 of load power source cycle + 1 ms max.			
Output ON voltage drop		1.6 V (RMS) max.			
Leakage current		1 mA max. (at 100 VAC)		1.5 mA max. (at 200 VAC)	
Insulation resistance		1,000 MΩ min. (at 500 VDC)			
Dielectric strength		2,500 VAC, 50/60 Hz for 1 min between input and output (3,000 VAC, 50/60 Hz for 1 min for G3MC-□□□-VD-1)			
Vibration resistance		10 to 55 to 10 Hz, 0.375-mm single amplitude (0.75-mm double amplitude)			
Shock resistance		1,000 m/s ²			
Storage temperature		-30°C to 100°C (with no icing or condensation)			
Ambient operating temperature		-30°C to 80°C (with no icing or condensation)			
Ambient operating humidity		45% to 85%RH			
Weight		Approx. 2.5 g (Approx. 3.8 g for G3MC-202P(L)(-VD)(-1))			

■ Engineering Data

● Load Current vs. Ambient Temperature

G3MC-101P(-VD)

G3MC-101PL(-VD)

G3MC-201P(-VD)(-1)

G3MC-201PL(-VD)(-1)

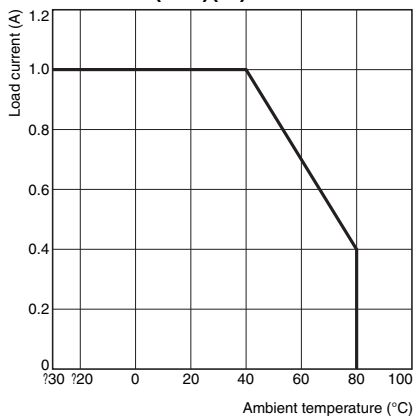

G3MC-202P(-VD)(-1)

G3MC-202PL(-VD)(-1)

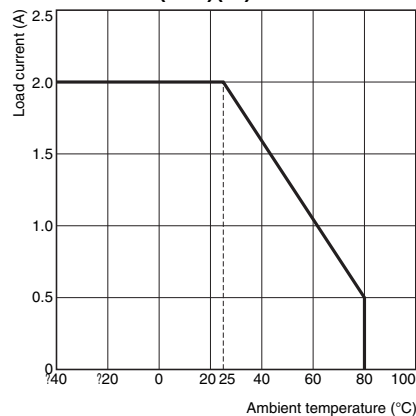

● **One Cycle Surge Current: Non-repetitive** Keep the inrush current to half the rated value if it occurs repeatedly.

**G3MC-101P(-VD)
G3MC-101PL(-VD)
G3MC-201P(-VD)(-1)
G3MC-201PL(-VD)(-1)**

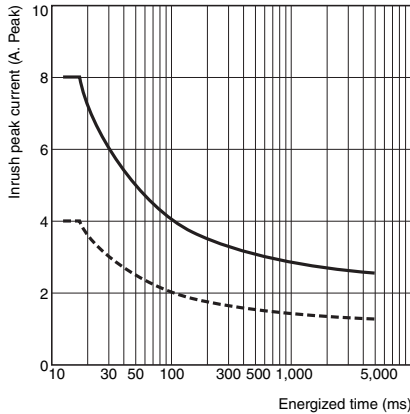

**G3MC-202P(-VD)(-1)
G3MC-202PL(-VD)(-1)**

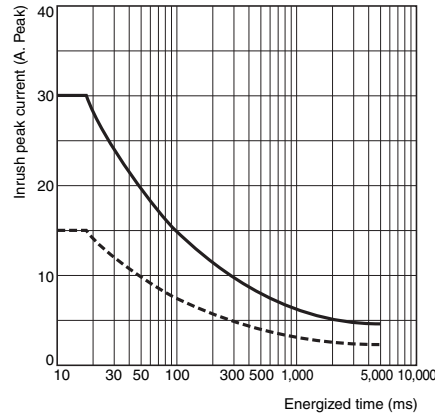

Dimensions

(Unit: mm)

**G3MC-101P(-VD)
G3MC-101PL(-VD)
G3MC-201P(-VD)(-1)
G3MC-201PL(-VD)(-1)**

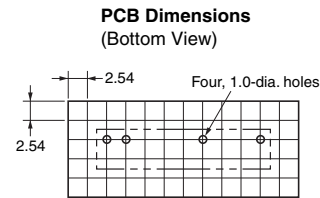
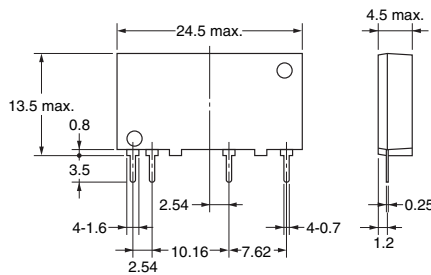
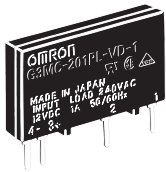

**Terminal Arrangement/
Internal Connections
(Bottom View)**

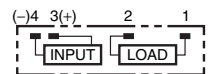

**G3MC-202P(-VD)(-1)
G3MC-202PL(-VD)(-1)**

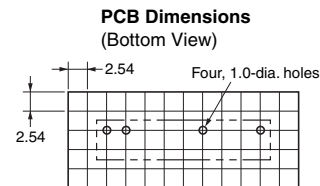
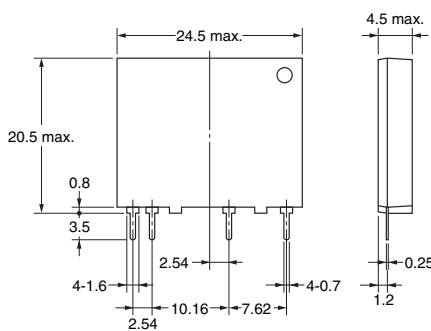
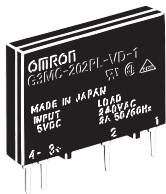

**Terminal Arrangement/
Internal Connections
(Bottom View)**

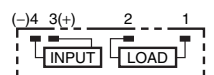

Safety Precautions

● Please refer to “Solid State Relays Common Precautions” for correct use.

Precautions for Correct Use

- The terminals are made of highly heat-conductive materials. Each terminal must be soldered within 10 s at 260°C or within 5 s at 350°C.
- The SSR is of a thin-profile construction. To maintain the vibration resistance of the SSR, make sure that the space between the SSR and PCB is 0.1 mm maximum. Lifting of the PCB can be prevented by setting the hole diameter of the PCBs on both sides slightly smaller than the actual terminal dimension.
- Select the model without the zero-cross function when using the Unit for phase control output.
- The casing works as a heat sink. When mounting two or more Units closely, make sure that the Units are properly ventilated by taking ambient temperature rises into consideration. If Units are closely mounted and used in places with no ventilation, the load current of each Unit must be 1/2 of the rated load current.
- Although LOAD is incorporated with snubber circuit, do not wiring high voltage line and power line together with or in the same duct as the SSR. Doing so may result in malfunction or damage due to induction.
- The input circuit is not incorporated with reverse connection protection circuit. Make sure to check the polarity when wiring.
- Connect the surge absorbers (varistors) in parallel at both ends of the LOAD terminal when applying a surge voltage over 250 V peak for G3MC-10□P(L)(-VD), and over 450V peak for G3MC-20□P(L)(-VD)(-1).

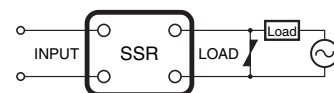

G
3
M
C

• Application examples provided in this document are for reference only. In actual applications, confirm equipment functions and safety before using the product.
• Consult your OMRON representative before using the product under conditions which are not described in the manual or applying the product to nuclear control systems, railroad systems, aviation systems, vehicles, combustion systems, medical equipment, amusement machines, safety equipment, and other systems or equipment that may have a serious influence on lives and property if used improperly. Make sure that the ratings and performance characteristics of the product provide a margin of safety for the system or equipment, and be sure to provide the system or equipment with double safety mechanisms.

Note: Do not use this document to operate the Unit.

OMRON Corporation

ELECTRONIC AND MECHANICAL COMPONENTS COMPANY

Contact: www.omron.com/ecb

Cat. No. J108-E1-04
0812(0207)(O)