

MOS FET Relays

G3VM-353H

Analog-switching MOS FET Relay with SPST-NC (Single-pole, Single-throw, Normally Closed) Contacts

- New models in 350-V load voltage series with SPST-NC contacts and a 6-pin SOP package.
- Continuous load current of 120 mA.
- Dielectric strength of 1,500 Vrms between I/O.

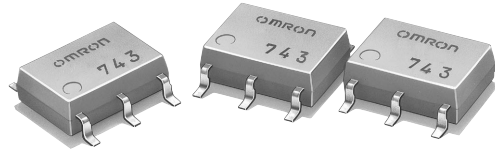

NEW

Application Examples

- Broadband systems
- Measurement devices
- Data loggers
- Amusement machines

Note: The actual product is marked differently from the image shown here.

List of Models

Contact form	Terminals	Load voltage (peak value)	Model	Number per stick	Number per tape
SPST-NC	Surface-mounting terminals	350 VAC	G3VM-353H	75	---
			G3VM-353H(TR)	---	2,500

Dimensions

Note: All units are in millimeters unless otherwise indicated.

G3VM-353H

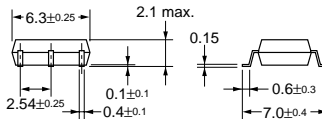
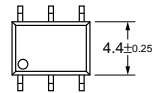
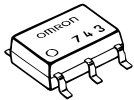

Weight: 0.13 g

Note: The actual product is marked differently from the image shown here.

Terminal Arrangement/Internal Connections (Top View)

G3VM-353H

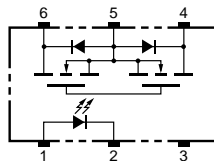

Actual Mounting Pad Dimensions (Recommended Value, Top View)

G3VM-353H

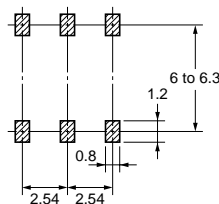

Absolute Maximum Ratings (Ta = 25°C)

Item	Symbol	Rating	Unit	Measurement Conditions		
Input	LED forward current	I_F	50	mA		
	Repetitive peak LED forward current	I_{FP}	1	A	100 μ s pulses, 100 pps	
	LED forward current reduction rate	$\Delta I_F/^\circ\text{C}$	-0.5	mA/°C	Ta \geq 25°C	
	LED reverse voltage	V_R	5	V		
	Connection temperature	T_j	125	°C		
Output	Output dielectric strength	V_{OFF}	350	V		
	Continuous load current	Connection A	I_O	120	mA	
		Connection B		120		
		Connection C		240		
	ON current reduction rate	Connection A	$\Delta I_{ON}/^\circ\text{C}$	-1.2	mA/°C	Ta \geq 25°C
		Connection B		-1.2		
Connection C			-2.4			
Connection temperature	T_j	125	°C			
Dielectric strength between input and output (See note 1.)		V_{I-O}	1,500	Vrms	AC for 1 min	
Operating temperature		T_a	-40 to +85	°C	With no icing or condensation	
Storage temperature		T_{stg}	-55 to +125	°C	With no icing or condensation	
Soldering temperature (10 s)		---	260	°C	10 s	

Note: 1. The dielectric strength between the input and output was checked by applying voltage between all pins as a group on the LED side and all pins as a group on the light-receiving side.

Connection Diagram

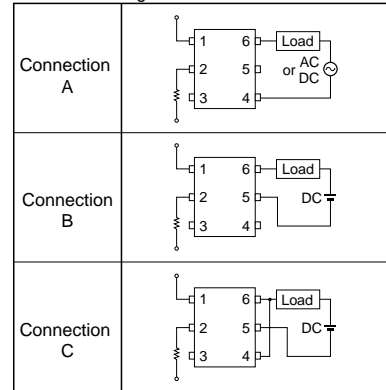

Electrical Characteristics (Ta = 25°C)

Item	Symbol	Minimum	Typical	Maximum	Unit	Measurement conditions		
Input	LED forward voltage	V_F	1.0	1.15	1.3	V	$I_F = 10$ mA	
	Reverse current	I_R	---	---	10	μ A	$V_R = 5$ V	
	Capacity between terminals	C_T	---	30	---	pF	$V = 0$, $f = 1$ MHz	
	Trigger LED forward current	I_{FT}	---	1.0	3.0	mA	$I_{OFF} = 10$ μ A	
Output	Maximum resistance with output ON	Connection A	R_{ON}	---	15	25	Ω	$I_O = 120$ mA
		Connection B		---	8	14	Ω	$I_O = 120$ mA
		Connection C		---	4	---	Ω	$I_O = 240$ mA
	Current leakage when the relay is open	I_{LEAK}	---	---	1.0	μ A	$V_{OFF} = 350$ V, $I_F = 5$ mA	
Capacity between I/O terminals		C_{I-O}	---	0.8	---	pF	$f = 1$ MHz, $V_s = 0$ V	
Insulation resistance		R_{I-O}	1,000	---	---	M Ω	$V_{I-O} = 500$ VDC, $RoH \leq 60\%$	
Turn-ON time		t_{ON}	---	---	1.0	ms	$I_F = 5$ mA, $R_L = 200$ Ω , $V_{DD} = 20$ V (See note 2.)	
Turn-OFF time		t_{OFF}	---	---	3.0	ms		

Note: 2. Turn-ON and Turn-OFF Times

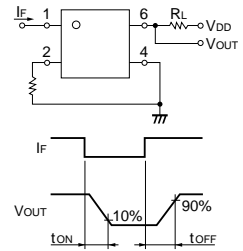

Recommended Operating Conditions

Use the G3VM under the following conditions so that the Relay will operate properly.

Item	Symbol	Minimum	Typical	Maximum	Unit
Output dielectric strength	V_{DD}	---	---	280	V
Operating LED forward current	I_F	5	---	25	mA
Continuous load current	I_O	---	---	120	mA
Operating temperature	T_a	-20	---	65	°C

Engineering Data

Load Current vs. Ambient Temperature

G3VM-353H

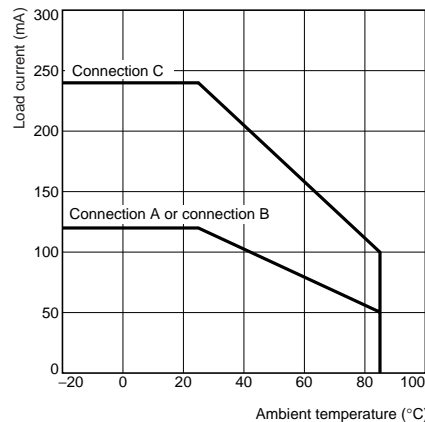

Safety Precautions

Refer to page 6 for precautions common to all G3VM models.