

1MHz 1A Synchronous Step-Down Regulator

Features

- High Efficiency: Up to 93%
- Low Quiescent Current: Only 50µA During Operation
- Internal Soft Start Function
- 1A Output Current
- 2.5V to 6V Input Voltage Range
- 1MHz Switching Frequency
- No Schottky Diode Required
- 100% Duty Cycle in Dropout Operation
- 0.6V Reference Allows Low Output Voltages
- <1µA Shutdown Current
- Current Mode Operation for Excellent Line and Load Transient Response
- Over Temperature Protected
- RoHS Compliant

General Description

The G5728 is a high efficiency monolithic synchronous buck regulator using a constant frequency, current mode architecture. Supply current during operation is only 50µA and drops to <1µA in shutdown. The 2.5V to 6V input voltage range makes the G5728 ideally suited for single Li-Ion battery-powered applications. 100% duty cycle provides low dropout operation, extending battery run time in portable systems. Switching frequency is internally set at 1MHz, allowing the use of small surface mount inductors and capacitors. The internal synchronous switch increase efficiency and eliminates the need for an external Schottky diode. Built-in soft start function eliminates in-rush current that could damage the system.

Applications

- Cellular Telephones
- Personal Information Appliances
- Microprocessors and DSP Core Supplies
- Wireless and DSL Modems
- Digital Still and Video Cameras
- MP3 Players
- Portable Instruments

Ordering Information

ORDER NUMBER	MARKING	OUTPUT VOLTAGE	TEMP. RANGE	PACKAGE (Green)
G5728TO1U	5728x	Adjustable	-40°C~ +85°C	TSOT-23-5

Note: TO:TSOT-23-5
1: Bonding Code
U: Tape & Reel

Pin Configuration

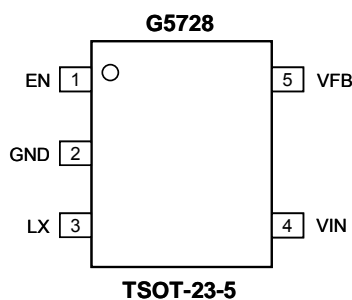

Typical Application Circuit

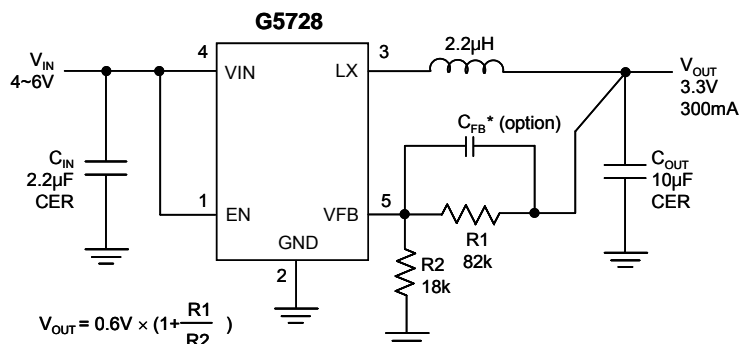

Absolute Maximum Ratings

VIN to GND	-0.3V to +7V
EN, VFB to GND	-0.3V to (VIN + 0.3V)
LX to GND	-0.3V to (VIN + 0.3V)
LX to GND	-3V to (VIN + 3V) for <20ns
P-Channel Switch Source Current (DC)	1.2A
N-Channel Switch Sink Current (DC)	1.2A
Peak LX Sink and Source Current	2.5A
Thermal Resistance Junction to Ambient, (θ_{JA})*	
TSOT-23-5	240°C/W

Continuous Power Dissipation ($T_A = +25^\circ\text{C}$)*	
TSOT-23-5	520mW
Thermal Resistance Junction to Case, (θ_{JC})	
TSOT-23-5	60°C/W
Operating Temperature Range	-40°C to 85°C
Maximum Junction Temperature	150°C
Storage Temperature Range	-65°C to 165°C
Reflow Temperature (soldeing, 10 sec)	260°C

* Please Refer to Minimum Footprint PCB Layout Section.

Electrical Characteristics

$T_A = 25^\circ\text{C}$, $V_{IN} = 3.6\text{V}$.

The device is not guaranteed to function outside its operating conditions. Parameters with MIN and/or MAX limits are 100% tested at +25°C, unless otherwise specified.

PARAMETER	CONDITION	MIN	TYP	MAX	UNIT
Feedback Current		-30	0	+30	nA
Regulated Feedback Voltage		588	600	612	mV
Reference Voltage Line Regulation	$V_{IN} = 2.5\text{V to } 5.5\text{V}$	---	0.1	---	%/V
Peak Inductor Current	$V_{IN} = 5\text{V}, V_{OUT} = 3\text{V}$	1.2	1.5	---	A
Output Voltage Load Regulation		---	0.5	---	%
Input Voltage Range		2.5	---	6	V
Undervoltage Lockout Threshold (UVLO)		---	2.2	---	V
UVLO hysteresis		---	0.1	---	V
Quiescent Current	Active Mode (no switching)	---	50	150	μA
	Shutdown Mode	---	0	1	
Oscillator Frequency		---	1.0	---	MHz
$R_{DS(ON)}$ of P-Channel FET	$I_{LX} = 100\text{mA}$	---	0.3	0.5	Ω
$R_{DS(ON)}$ of N-Channel FET	$I_{LX} = 100\text{mA}$	---	0.3	0.5	Ω
LX Leakage Current	$EN = 0\text{V}, V_{LX} = 5\text{V}, V_{IN} = 5\text{V}$	---	---	1	μA
EN Threshold	Logic High	2	---	---	V
	Logic Low	---	---	0.4	
EN Leakage Current		---	0	1	μA
Maximum Duty Cycle		100	---	---	%
Minimum On Time		---	---	0	ns

Typical Performance Characteristics

$C_{VIN}=2.2\mu F$, $C_{VOUT}=10\mu F$, $L=2.2\mu H$, $T_A=25^\circ C$, unless otherwise noted.

Start-Up from Shutdown

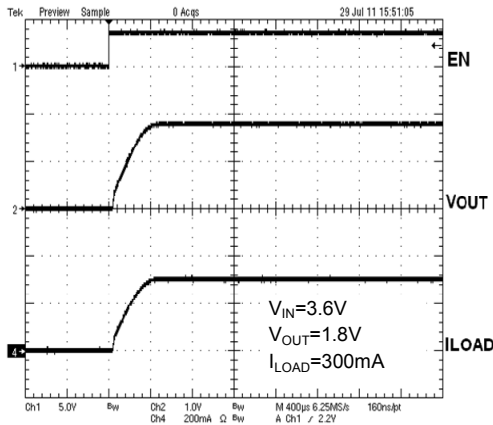

Line Transient Response

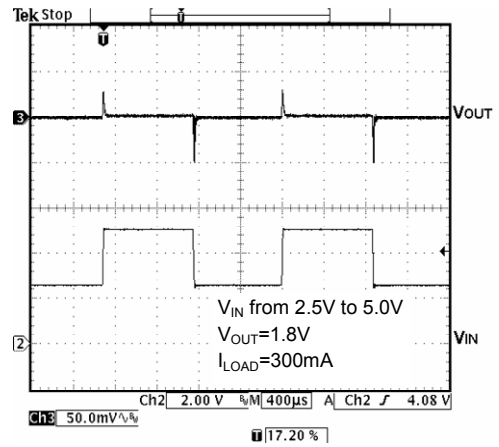

Load Transient Response

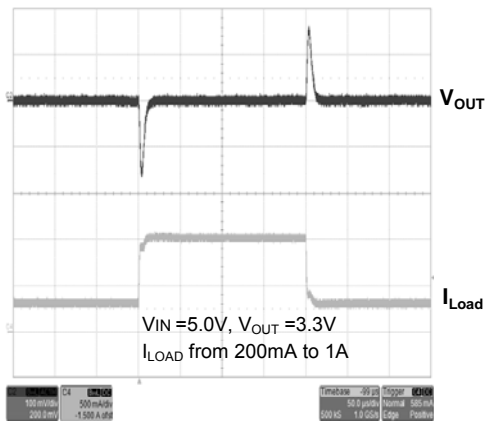

Load Transient Response

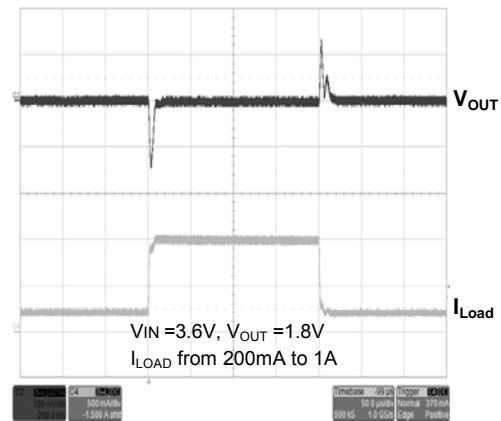

Output Voltage vs Load Current

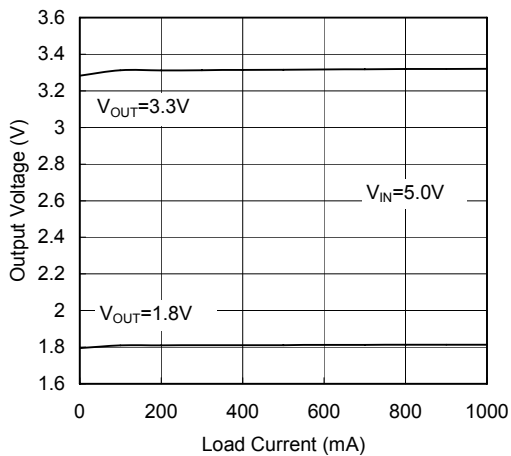

Efficiency vs Output Current

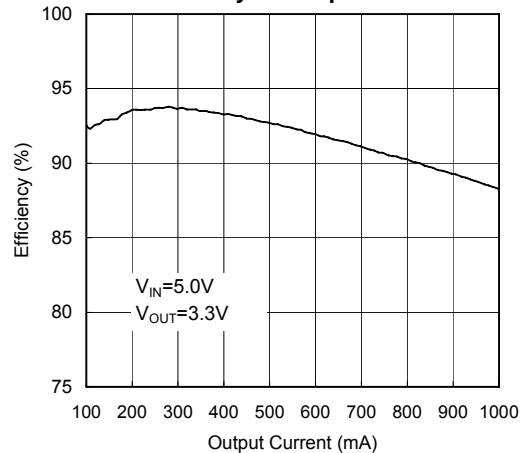

Typical Performance Characteristics (continued)

Supply Current vs Supply Voltage

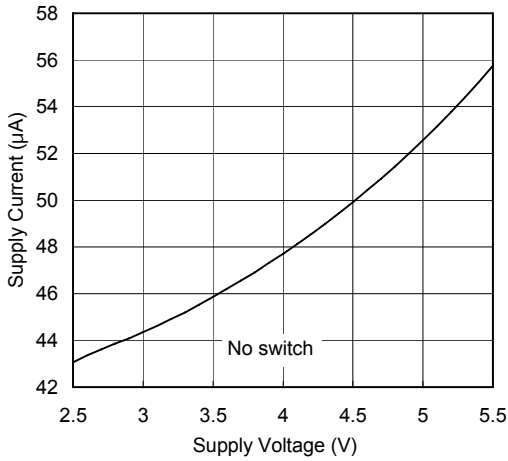

Supply Current vs Temperature

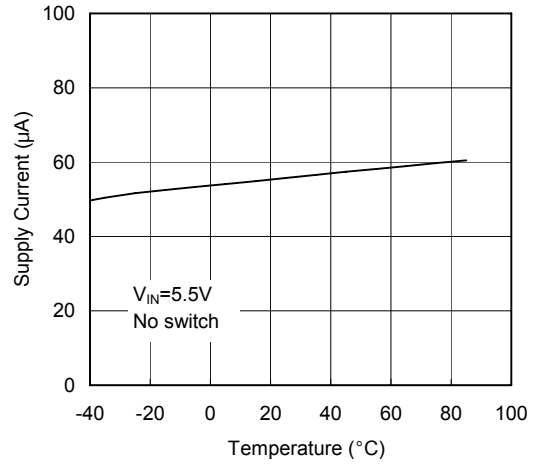

Shutdown Supply Current vs Supply Voltage

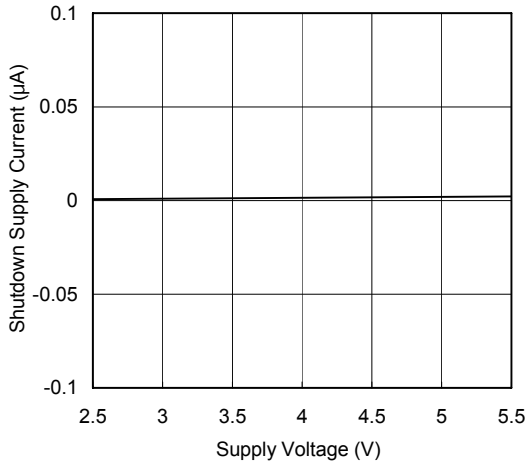

Oscillator Frequency vs Supply Voltage

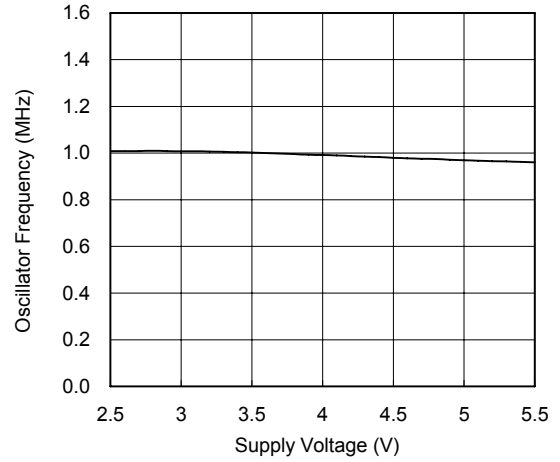

Enable Input Threshold vs Supply Voltage

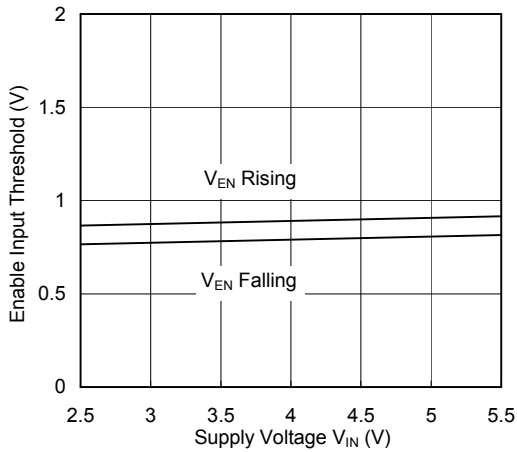

Enable Input Threshold vs Temperature

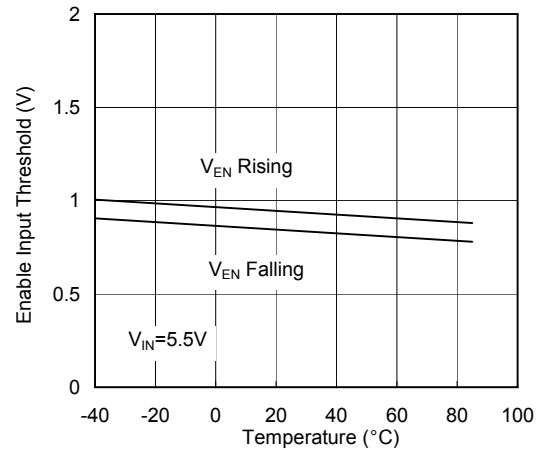

Typical Performance Characteristics (continued)

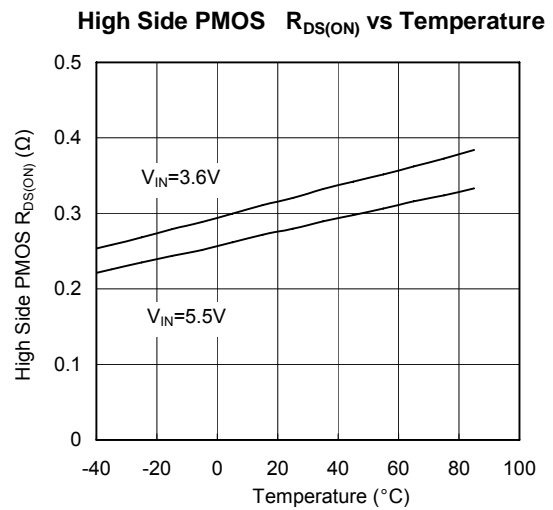
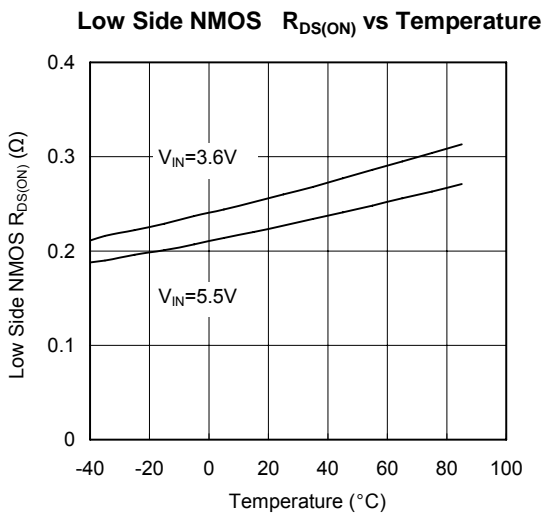
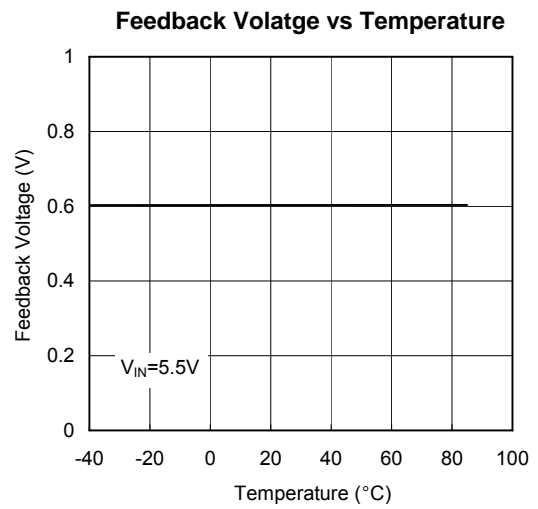
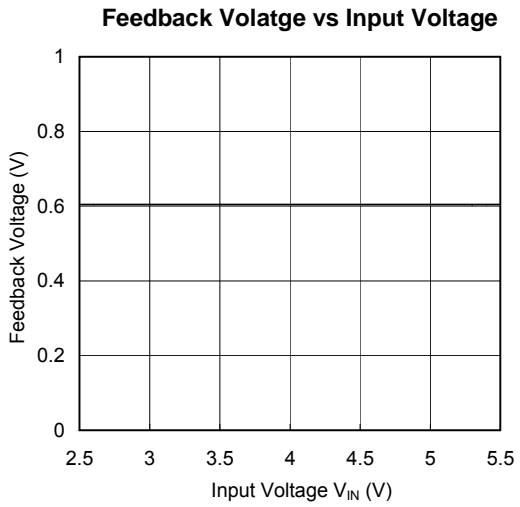

Minimum Footprint PCB Layout Section

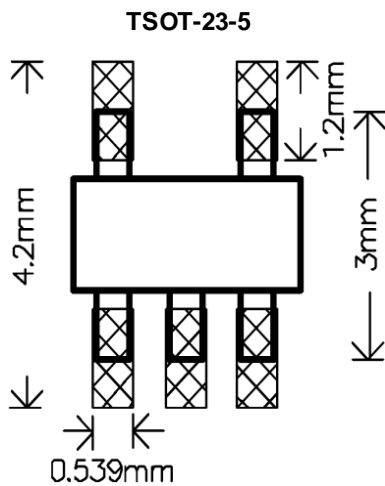

Pin Descriptions

PIN	NAME	FUNCTION
1	EN	Enable Control Pin (Active high, do not leave EN pin floating)
2	GND	Ground Pin
3	LX	Switch Pin
4	VIN	Input Supply Pin
5	VFB	Feedback Pin

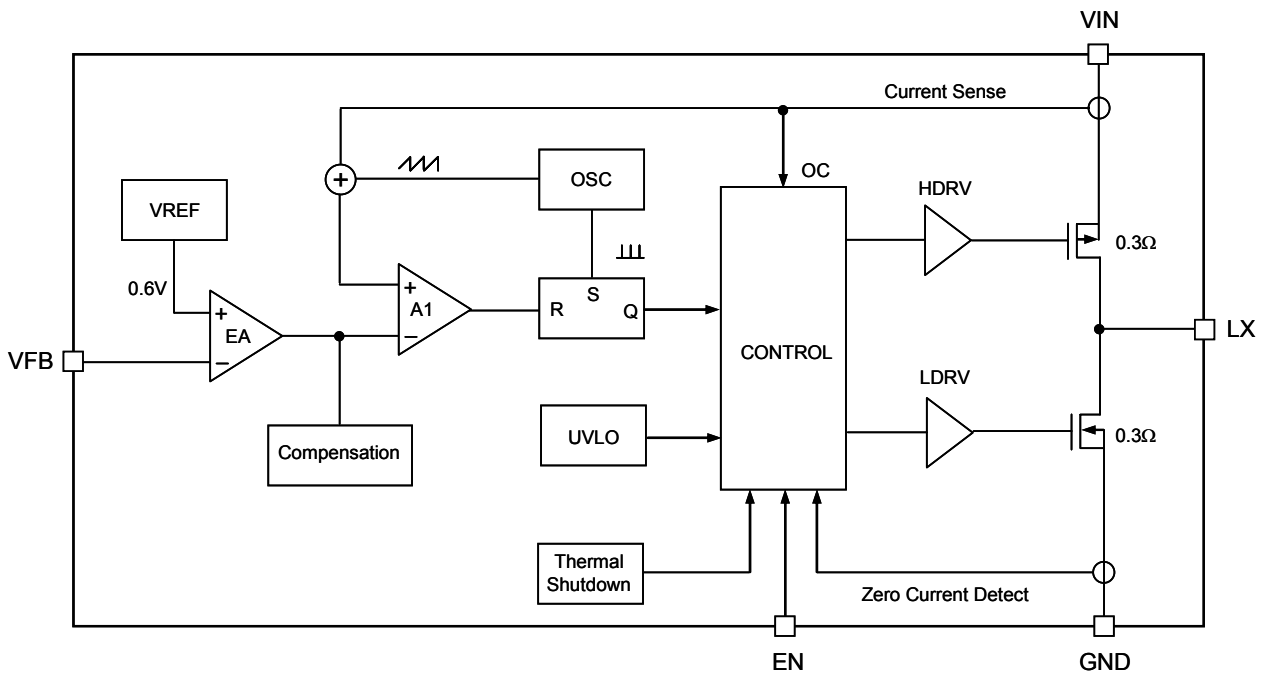
Block Diagram

Function Description

Normal Operation

The G5728 uses a constant frequency, current mode step-down architecture. Both the high/low-side switches are internal. During normal operation, the internal high-side (PMOS) switch is turned on each cycle when the oscillator sets the SR latch, and turned off when the comparator (A1) resets the SR latch. The peak inductor current at which comparator (A1) resets the SR latch, is controlled by the output of error amplifier EA. While the high-side switch is off, the low-side switch is turned on until either the inductor current starts to reverse or the beginning of the next switching cycle.

Dropout Operation

As the input supply voltage decreases to a value approaching the output voltage, the duty cycle increases toward the maximum on-time. Further reduction of the supply voltage forces the high-side switch to remain on for more than one cycle until it reaches 100% duty cycle. The output voltage is dropped from the input supply for the voltage which across the high-side switch.

Over Temperature Protection

In most applications the G5728 does not dissipate much heat due to high efficiency. But, in applications where the G5728 is running at high ambient temperature with low supply voltage and high duty cycles, such as in dropout, the heat dissipated may exceed the maximum junction temperature of the part. If the junction temperature reaches approximately 150°C, both power switches will be turned off and the SW node will become high impedance.

Soft-Start

The G5728 employs soft-start circuitry to reduce supply inrush current during startup conditions. When the device exits under-voltage lockout or shut-down mode, the soft-start circuitry will slowly ramp up the output voltage.

Over Current Protection

The G5728 cycle-by-cycle limits the peak inductor current to protect embedded switch from damage. Hence the maximum output current (the average of inductor current) is also limited. In case the load increases, the inductor current is also increase. Whenever the current limit level is reached, the output voltage can not be regulated and starting to drop.

Short-circuit Protection

Short-circuit protection will activate once the feedback voltage falls below 0.3V, and the operating frequency is switched to 250kHz to reduce power delivered from input to output.

Application Information

Inductor Selection

For most applications, the value of the inductor will fall in the range of 2.2μH to 10μH. Its value is chosen based on the desired ripple current. Large value inductors lower ripple current and small value inductors result in higher ripple currents. Higher V_{IN} or V_{OUT} also increase the ripple current ΔI_L :

$$\Delta I_L = \frac{1}{fL} V_{OUT} \left(1 - \frac{V_{OUT}}{V_{IN}} \right)$$

where f =switching frequency, L =inductance. A reasonable inductor current ripple is usually set as 1/2 to 1/5 of maximum out current.

The DC current rating of the inductor should be at least equal to the maximum load current plus half the ripple current to prevent core saturation. For better efficiency, choose a low DCR inductor.

Capacitor Selection

In continuous mode, the source current of the top MOSFET is a square wave of duty cycle V_{OUT}/V_{IN} . To prevent large voltage transients, a low ESR input capacitor sized for maximum RMS current must be used. The maximum RMS capacitor current is given by:

$$C_{IN} \text{ requires } I_{RMS} \cong I_{OMAX} \frac{\sqrt{V_{OUT}(V_{IN} - V_{OUT})}}{V_{IN}}$$

This formula has a maximum at $V_{IN}=2V_{OUT}$, where $I_{RMS}=I_{OUT}/2$. This simple worst case condition is commonly used for design because even significant deviations do not offer much relief.

The selection of C_{OUT} is driven by the required effective series resistance (ESR). Typically, once the ESR requirement for C_{OUT} has been met, the RMS current rating generally far exceeds the $I_{RIPPLE(P-P)}$ requirement. The output ripple ΔV_{OUT} is determined by:

$$\Delta V_{OUT} \cong \Delta I_L \left(ESR + \frac{1}{8fC_{OUT}} \right)$$

For a fixed output voltage, the output ripple is highest at maximum input voltage since ΔI_L increases with input voltage.

Nowadays, higher value, lower cost ceramic capacitors are becoming available in smaller case sizes. Their high ripple current, high voltage rating and low ESR make them ideal for switching regulator applications. Because the G5728's control loop does not depend on the output capacitor's ESR for stable opera-

tion, ceramic capacitors can be used freely to achieve very low output ripple and small circuit size.

When choosing the input and output ceramic capacitors, choose the X5R or X7R dielectric formulations. These dielectrics have the best temperature and voltage characteristics of all the ceramics for given value and size.

Output Voltage Programming

In the adjustable version of G5728, the output voltage is set by a resistive divider according to the following formula:

$$V_{OUT} = 0.6 \times \left(1 + \frac{R1}{R2} \right) \text{ Volt.}$$

Efficiency Considerations

Although all dissipative elements in the circuit produce losses, one major source usually account for most of the losses in G5728 circuits: I^2R losses. The I^2R loss dominates the efficiency loss at medium to high load currents.

The I^2R losses are calculated from the resistances of the internal switches, R_{SW} , and external inductor R_L . In continuous mode, the average output current flowing through inductor L is "chopped" between the main switch and the synchronous switch. Thus the series resistance looking into the LX pin is a function of both top and bottom MOSFET $R_{DS(ON)}$ and the duty cycle (D) as follows:

$$R_{SW} = (R_{DS(ON)TOP})(D) + (R_{DS(ON)BOTTOM})(1-D)$$

The $R_{DS(ON)}$ for both the top and bottom MOSFETs can be obtained from Electrical Characteristics table. Thus,

to obtain I^2R losses, simply add R_{SW} to R_L and multiply the result by the square of the average output current.

Other losses including C_{IN} and C_{OUT} ESR dissipative losses and inductor core losses generally account for less than 2% total additional loss.

Checking Transient Response

The regulator loop response can be checked by looking at the load transient response. Switching regulators take several cycles to respond to a step in load current. When a load step occurs, V_{OUT} immediately shifts by an amount equal to $(\Delta I_{LOAD} \times ESR)$, where ESR is the effective series resistance of C_{OUT} . ΔI_{LOAD} also begins to charge or discharge C_{OUT} , which generates a feedback error signal. The regulator loop then acts to return V_{OUT} to its steady-state value. During this recovery time V_{OUT} can be monitored for overshoot or ringing that would indicate a stability problem.

Thermal considerations

In most application the G5728 does not dissipate much heat due to its high efficiency. But, in applications where the G5728 is running at high ambient temperature with low supply voltage and high duty cycles, such as in dropout, the heat dissipated may exceed the maximum junction temperature of the part. If the junction temperature reaches approximately 150°C, both power switches will be turned off and the LX node will become high impedance.

Assume power dissipation on G5728 $P_D=0.1W$, ambient temperature $T_A=70^\circ C$, thermal resistance of junction to ambient $R_{JA}=240^\circ C/W$, then temperature junction $T_J = T_A + R_{JA} * P_D = 94^\circ C$.

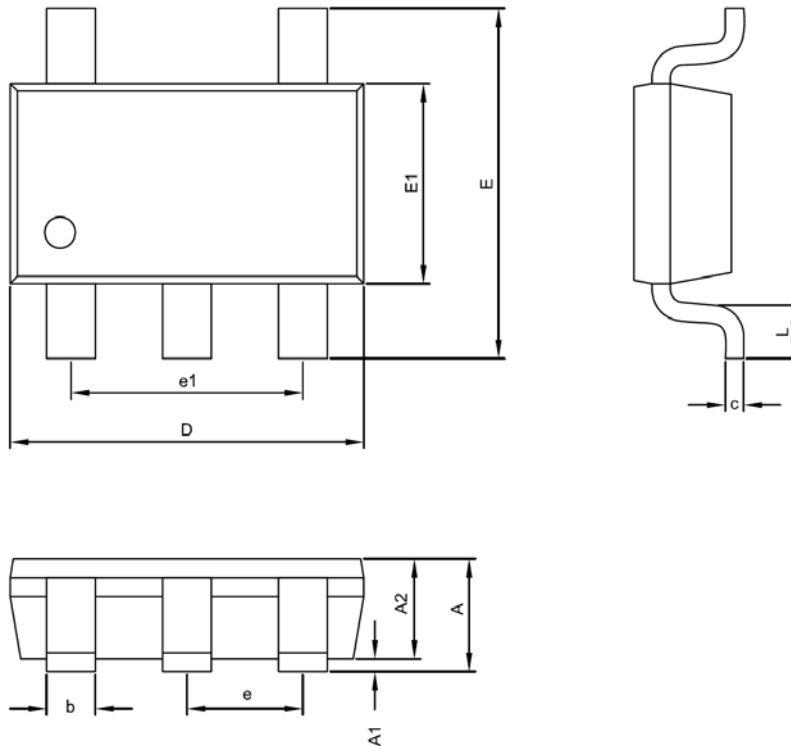
Package Information

TSOT-23-5 Package

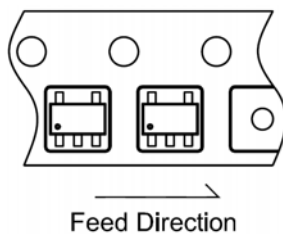
Symble	DIMENSION IN MM			DIMENSION IN INCH		
	MIN.	NOM.	MAX.	MIN.	NOM.	MAX.
A	---	---	1.00	---	---	0.039
A1	0.00	0.05	0.10	0.000	0.002	0.004
A2	0.70	0.80	0.90	0.028	0.031	0.035
D	2.70	2.90	3.10	0.106	0.114	0.122
E	2.60	2.80	3.00	0.102	0.110	0.118
E1	1.50	1.60	1.70	0.059	0.063	0.067
c	0.08	0.15	0.25	0.003	0.006	0.010
b	0.30	0.40	0.50	0.012	0.016	0.020
e	0.95 BSC			0.037 BSC		
e1	1.90 BSC			0.075 BSC		
L	0.30	0.45	0.60	0.012	0.018	0.024

Taping Specification

PACKAGE	Q'TY/REEL
TSOT-23-5	3,000 ea

GMT Inc. does not assume any responsibility for use of any circuitry described, no circuit patent licenses are implied and GMT Inc. reserves the right at any time without notice to change said circuitry and specifications.