

Ultra Low-Dropout, Constant-Current White LED Bias

Features

- Ultra Low 150mV Dropout at 20mA
- 0.6% High Accuracy Current Matching
- 20mA Full Scale Current
- 32 Level Linear Current Brightness Control
- PWM Brightness Control
- 2.5V to 5.5V Supply Voltage Range
- SOT-23-6 Package (G5920)
- MSOP-8 Package (G5921)

Applications

- Mobile Phones
- White LED backlighting

General Description

The G5920/G5921 is a high performance ultra low-dropout constant current bias supply for white LEDs. It can be used as an alternative to the simple ballast resistors in conventional parallel white LEDs applications. Each white LED bias current is matching to 0.6%.

For dimming control, an enable input pin is controlled by processor GPIO output pulses for 32 level linear current. Using a low frequency PWM waveform to this enable input pin also controls the average LED current which is proportional to the PWM duty.

The G5920/G5921 is suitable for single cell Li-ion battery power device that using low forward voltage white LEDs. The white LEDs can be powered directly from battery without extra external components. This takes an advantage of highest efficiency and creates no EMI problem.

Ordering Information

ORDER NUMBER	ORDER NUMBER (Pb free)	MARKING	TEMP. RANGE	PACKAGE
G5920TB1U	G5920TB1Uf	5920x	-40°C to 85°C	SOT-23-6
G5921P8U	G5921P8Uf	5921x	-40°C to 85°C	MSOP-8

Note:TB : SOT23-6
P8: MSOP-8
U: Tape & Reel

Pin Configuration

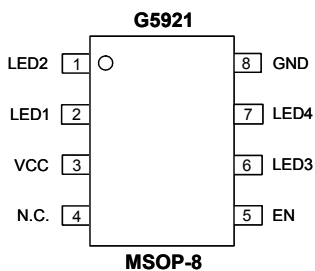
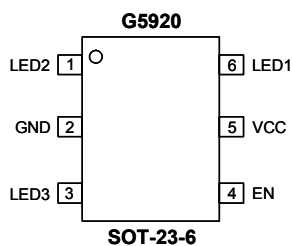

Typical Application Circuit

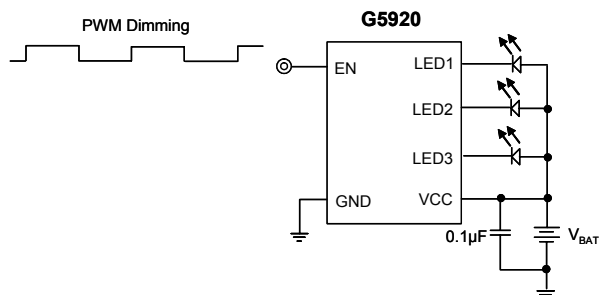
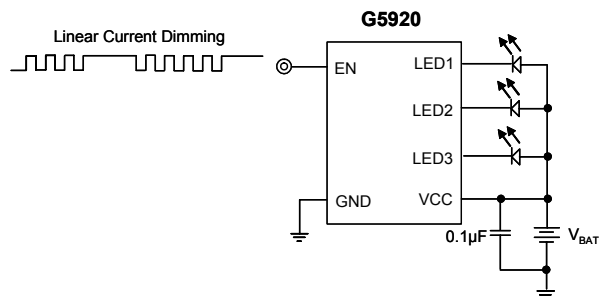

**Absolute Maximum Ratings**

VCC to GND.....-0.3V to +7.0V
 EN, LED1, LED2, LED3 to GND.....-0.3V to VCC+0.3V
 Operating Temperature Range.....-40 to 85°C

Junction Temperature.....125°C
 Storage Temperature.....-65°C to 150°C
 Reflow Temperature (soldering, 10sec).....260°C

Stress beyond those listed under "Absolute Maximum Rating" may cause permanent damage to the device.

Electrical Characteristics

$V_{CC} = V_{EN} = 3.6V$, $T_A = 25^\circ C$

PARAMETER	CONDITION	MIN	TYP	MAX	UNIT
Input Voltage Range	V_{CC}	2.5	---	5.5	V
Quiescent Current	I_Q	---	180	230	μA
Shutdown Current	$I_{Q(OFF)}$, $V_{EN} = 0V$	-1	---	+1	μA
Input Voltage UVLO Threshold	V_{UVLO}	---	2	---	V
Output Current	Max I_{LED}	18	20	22	mA
Output Current Line Regulation	$V_{LED} = 0.5V \sim 2V$	-0.5	---	+0.5	%/V
Current Matching	$V_{LED} = 0.5V$	-4	± 0.6	+4	%
LED Pin Voltage Dropout	$V_{LED(DROP)}$, 90% Max I_{LED}	---	---	0.15	V
EN Pin Input Voltage High	V_{IH}	2	---	---	V
EN Pin Input Voltage Low	V_{IL}	---	---	0.8	V
EN Pin Input Current	I_{EN}	-1	---	+1	μA
EN Pin Off Timeout	T_{OFF}	40	80	200	μS
EN Pin End of Pulse Timeout	T_{EOP}	40	80	200	μS
EN Pin Pulse High Time	T_{HIGH}	5	---	30	μS
EN Pin Pulse Low Time	T_{LOW}	5	---	30	μS



Typical Performance Characteristics

$V_{CC}=V_{EN}=3.6V$, $V_{LED}=0.5V$, $T=25^{\circ}C$, unless otherwise noted.

PWM Diming Waveform

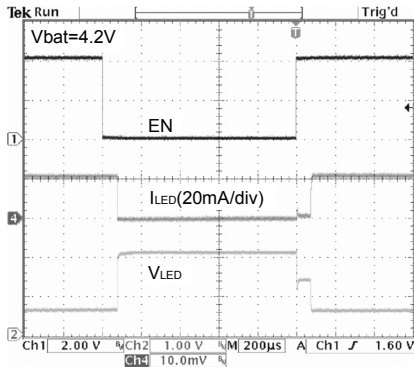

Linear Dimming Waveform I

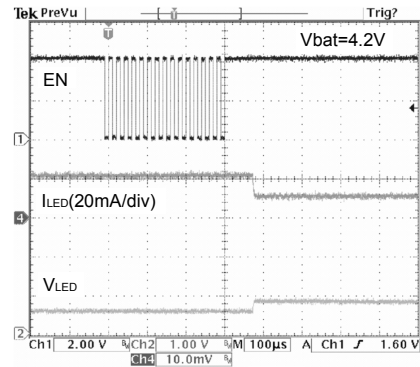

Linear Dimming Waveform II

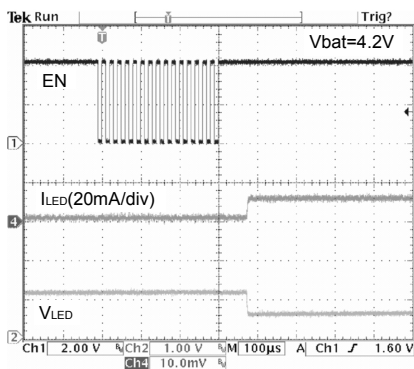

Input Voltage UVLO

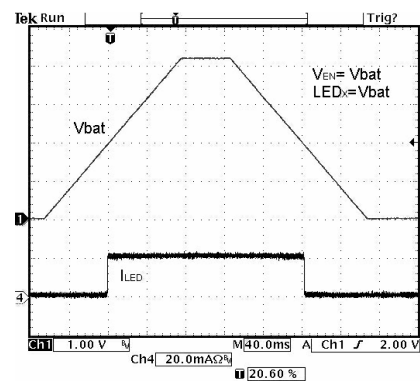

Quiescent Current vs. Temperature

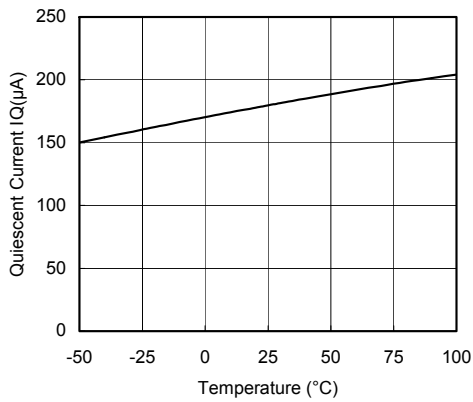

Quiescent Current vs. VCC

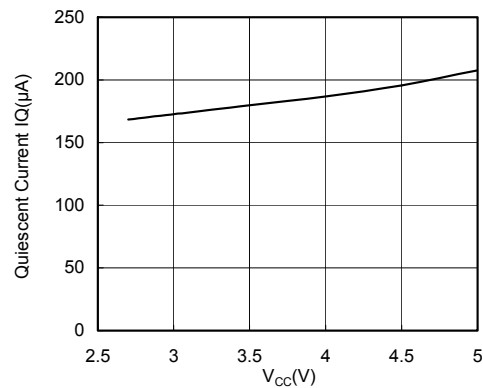



Typical Performance Characteristics (continued)

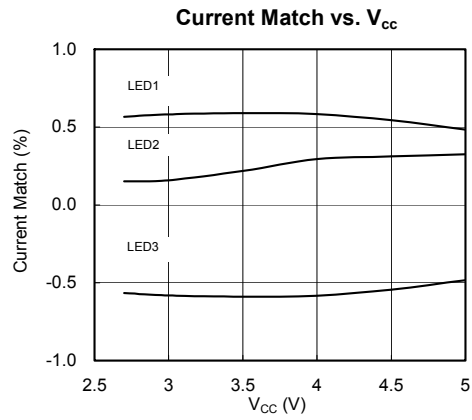
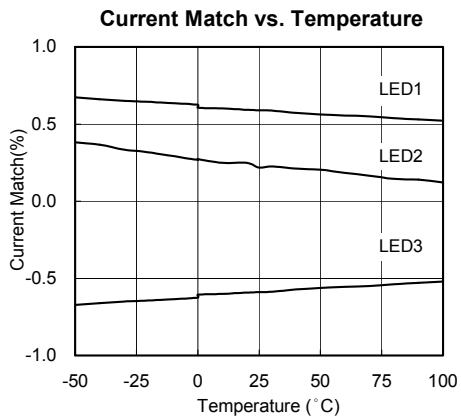
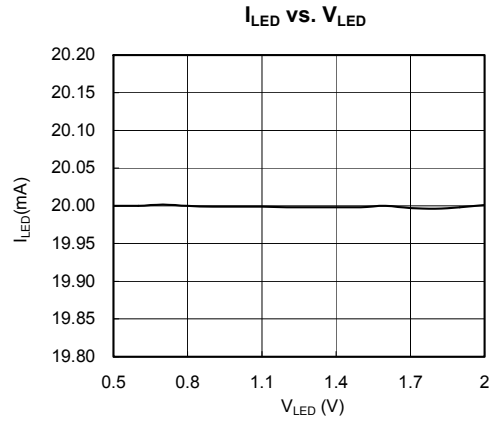
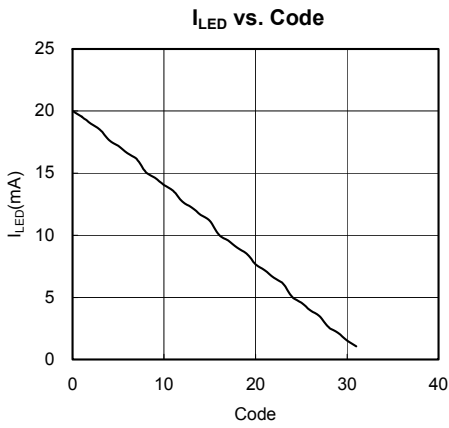
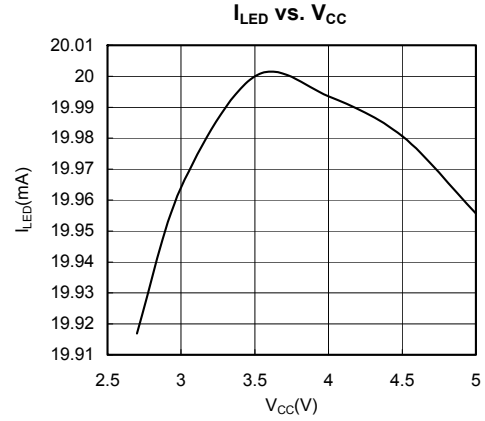
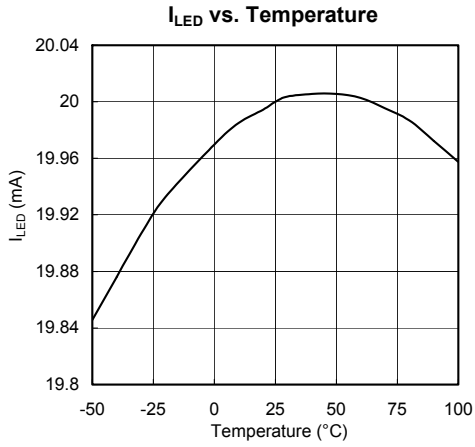

Typical Performance Characteristics (continued)

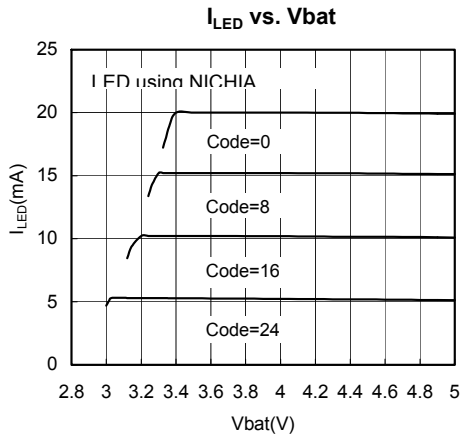
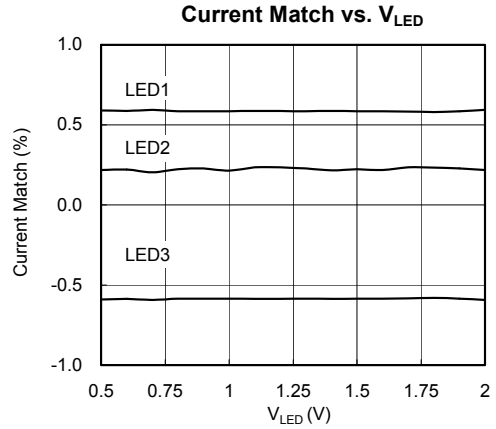
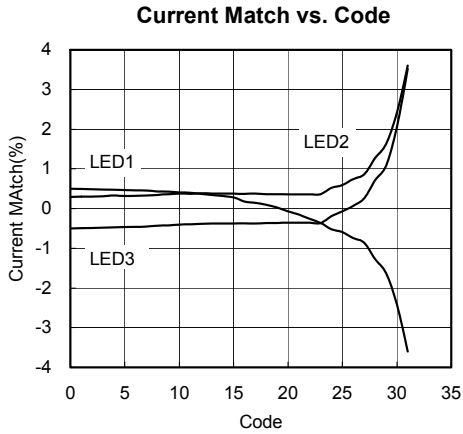

Recommend Minimum Footprint

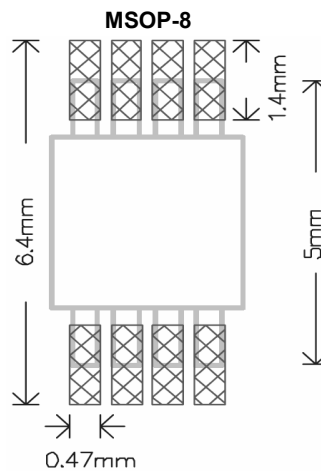
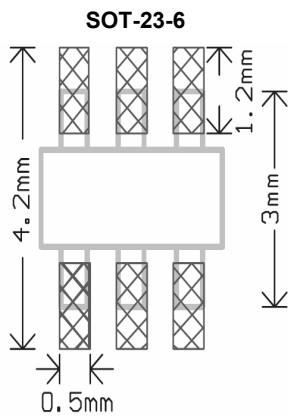



Pin Descriptions

PIN		NAME	FUNCTION
G5920	G5921		
SOT-23-6	MSOP-8		
1	1	LED2	LED2 bias current input.
2	8	GND	Ground.
3	6	LED3	LED3 bias current input.
4	5	EN	Enable Dimming control.
5	3	VCC	Power supply.
6	2	LED1	LED1 bias current input.
	7	LED4	LED4 bias current input.
	4	N.C.	Not Connected.

Block Diagram

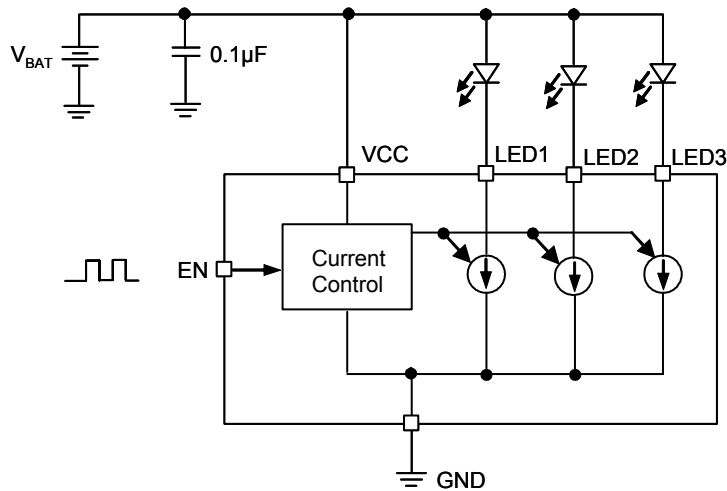

Function Description

G5920/G5921 LED pins act as well matched current source driving LED diode to ground. An EN pin is used to turn on and turn off G5920/G5921.

When applying a lower frequency (less than 2kHz) PWM waveform to EN pin, the average LED current will be duty*20mA(typical). Refer to Fig.1

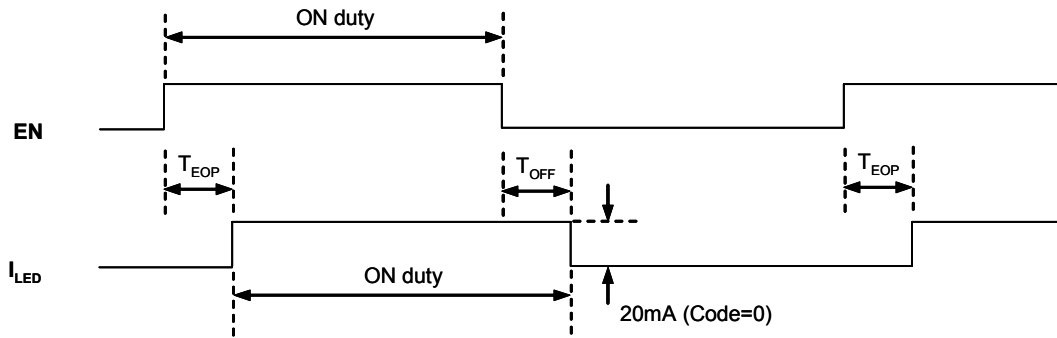

Fig.1 Turn ON to PWM dimming

If the application is not suitable to apply such a low frequency PWM dimming waveform, this EN pin can be negatively pulsed to set continuous LED current. When no negative pulse is input to EN pin (Code=0), the internal register will be latched to set the maximum

LED current, typically 20mA. Whenever input N negative pulses to the EN pin, it will get a LED current corresponding to Code N. In this manner, LED current will change from previous value to new value after the last pulse for typical 80μs (T_{EOP}). Please refer to Fig.2

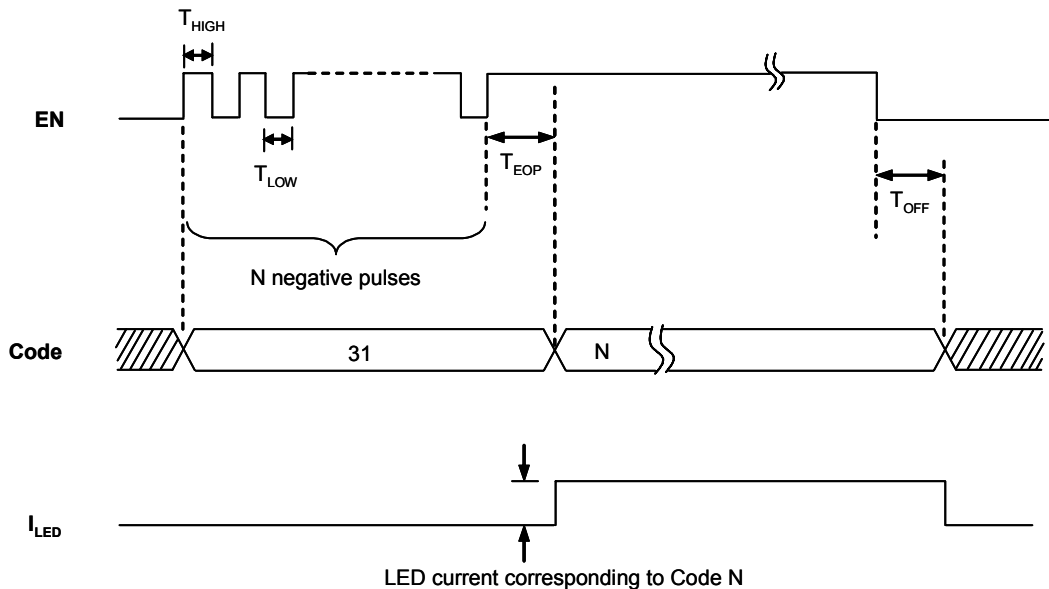
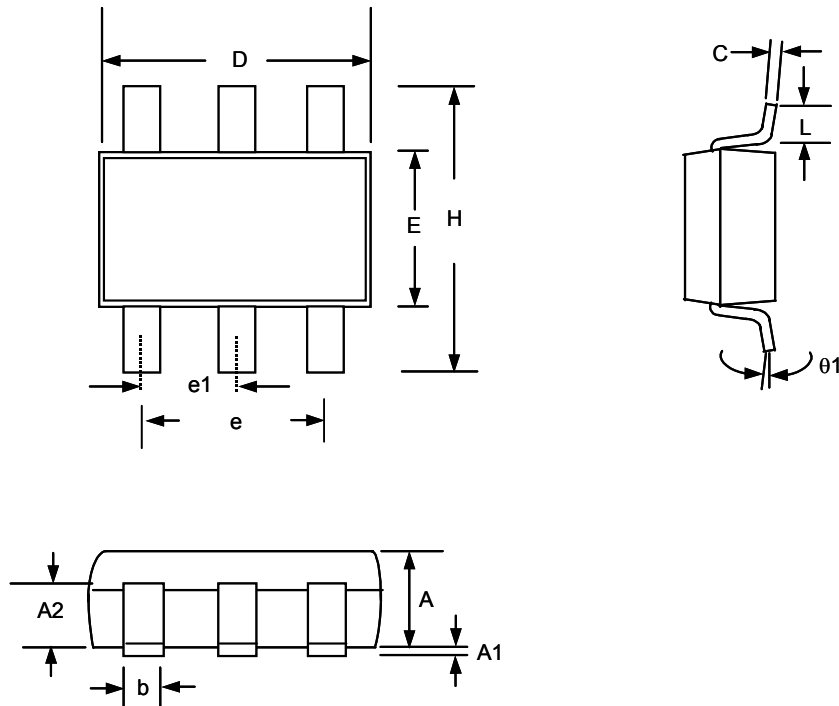

Fig.2 Turn ON and config Code N

Package Information



SOT-23-6 (TB) Package

Note:

1. Package body sizes exclude mold flash protrusions or gate burrs
2. Tolerance ± 0.1000 mm (4mil) unless otherwise specified
3. Coplanarity: 0.1000mm
4. Dimension L is measured in gage plane

SYMBOL	DIMENSIONS IN MILLIMETER		
	MIN	NOM	MAX
A	1.00	1.10	1.30
A1	0.00	-----	0.10
A2	0.70	0.80	0.90
b	0.35	0.40	0.50
C	0.10	0.15	0.25
D	2.70	2.90	3.10
E	1.40	1.60	1.80
e	-----	1.90(TYP)	-----
e1	-----	0.95	-----
H	2.60	2.80	3.00
L	0.37	-----	-----
$\theta 1$	1°	5°	9°

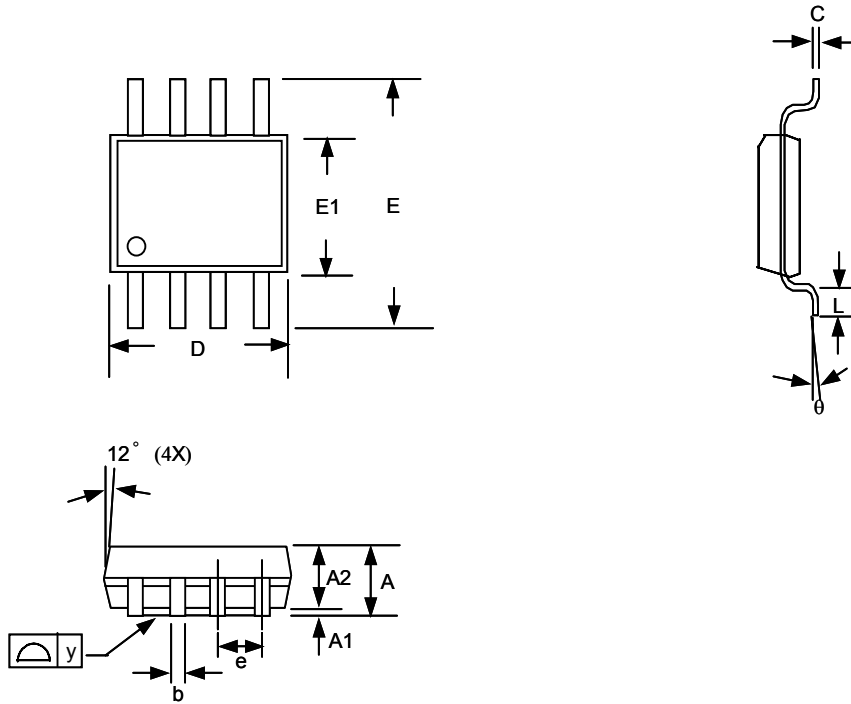

MSOP-8 (P8) Package

Note:

1. Package body sizes exclude mold flash and gate burrs
2. Dimension L is measured in gage plane
3. Tolerance 0.10mm unless otherwise specified
4. Controlling dimension is millimeter converted inch dimensions are not necessarily exact.
5. Followed from JEDEC MO-137

SYMBOL	DIMENSION IN MM			DIMENSION IN INCH		
	MIN.	NOM.	MAX.	MIN.	NOM.	MAX.
A	0.81	1.02	1.22	0.032	0.040	0.048
A1	0.00	----	0.20	0.000	----	0.008
A2	0.76	0.86	0.97	0.030	0.034	0.038
b	0.28	0.30	0.38	0.011	0.012	0.015
C	0.13	0.15	0.23	0.005	0.006	0.009
D	2.90	3.00	3.10	0.114	0.118	0.122
E	4.80	4.90	5.00	0.189	0.193	0.197
E1	2.90	3.00	3.10	0.114	0.118	0.122
e	----	0.65	----	----	0.026	----
L	0.40	0.53	0.66	0.016	0.021	0.026
y	----	----	0.10	----	----	0.004
θ	0°	----	6°	0°	----	6°

Taping Specification

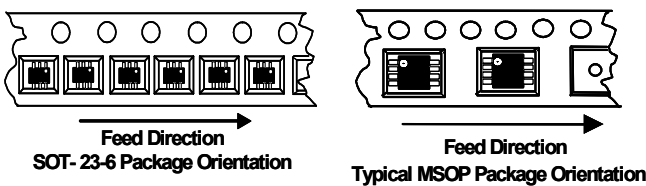

PACKAGE	Q'TY/REEL
SOT-23-6	3,000 ea
MSOP-8	2,500 ea

GMT Inc. does not assume any responsibility for use of any circuitry described, no circuit patent licenses are implied and GMT Inc. reserves the right at any time without notice to change said circuitry and specifications.