

G5ELM2576

Simple Switcher 3A Step-Down Voltage Regulator

Description

The G5ELM2576 series of regulators are monolithic integrated circuits that provide all active functions for a step-down (buck) switching regulator, capable of driving 3A load with excellent line and load regulation. These devices are available in fixed output voltage of 3.3v, 5v, 12v, 15v and an adjustable output version. Requiring a minimum number of external components, these regulators are simple to use and include internal frequency compensation and a fixed-frequency oscillator.

The G5ELM2576 series offers a high-efficiency replacement for popular three-terminal linear regulators. It substantially reduces the size of the heat sink, and in some cases no heat sink is required.

A standard series of inductors optimized for use with the G5ELM2576 are available from several different manufacturers. This feature greatly simplifies the design of switch-mode power supplies. Other features include a guaranteed $\pm 4\%$ tolerance on output voltage within specified input voltages and output load condition, and $\pm 10\%$ on the oscillator frequency. External shutdown is included, featuring 50uA (typical) standby current. The output switch includes cycle-by-cycle current limiting, as well as thermal shutdown for full protection under fault condition.

Features

- 3.3V, 5.0V, 12V, 15V and adjustable output versions
- Adjustable version output voltage range , 1.23V to 37V $\pm 4\%$ max over line and load conditions
- Guaranteed 3A output current
- Wide input voltage range
- Efficient pre-regulator for linear regulators
- Requires only 4 external components
- 52kHz fixed frequency oscillator
- TTL shutdown capability, low power standby mode
- High efficiency
- Uses readily available standard inductors
- Thermal shutdown and current limit protection

Applications

- Simple high-efficiency step-down (buck) regulator
- On-card switching regulators
- Positive to negative converter (Buck-Boost)

Package Dimensions

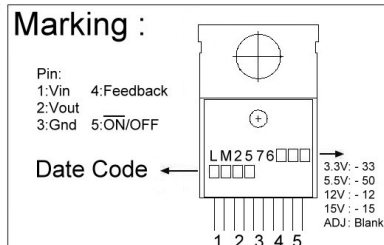
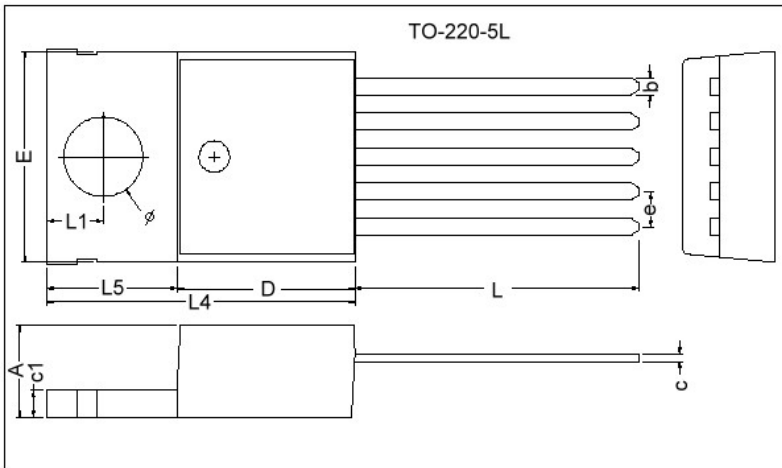

REF.	Millimeter		REF.	Millimeter	
	Min.	Max.		Min.	Max.
A	4.40	4.80	L5	6.20	6.60
b	0.76	1.00	c1	1.25	1.45
c	0.36	0.50	L	13.25	14.25
D	8.60	9.00	e	1.70 REF.	
E	9.80	10.4	L1	2.60	2.89
L4	14.7	15.3	Ø	3.71	3.96

Typical Application (Fixed Output Voltage Version)

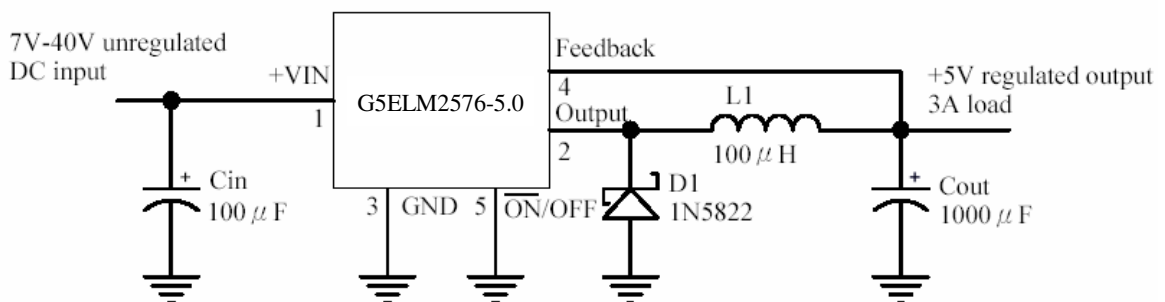
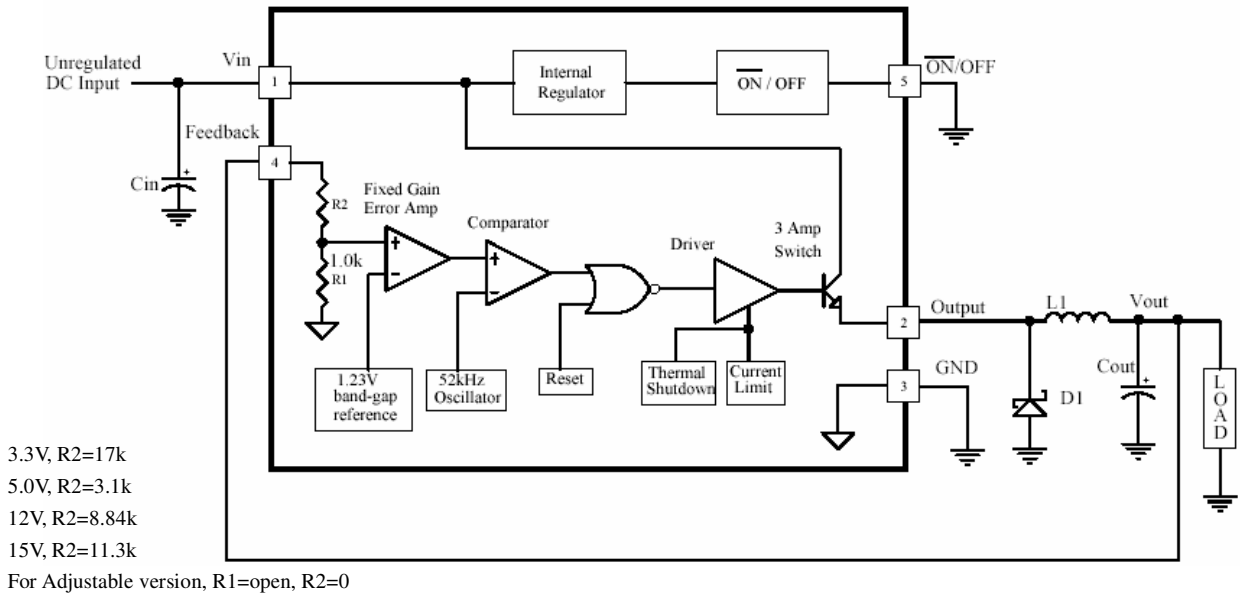

Figure. 1

Block Diagram



Absolute Maximum Ratings (Note1)

Parameter	Ratings	Unit
Maximum Supply Voltage	45	V
ON/OFF pin input Voltage	$-0.3 \leq V \leq +V_{IN}$	V
Output Voltage to ground (steady state)	-1	V
Power dissipation	Internally Limited	
Storage Temperature	$-65 \sim +150$	°C
Maximum junction temperature	+150	°C
Minimum ESD rating (C=100pF, R=1.5kΩ)	2k	V
Lead temperature (soldering, 10seconds)	+260	°C

Operating Ratings

Parameter	Ratings	Unit
Temperature range	$-40 \leq T_J \leq +125$	°C
Supply Voltage	40	V

G5ELM2576-3.3 Electrical Characteristics

Specifications with standard type face are for $T_J=25^\circ\text{C}$, and those with **boldface type** apply over full operating temperature range

Parameter	Symbol	Conditions	Min	Typ	Max	Unit
System Parameters (Note3) Test Circuit Figure 2						
Output Voltage	V _{OUT}	V _{IN} =12V, I _{LOAD} =0.5A Circuit of Figure 2	3.234	3.3	3.366	V
Output Voltage	V _{OUT}	$6V \leq V_{IN} \leq 40V$, $0.5A \leq I_{LOAD} \leq 3A$ Circuit of Figure 2	3.168/ 3.135	3.3	3.432/ 3.465	V
Efficiency	η	V _{IN} =12V, I _{LOAD} =3A		75		%

G5ELM2576-5.0 Electrical Characteristics

Specifications with standard type face are for $T_J=25^\circ\text{C}$, and those with **boldface type** apply over full operating temperature range

Parameter	Symbol	Conditions	Min	Typ	Max	Unit
System Parameters (Note3) Test Circuit Figure 2						
Output Voltage	V _{OUT}	V _{IN} =12V, I _{LOAD} =0.5A Circuit of Figure 2	4.9	5.0	5.1	V
Output Voltage	V _{OUT}	$8V \leq V_{IN} \leq 40V$, $0.5A \leq I_{LOAD} \leq 3A$ Circuit of Figure 2	4.80/ 4.75	5.0	5.20/ 5.25	V
Efficiency	η	V _{IN} =12V, I _{LOAD} =3A		77		%

G5ELM2576-12 Electrical Characteristics

Specifications with standard type face are for $T_J=25\text{ }^\circ\text{C}$, and those with **boldface type** apply over full operating temperature range

Parameter	Symbol	Conditions	Min	Typ	Max	Unit
System Parameters (Note3) Test Circuit Figure 2						
Output Voltage	V _{OUT}	V _{IN} =25V, I _{LOAD} =0.5A Circuit of Figure 2	11.76	12	12.24	V
Output Voltage	V _{OUT}	15V ≤ V _{IN} ≤ 40V, 0.5A ≤ I _{LOAD} ≤ 3A Circuit of Figure 2	11.52/ 11.40	12	12.48/ 12.60	V
Efficiency	η	V _{IN} =15V, I _{LOAD} =3A		88		%

G5ELM2576-15 Electrical Characteristics

Specifications with standard type face are for $T_J=25\text{ }^\circ\text{C}$, and those with **boldface type** apply over full operating temperature range

Parameter	Symbol	Conditions	Min	Typ	Max	Unit
System Parameters (Note3) Test Circuit Figure 2						
Output Voltage	V _{OUT}	V _{IN} =25V, I _{LOAD} =0.5A Circuit of Figure 2	14.70	15	15.30	V
Output Voltage	V _{OUT}	18V ≤ V _{IN} ≤ 40V, 0.5A ≤ I _{LOAD} ≤ 3A Circuit of Figure 2	14.40/ 14.25	15	15.60/ 15.75	V
Efficiency	η	V _{IN} =18V, I _{LOAD} =3A		88		%

G5ELM2576 Electrical Characteristics

Specifications with standard type face are for $T_J=25\text{ }^\circ\text{C}$, and those with **boldface type** apply over full operating temperature range

Parameter	Symbol	Conditions	Min	Typ	Max	Unit
System Parameters (Note3) Test Circuit Figure 2						
Output Voltage	V _{OUT}	V _{IN} =12V, I _{LOAD} =0.5A, V _{OUT} =5V Circuit of Figure 2	1.217	1.230	1.243	V
Output Voltage	V _{OUT}	8V ≤ V _{IN} ≤ 40V, 0.5A ≤ I _{LOAD} ≤ 3A V _{OUT} =5V, Circuit of Figure 2	1.193/ 1.180	1.230	1.267/ 1.280	V
Efficiency	η	V _{IN} =12V, I _{LOAD} =3A, V _{OUT} =5V		77		%

All Output Voltage Version Electrical Characteristics

Specifications with standard type face are for $T_J=25\text{ }^\circ\text{C}$, and those with **boldface type** apply over full operating temperature range.

Unless otherwise specified, V_{IN}=12V for the 3.3V, 5.0V and Adjustable versions, V_{IN}=25V for 12V version, and V_{IN}=30V for 15V version.

I_{LOAD}=0.5A

Parameter	Symbol	Conditions	Min	Typ	Max	Unit
Feedback bias current	I _b	V _{OUT} =5V (adjustable version only)	-	50	100/ 500	nA
Oscillator frequency	f _o	(Note 8)	47/ 42	52	58/ 63	kHz
Saturation voltage	V _{SAT}	I _{LOAD} =3A (Note 4)	-	1.4	1.8/ 2.0	V
Maximum duty cycle (ON)	DC	(Note 5)	93	98		%
Current limit	I _{CL}	(Note 4, 8)	4.2/ 3.5	5.8	6.9/ 7.5	A
Output leakage current	I _L	(Note 6, 7) Output=0V Output=-1V	- -	- 7.5	2 30	mA
Quiescent current	I _Q	(Note 6)	-	5	10	mA
Standby quiescent current	I _{STBY}	$\overline{\text{ON}}$ /OFF pin=5V (OFF)	-	50	200	uA
ON/OFF Control						
ON/OFF pin logic input level	V _{IH}	V _{OUT} =0V	2.2/ 2.4	1.4	-	V
	V _{IL}	V _{OUT} =Nominal output voltage	-	1.2	1.0/ 0.8	
ON/OFF pin input current	I _{IH}	$\overline{\text{ON}}$ /OFF pin=5V (OFF)	-	12	30	uA
	I _{IL}	$\overline{\text{ON}}$ /OFF pin=0V (ON)	-	0	10	

Note 1: Absolute Maximum Rating indicate limits beyond which damage to the device may occur. Operating Rating indicate conditions for which the device is intended to be functional, but do not guaranteed specific performance limits. For guaranteed specifications and test conditions, see the Electrical Characteristics.

Note 2: All limits guaranteed at room temperature (standard type face) and at temperature extremes (bold type face).

Note 3: External component such as the catch diode, inductor, input and output capacitors can affect switching regulator system performance. When the G5ELM2576 is used as shutdown in the Figure 2 test circuit, system performance will be as shown in system parameters section of Electrical Characteristics.

Note 4: Output pin sourcing current. No diode, inductor or capacitor connected to output.

Note 5: Feedback pin removed from output and connected to 0V.

Note 6: Feedback pin removed from output and connected to +12V for the Adjustable, 3.3V and 5V versions, and +25V for the 12V and 15V versions, to force the output transistor OFF.

Note 7: $V_{IN}=40V$.

Note 8: The oscillator frequency reduces to approximately 11 kHz in the event of an output short or an overload which causes the regulated output voltage to drop approximately 40% from the nominal output voltage. This self protection feature lowers the average power dissipation of the IC by lowering the minimum duty cycle from 5% down to approximately 2%.

Typical Performance Characteristics (circuit of Figure 2)

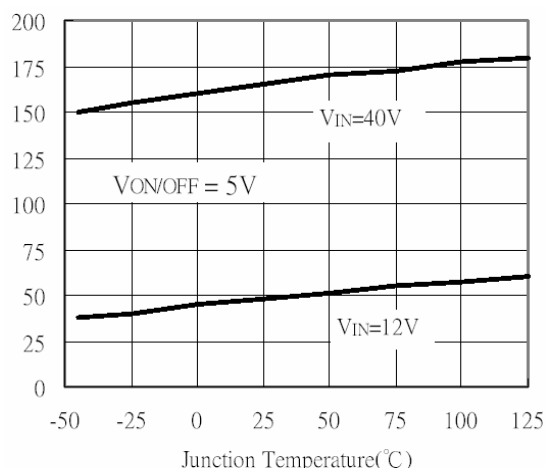
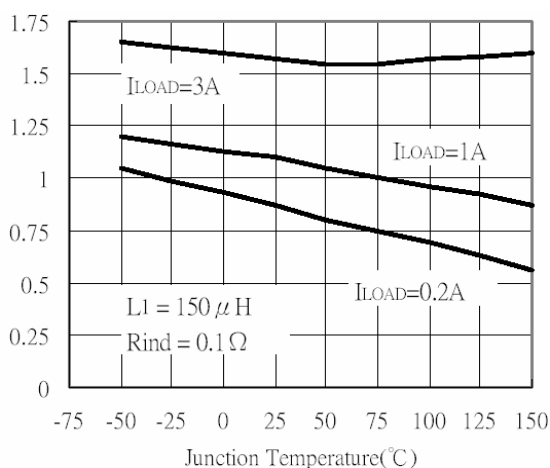
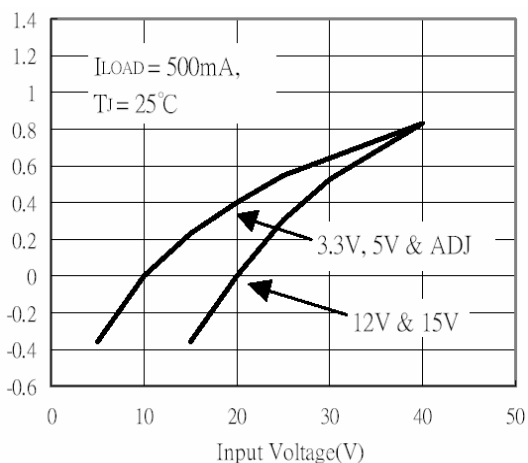
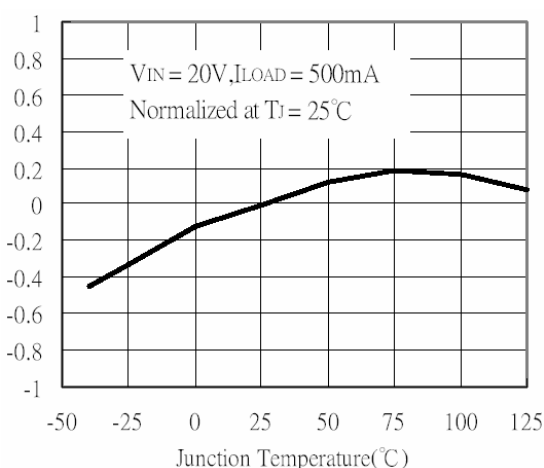

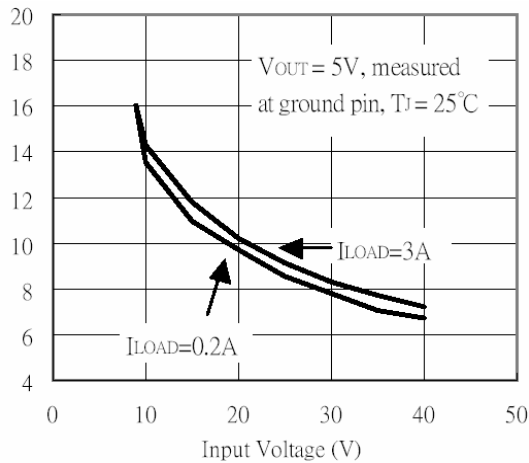

Quiescent Current

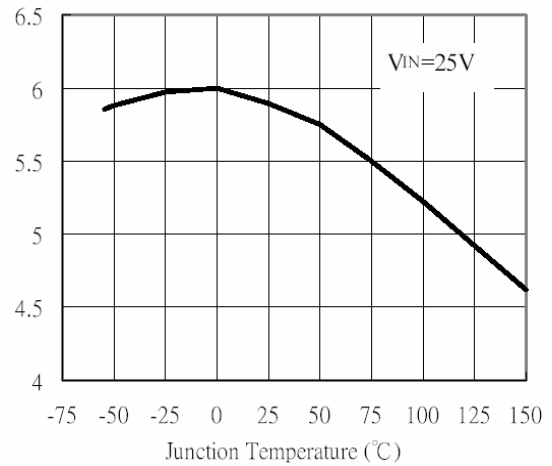

Current Limit

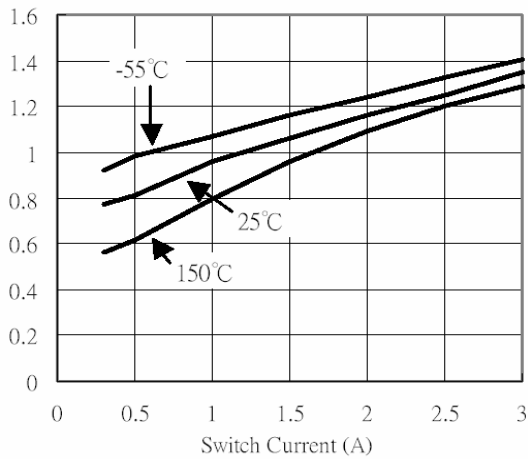

Switch Saturation Voltage

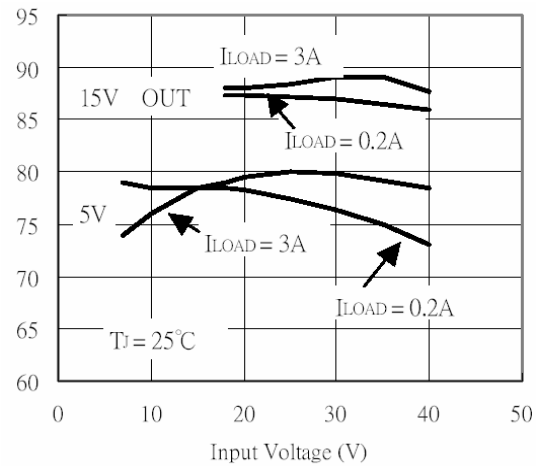

Efficiency

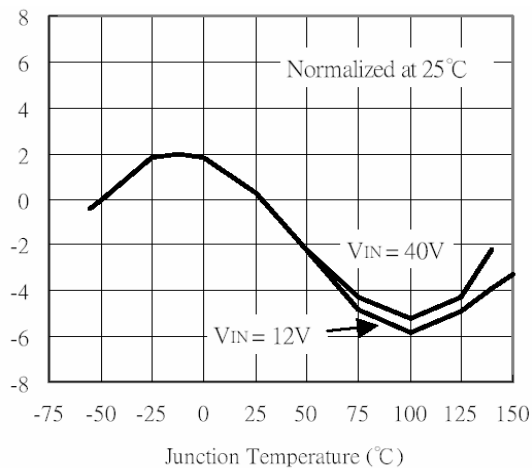

Oscillator Frequency

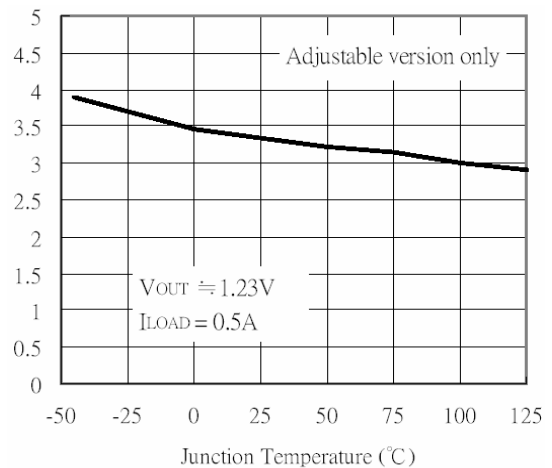

Minimum Operating voltage

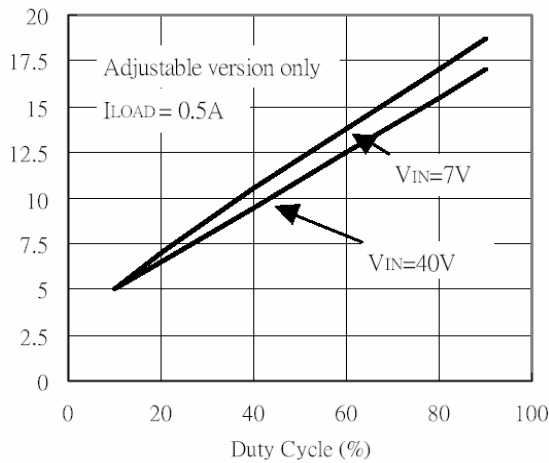

Quiescent Current vs Duty Cycle

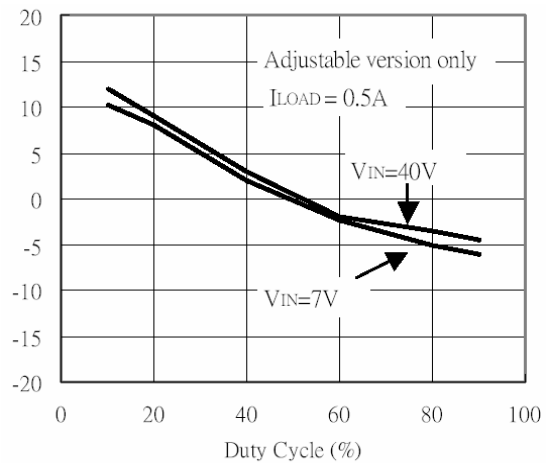

Feedback Voltage vs Duty Cycle

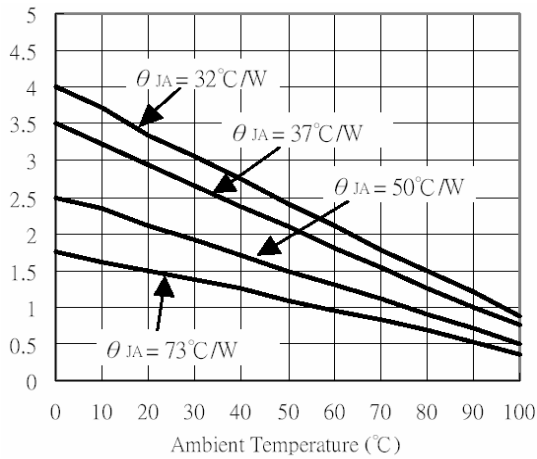

Minimum Power Dissipation

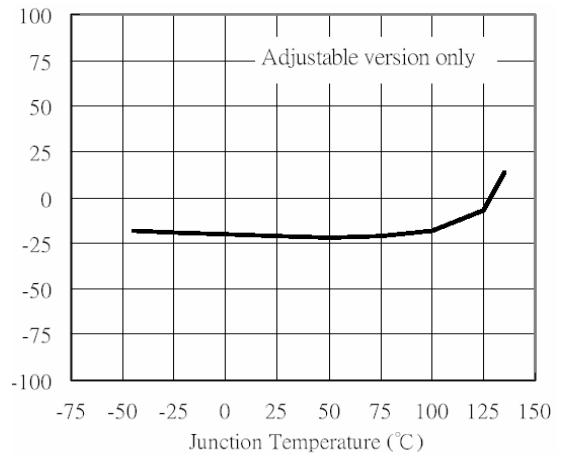

Feedback Pin Current

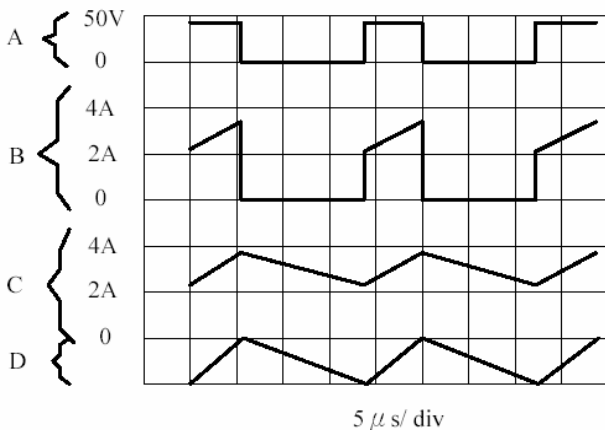

Switching Waveforms

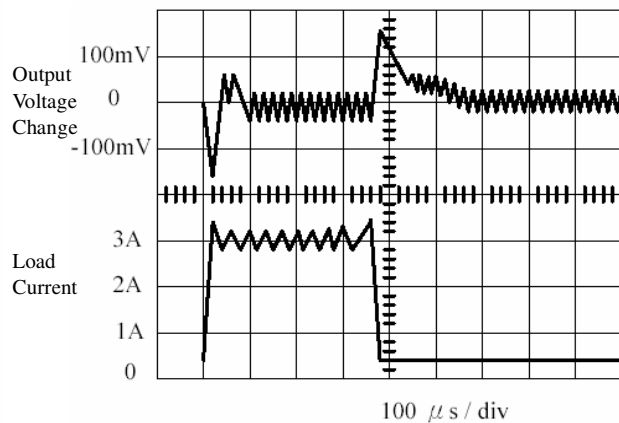

Load Transient Response

VOUT=15V
 A: Output Pin Voltage, 50V/div
 B: Output Pin Current, 2A/div
 C: Inductor Current, 2A/div
 D: Output Ripple Voltage, 50mV/div
 AC Coupled
 Horizontal Time Base: 5μs/div

Test Circuit and layout Guidelines

As in any switching regulator, layout is very important. Rapidly switching currents associated with wiring inductance generate voltage transients which can cause problems. For minimal inductance and ground loops, the length of the leads indicated by heavy lines should be kept as short as possible. Single-point grounding (as indicated) or ground plane construction should be used for best results. When using the Adjustable version, physically locate the programming resistors near the regulator, to keep the sensitive feedback wiring short.

Fixed Output Voltage Versions

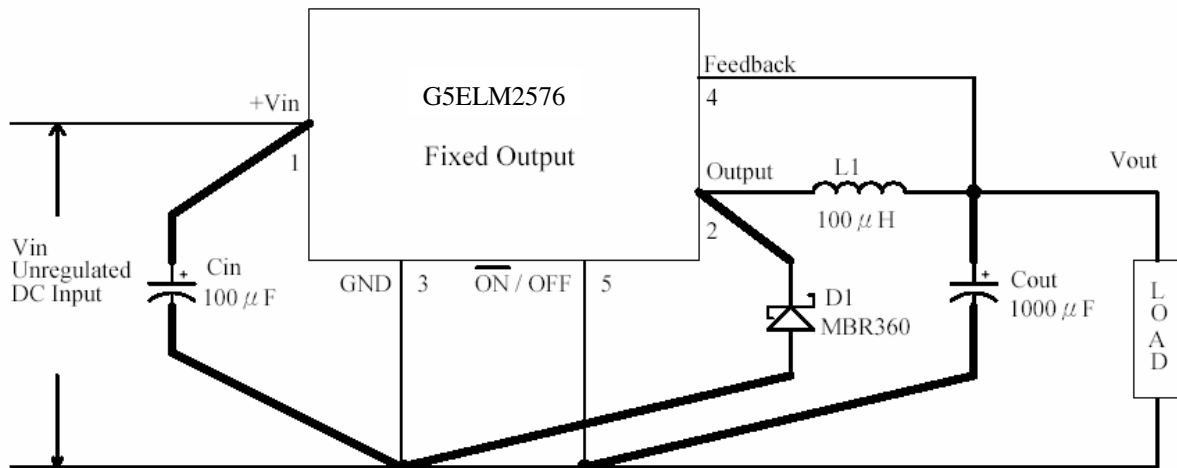

Cin-- 100uF, 75V, Aluminum Electrolytic
Cout-- 1000uF, 25V Aluminum Electrolytic
D1-- Schottky, MBR360
L1-- 100uH, Pulse Eng, PE92108
R1-- 2k, 0.1%
R1-- 6.12k, 0.1%

Adjustable Output Voltage Version

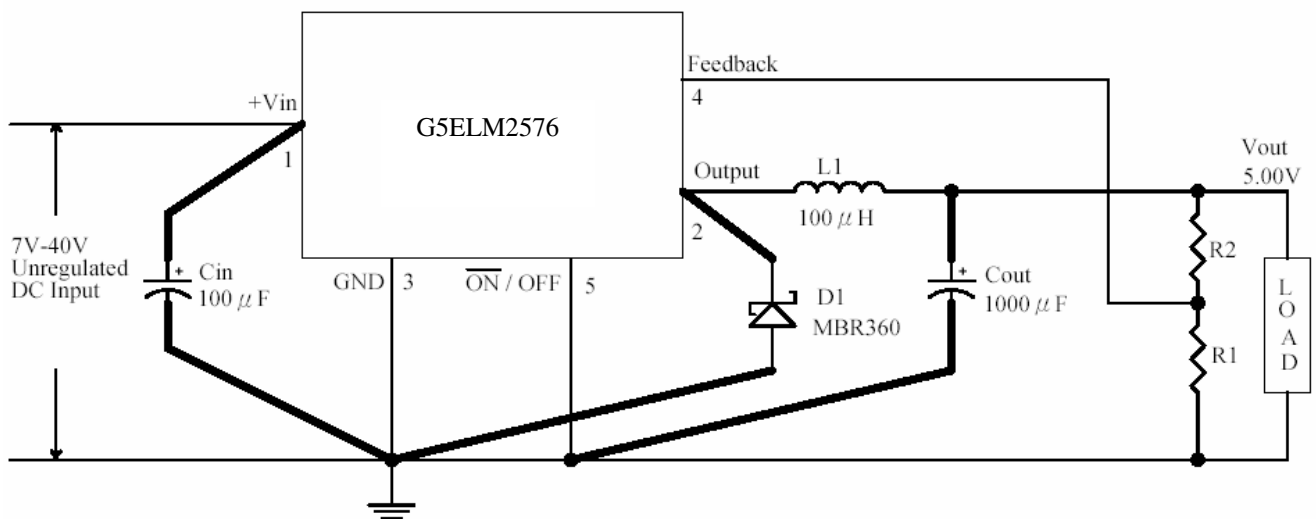

Where VREF=1.23V, R1 between 1k and 5k

Figure 2

Important Notice:

- All rights are reserved. Reproduction in whole or in part is prohibited without the prior written approval of GTM.
- GTM reserves the right to make changes to its products without notice.
- GTM semiconductor products are not warranted to be suitable for use in life-support Applications, or systems.
- GTM assumes no liability for any consequence of customer product design, infringement of patents, or application assistance.

Head Office And Factory:

- **Taiwan:** No. 17-1 Tatung Rd. Fu Kou Hsin-Chu Industrial Park, Hsin-Chu, Taiwan, R. O. C.
- TEL : 886-3-597-7061 FAX : 886-3-597-9220, 597-0785
- **China:** (201203) No.255, Jang-Jiang Tsai-Lueng RD. , Pu-Dung-Hsin District, Shang-Hai City, China
- TEL : 86-21-5895-7671 ~ 4 FAX : 86-21-38950165