

G5J2167

750mA CMOS Positive Voltage Regulator

Description

The G5J2167 series of positive, linear regulators feature low quiescent current (45µA typ.) with low dropout voltage, making them ideal for battery applications.

Output voltages are set at the factory and trimmed to 1.5% accuracy.

These rugged devices have both Thermal Shutdown, and Current Fold-back to prevent device failure under the "Worst" of operating conditions.

An additional feature is a "Power Good" detector, which pulls low when the output is out of regulation.

The G5J2167 is stable with an output capacitance of 4.7µF or greater.

Features

- Very Low Dropout Voltage
- Guaranteed 750mA output
- Over-Temperature Shutdown
- Current Limiting
- Short Circuit Current Fold-back
- Low Temperature Coefficient
- Noise Reduction Bypass Capacitor
- Power-saving Shutdown Mode
- Power Good Output Function

Applications

- Battery Powered Widgets
- Instrumentation
- Wireless Devices
- PC Peripherals
- Portable Electronics

Package Dimensions

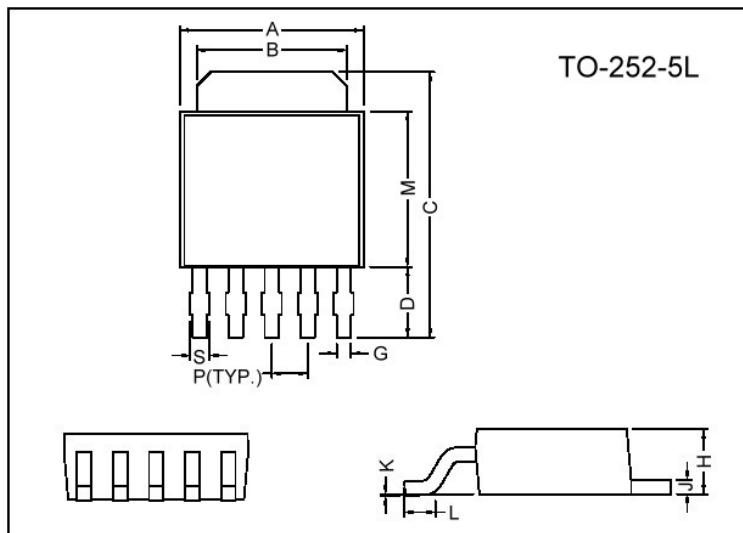

Functional Block Diagram

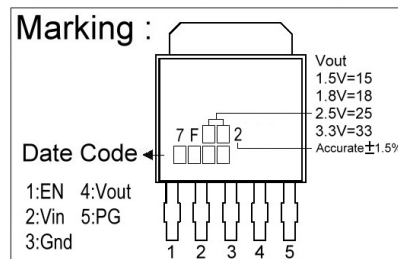
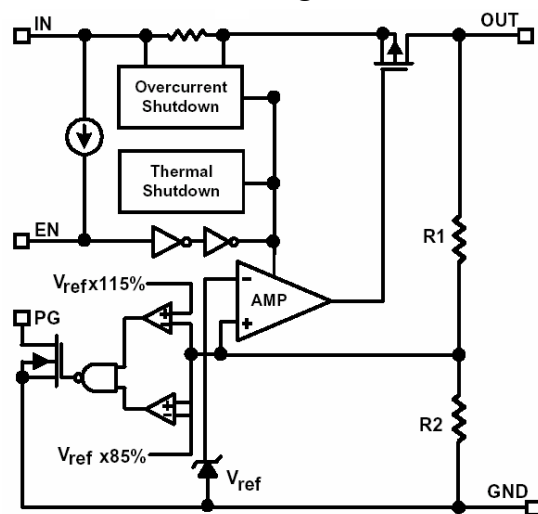

REF.	Millimeter		REF.	Millimeter	
	Min.	Max.		Min.	Max.
A	6.35	6.73	G	0.45	0.60
B	5.21	5.46	H	2.20	2.40
C	9.40	10.20	J	0.46	0.58
D	2.40	3.00	K	0	0.15
P	1.27 REF.		L	0.90	1.50
S	0.50	0.80	M	5.40	5.59

Typical Application Circuit

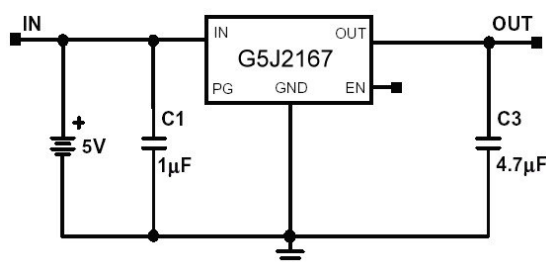

Absolute Maximum Ratings

Parameter	Symbol	Ratings	Unit
Input Max Voltage	V _{IN}	8	V
Output Current	I _{OUT}	PD/(V _{IN} -V _O)	mA
Output Voltage	V _{OUT}	1.5~3.3	V
Operating Ambient Temperature	T _{opr}	-40 ~ +85	°C
Junction Temperature	T _j	-40 ~ +125	°C
Maximum Junction Temperature	T _{j Max}	150	°C
Internal Power Dissipation(ΔT=100°C)	P _D	1.2	W
EDS Classification		B	

Electrical Characteristics TA=25°C unless otherwise noted(V_{IN}=V_{OUT(T)}+2V, V_{EN}=V_{IN}, C_{IN}=1Uf, C_{OUT}=4.7Uf)

Parameter	Symbol	Condition	Min	TYP	Max	Unit	
Output Voltage	V _{OUT(E)} (Note1)	I _O =1mA, V _{IN} =V _{OUT(T)} +2V	-1.5	V _{OUT(T)} (Note2)	1.5	%	
Output Current	I _O	V _O >1.2V	750	-	-	mA	
Current Limit	I _{LIM}	V _O >1.2V	750	-	-	mA	
Short Circuit Current	I _{SC}	V _{IN} =V _{OUT(T)} +1V, V _O <0.4V	-	750	-	mA	
Load Regulation	REG _{LOAD}	V _{IN} =V _{OUT(T)} +2V, I _O =1mA to 750mA	-1	0.2	1	%	
Dropout Voltage	V _{DROPOUT}	I _O =750mA V _O =V _{OUT(E)} -2%	V _{OUT(T)} =1.5V	-	-	1000	mV
			V _{OUT(T)} =1.8V	-	-	650	
			V _{OUT(T)} ≥2.0V	-	-	500	
Quiescent Current	I _Q	V _{IN} =V _{OUT(T)} +2V, I _O =0mA	-	45	70	μA	
Ground Pin Current	I _{IGND}	V _{IN} =V _{OUT(T)} +2V, I _O =1mA to 750mA	-	45	-	μA	
Line Regulation	REG _{LINE}	I _O =1mA V _{IN} =V _{OUT(T)} +1 to V _{OUT(T)} +2	V _{OUT(T)} <2.0V	-0.15	-	0.15	%
			2.0V≤V _{OUT(T)} <4.0V	-0.1	0.02	0.1	
			4.0V≤V _{OUT(T)}	-0.4	-	0.4	
Input Voltage	V _{IN}		Note3	-	7	V	
Over Temperature Shutdown	OTS		-	150	-	°C	
Over Temperature Hysteresis	OTH		-	30	-	°C	
Output Voltage Temperature Coefficient	TC		-	30	-	ppm/°C	
Power Supply Rejection	PSRR	I _O =100mA Co=4.7μF (ceramic)	f=1kHz	-	75	-	dB
			f=10kHz	-	55	-	
			f=100kHz	-	30	-	
Output Voltage Noise	e _N	f=10Hz~100kHz, I _O =10mA, Co=4.7μF	-	30	-	μVrms	
EN Input Threshold	V _{EH}	V _{IN} =2.7V to 7V	2.0	-	V _{IN}	V	
	V _{EL}	V _{IN} =2.7V to 7V	0	-	0.4	V	
EN Input Bias Current	I _{EH}	V _{EN} =V _{IN} , V _{IN} =2.7V to 7V	-	-	1	μA	
	I _{EL}	V _{EN} =0V, V _{IN} =2.7V to 7V	-	-	1	μA	
Shutdown Supply Current	I _{SD}	V _{IN} =5V, V _O =0V, V _{EN} <V _{EL}	-	0.5	2	μA	
Output Under Voltage	V _{UV}	PG goes Low when V _{OUT} too Low	-	-	84	% V _{OUT(T)}	
Output Over Voltage	V _{OV}	PG goes Low when V _{OUT} too High	105	-	-	% V _{OUT(T)}	
PG Leakage Current	I _{LC}	V _{PG} =7V	-	-	1.0	μA	
PG Voltage Low	V _{OL}	I _{SINK} =0.25mA	-	-	0.4	V	

Note 1: V_{OUT(E)} =Effective Output Voltage (i.e. the output voltage when "V_{OUT(T)}+2.0V" is provided at the V_{IN} pin while maintaining a certain I_{OUT} value).

2: V_{OUT(T)} =Specified Output Voltage

3: V_{IN(MIN)} =V_{OUT}+V_{DROPOUT}

Ordering Information (contd.)

Part Number	Marking	Output Voltage	Part Number	Marking	Output Voltage
G5J2167-15	7F152 XXXX	1.5V	G5J2167-18	7F182 XXXX	1.8V
G5J2167-25	7F252 XXXX	2.5V	G5J2167-33	7F332 XXXX	3.3V

Detailed Description

The G5J2167 series of COMS regulators contain a PMOS pass transistor, voltage reference, error amplifier, over-current protection, and thermal shutdown.

The P-channel pass transistor receives data from the error amplifier, over-current shutdown, and thermal protection circuits. During normal operation, the error amplifier compares the output voltage to a precision reference. Over-current and Thermal shutdown circuits become active when the junction temperature exceeds 140°C, or the current exceeds 2.2A. During thermal shutdown, the output voltage remains low. Normal operation is restored when the junction temperature drops below 120°C.

The G5J2167 behaves like a current source when the load reaches 2.2A. However, if the load impedance drops below 0.3ohms, the current drops back to 600mA to prevent excessive power dissipation. Normal operation is restored when the load resistance exceeds 0.75ohms.

External Capacitors

The G5J2167 is stable with an output capacitance to ground of 4.7μF or greater. Ceramic capacitors have the lowest ESR, and will offer the best AC performance. Conversely, Aluminum Electrolytic capacitors exhibit the highest ESR, resulting in the poorest AC response. Unfortunately, large value ceramic capacitors are comparatively expensive. One option is to parallel a 0.1μF ceramic capacitor with a 10μF Aluminum Electrolytic. The benefit is low ESR, high capacitance, and low overall cost.

A second capacitor is recommended between the input and ground to stabilize V_{IN}. The input capacitor should be at least 0.1μF to have a beneficial effect.

All capacitors should be placed in close proximity to the pins. A "Quiet" ground termination is desirable. This can be achieved with a "Star" connection.

Enable

When EN pin is pulled low, the PMOS pass transistor shuts off, and all internal circuits are powered down. In this state, the quiescent current is less than 2μA. This pin behaves much like an electronic switch.

100KΩ resistor is necessary between V_{EN} source and EN pin when V_{EN} is high than V_{IN}.

(Note: There is no internal pull-up for EN pin. It can not be floating.)

Power Good

The G5J2167 includes the Power Good feature. When the output is not within ±15% of the specified voltage, it pulls low. This can occur under the following conditions:

- 1) Input Voltage too low.
- 2) During Over-Temperature.
- 3) During Over-Current.
- 4) If output is pulled up.

(Note: PG pin is an open-drain output.)

Characteristics Curve

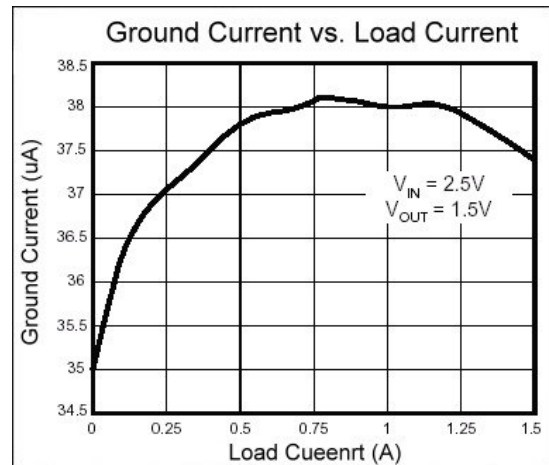
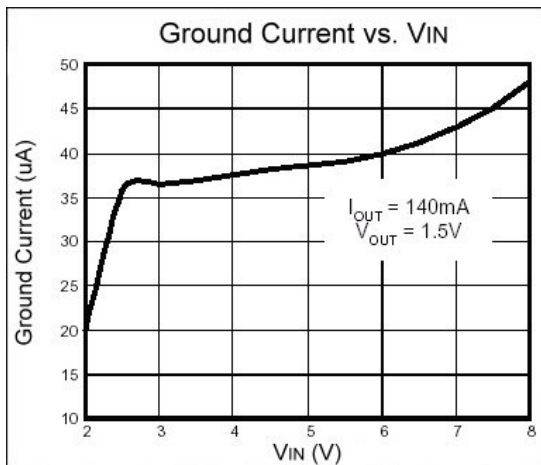
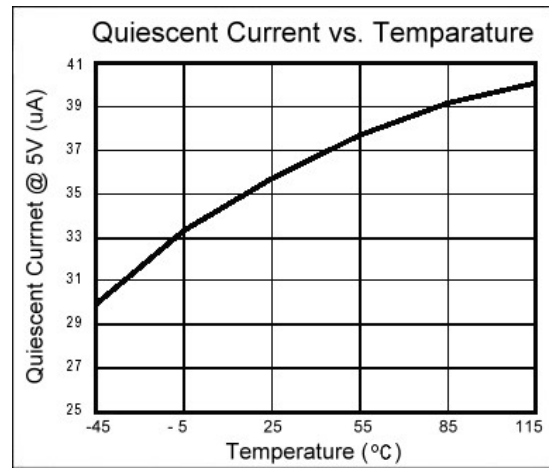
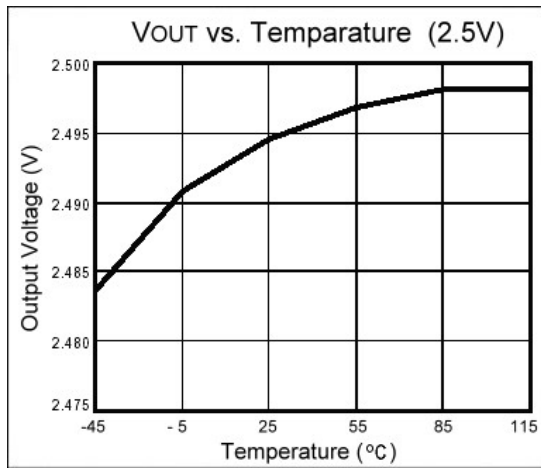
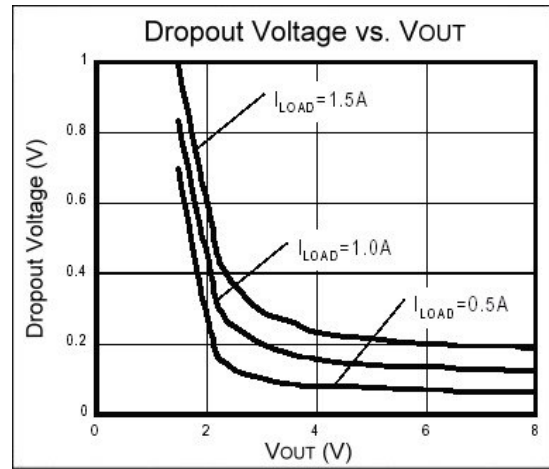
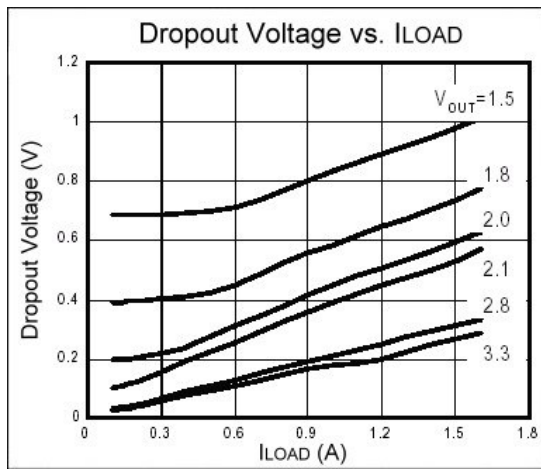

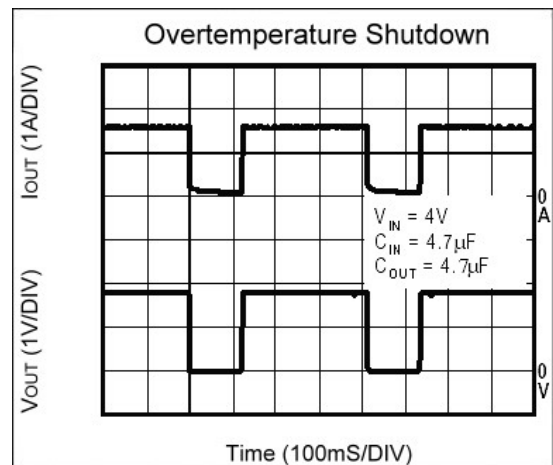
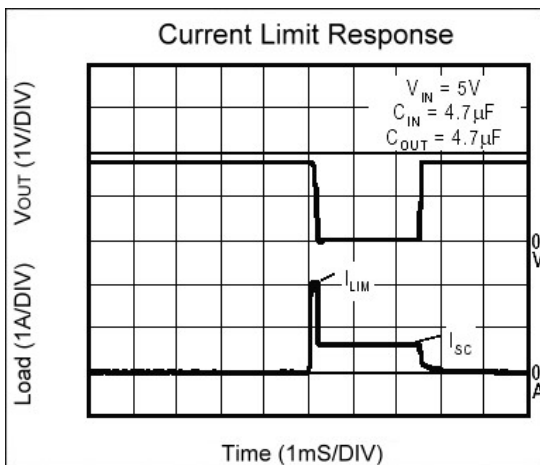
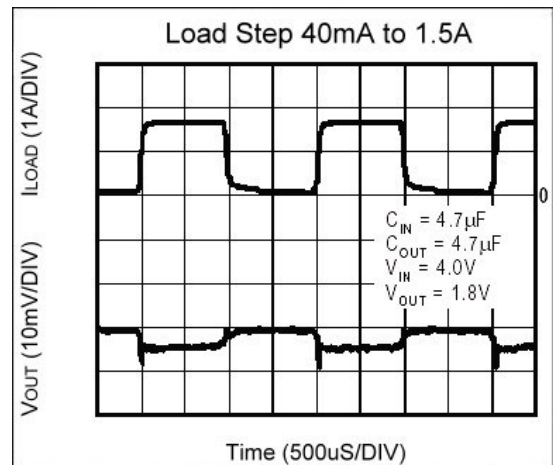
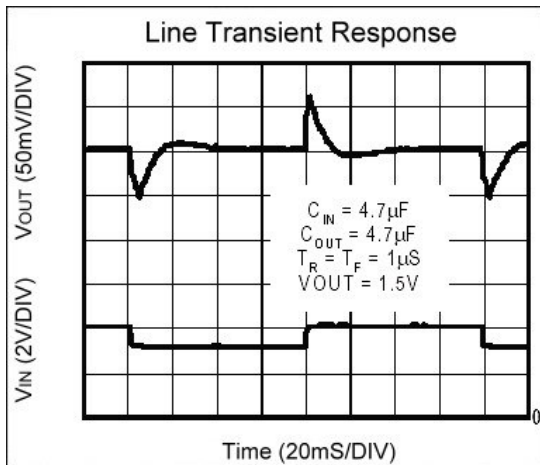
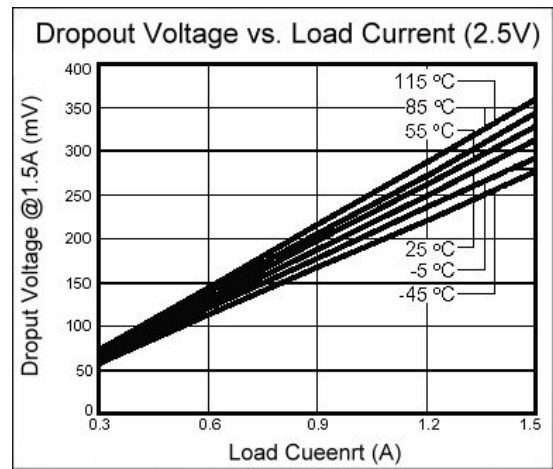
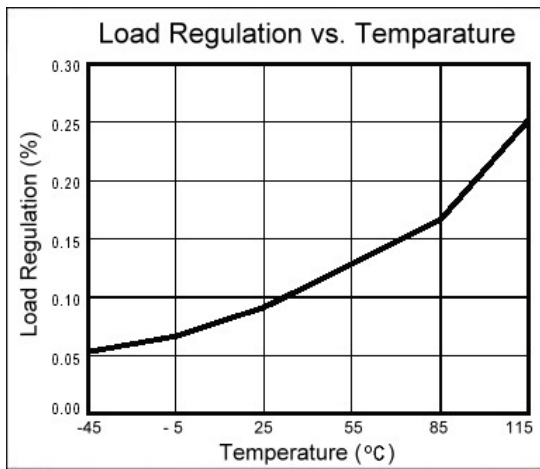

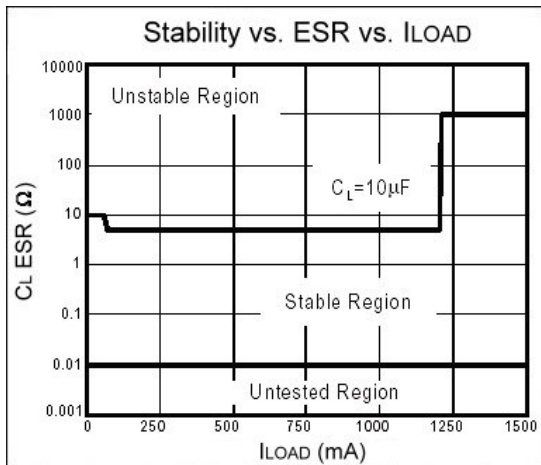
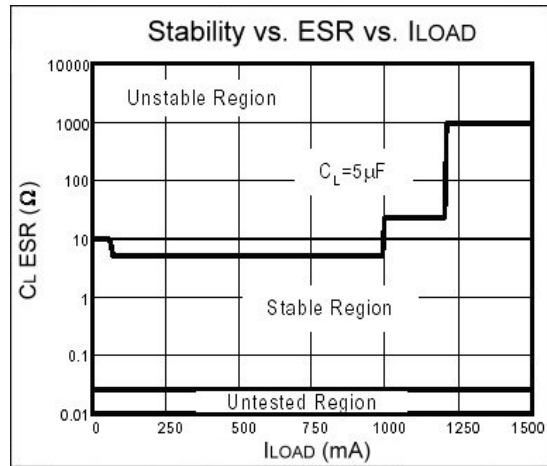
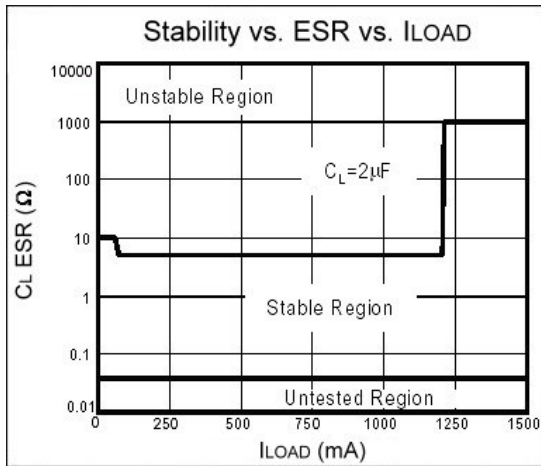
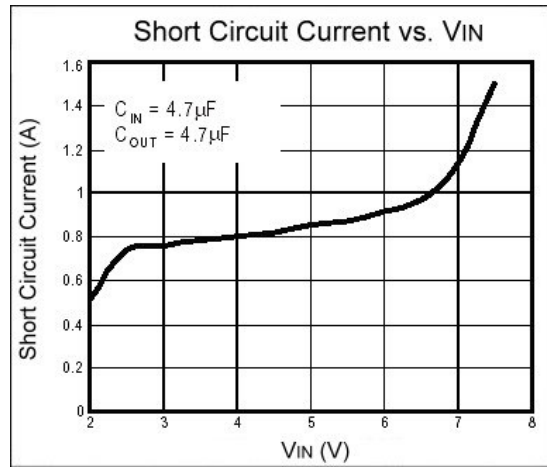
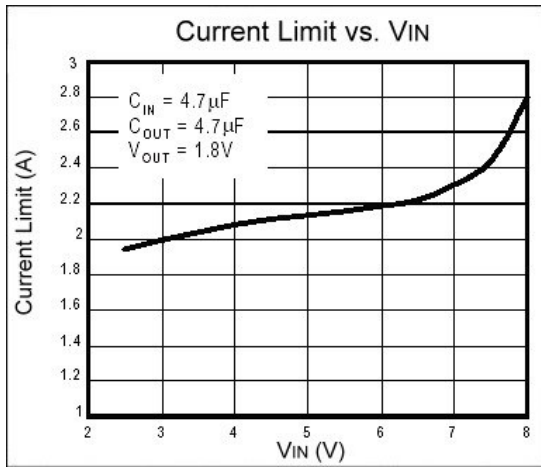

Important Notice:

- All rights are reserved. Reproduction in whole or in part is prohibited without the prior written approval of GTM.
- GTM reserves the right to make changes to its products without notice.
- GTM semiconductor products are not warranted to be suitable for use in life-support Applications, or systems.
- GTM assumes no liability for any consequence of customer product design, infringement of patents, or application assistance.

Head Office And Factory:

- Taiwan: No. 17-1 Tatung Rd. Fu Kou Hsin-Chu Industrial Park, Hsin-Chu, Taiwan, R. O. C.
- TEL : 886-3-597-7061 FAX : 886-3-597-9220, 597-0785
- China: (201203) No.255, Jang-Jiang Tsai-Lueng RD. , Pu-Dung-Hsin District, Shang-Hai City, China
- TEL : 86-21-5895-7671 ~ 4 FAX : 86-21-38950165