



# G65SC802 G65SC816

## Microcircuits

### CMOS 8-Bit/16-Bit Microprocessor Family

#### Features

- Advanced CMOS design for low power consumption and increased noise immunity
- Emulation mode for total software compatibility with 6502 designs
- Full 16-bit ALU, Accumulator, Stack Pointer, and Index Registers
- Direct Register for "zero page" addressing
- 24 addressing modes (including 13 original 6502 modes)
- Wait for Interrupt (WAI) and Stop the Clock (STP) instructions for reduced power consumption and decreased interrupt latency
- 91 instructions with 255 opcodes
- Co-Processor (COP) instruction and associated vector
- Powerful Block Move instructions

#### Features (G65SC802 Only)

- 8-Bit Mode with both software and hardware (pin-to-pin) compatibility with 6502 designs (64 KByte memory space)
- Program selectable 16-bit operation
- Choice of external or on-board clock generation

#### Features (G65SC816 Only)

- Full 16-bit operation with 24 address lines for 16 MByte memory
- Program selectable 8-Bit Mode for 6502 coding compatibility.
- Valid Program Address (VPA) and Valid Data Address (VDA) outputs for dual cache and DMA cycle steal implementation
- Vector Pull ( $\overline{VP}$ ) output indicates when interrupt vectors are being fetched. May be used for vectoring/prioritizing interrupts
- Abort interrupt and associated vector for interrupting any instruction without modifying internal registers
- Memory Lock ( $\overline{ML}$ ) for multiprocessor system implementation

#### General Description

The G65SC802 and G65SC816 are ADV-CMOS (ADVanced CMOS) 16-bit microprocessors featuring total software compatibility with 8-bit NMOS and CMOS 6500 series microprocessors. The G65SC802 is pin-to-pin compatible with 8-bit 6502 devices currently available, while also providing full 16-bit internal operation. The G65SC816 provides 24 address lines for 16 MByte addressing, while providing both 8-bit and 16-bit operation.

Each microprocessor contains an Emulation (E) mode for emulating 8-bit NMOS and CMOS 6500-Series microprocessors. A software switch determines whether the processor is in the 8-bit emulation mode or in the Native 16-bit mode. This allows existing 8-bit system designs to use the many powerful features of the G65SC802 and G65SC816.

The G65SC802 and G65SC816 provide the system engineer with many powerful features and options. A 16-bit Direct Page Register is provided to augment the Direct Page addressing mode, and there are separate Program Bank Registers for 24-bit memory addressing. Other valuable features include:

- An Abort input which can interrupt the current instruction without modifying internal registers.
- Valid Data Address (VDA) and Valid Program Address (VPA) outputs which facilitate dual cache memory by indicating whether a data or program segment is being accessed.
- Vector modification by simply monitoring the Vector Pull ( $\overline{VP}$ ) output.
- Block Move instructions.

GTE Microcircuits' G65SC802 and G65SC816 microprocessors offer the design engineer a new freedom of design and application, and the many advantages of state-of-the-art ADV-CMOS technology.

#### Simplified Block Diagram

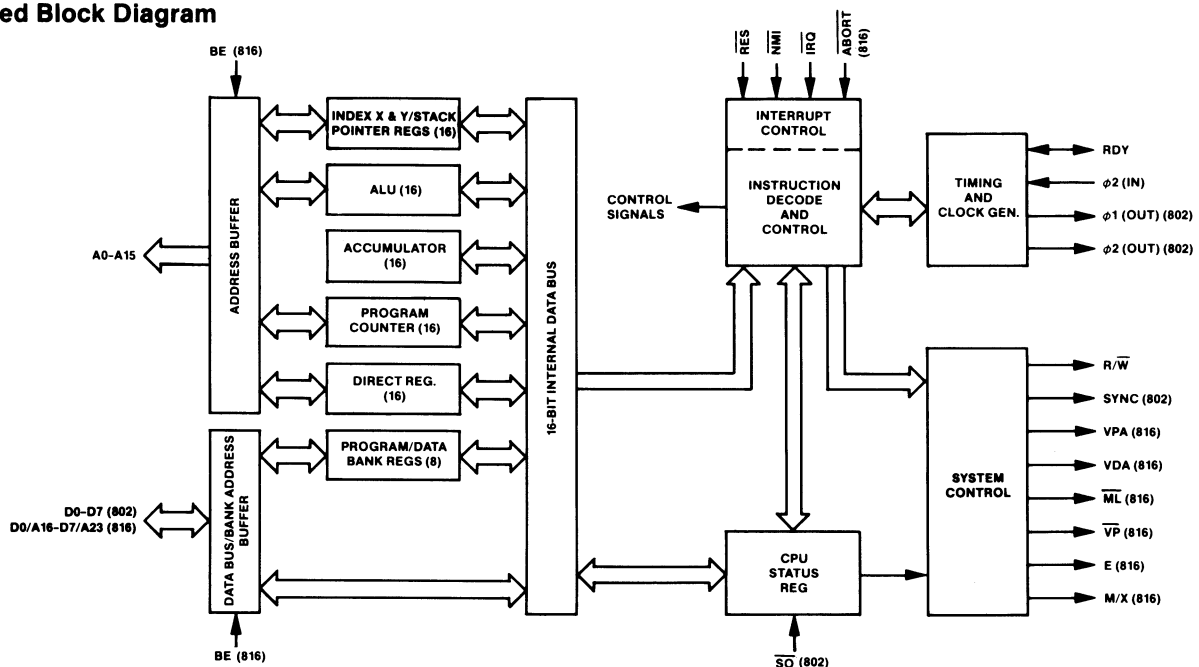

## ADVANCE INFORMATION

This is advanced information and specifications are subject to change without notice.

### Absolute Maximum Ratings: (Note 1)

Rating	Symbol	Value
Supply Voltage	V <sub>DD</sub>	-0.3V to +7.0V
Input Voltage	V <sub>IN</sub>	-0.3V to V <sub>DD</sub> + 0.3V
Operating Temperature	T <sub>A</sub>	0°C to +70°C
Storage Temperature	T <sub>S</sub>	-55°C to +150°C

This device contains input protection against damage due to high static voltages or electric fields; however, precautions should be taken to avoid application of voltages higher than the maximum rating.

Notes:

- Exceeding these ratings may cause permanent damage. Functional operation under these conditions is not implied.

### DC Characteristics (All Devices): V<sub>DD</sub> = 5.0V ±5%, V<sub>SS</sub> = 0V, T<sub>A</sub> = 0°C to +70°C

Parameter	Symbol	Min	Max	Unit
Input High Voltage RES, RDY, IRQ, Data, $\overline{SO}$ , BE ABORT, NMI, $\phi 2$ (IN)	V <sub>IH</sub>	2.0 0.7 V <sub>DD</sub>	V <sub>DD</sub> + 0.3 V <sub>DD</sub> + 0.3	V V
Input Low Voltage RES, RDY, IRQ, Data, $\overline{SO}$ , BE ABORT, NMI, $\phi 2$ (IN)	V <sub>IL</sub>	-0.3 -0.3	0.8 0.2	V V
Input Leakage Current (V <sub>IN</sub> = 0 to V <sub>DD</sub> ) RES, NMI, RDY, IRQ, $\overline{SO}$ , BE, ABORT (Internal Pullup) $\phi 2$ (IN) Address, Data, R/W (Off State, BE = 0)	I <sub>IN</sub>	-100 -1 -10	1 1 10	$\mu$ A $\mu$ A $\mu$ A
Output High Voltage (I <sub>OH</sub> = -100 $\mu$ A) SYNC, Data, Address, R/W, ML, VP, M/X, E, VDA, VPA, $\phi 1$ (OUT), $\phi 2$ (OUT)	V <sub>OH</sub>	0.7 V <sub>DD</sub>	—	V
Output Low Voltage (I <sub>OL</sub> = 1.6mA) SYNC, Data, Address, R/W, ML, VP, M/X, E, VDA, VPA, $\phi 1$ (OUT), $\phi 2$ (OUT)	V <sub>OL</sub>	—	0.4	V
Supply Current f = 2 MHz (No Load) f = 4 MHz f = 6 MHz f = 8 MHz	I <sub>DD</sub>	— — — —	10 20 30 40	mA mA mA mA
Standby Current (No Load; Data Bus = V <sub>SS</sub> or V <sub>DD</sub> ; $\phi 2$ (IN) = ABORT = RES = NMI = IRQ = $\overline{SO}$ = BE = V <sub>DD</sub> )	I <sub>SB</sub>	—	10	$\mu$ A
Capacitance (V <sub>IN</sub> = 0V, T <sub>A</sub> = 25°C, f = 2 MHz) Logic, $\phi 2$ (IN) Address, Data, R/W (Off State)	C <sub>IN</sub> C <sub>TS</sub>	— —	10 15	pF pF

### AC Characteristics (G65SC802): V<sub>DD</sub> = 5.0V ±5%, V<sub>SS</sub> = 0V, T<sub>A</sub> = 0°C to +70°C

Parameter	Symbol	2 MHz		4 MHz		6 MHz		8 MHz		Unit
		Min	Max	Min	Max	Min	Max	Min	Max	
Cycle Time	t <sub>CYC</sub>	500	DC	250	DC	167	DC	125	DC	nS
Clock Pulse Width Low	t <sub>PWL</sub>	240	—	120	—	80	—	60	—	nS
Clock Pulse Width High	t <sub>PWH</sub>	240	—	120	—	80	—	60	—	nS
Fall Time, Rise Time	t <sub>F</sub> , t <sub>R</sub>	—	10	—	10	—	5	—	5	nS
Delay Time, $\phi 2$ (IN) to $\phi 1$ (OUT)	t <sub>d<math>\phi 1</math></sub>	—	20	—	20	—	20	—	20	nS
Delay Time, $\phi 2$ (IN) to $\phi 2$ (OUT)	t <sub>d<math>\phi 2</math></sub>	—	40	—	40	—	40	—	40	nS
Address Hold Time	t <sub>AH</sub>	10	—	10	—	10	—	10	—	nS
Address Setup Time	t <sub>ADS</sub>	—	100	—	75	—	60	—	40	nS
Access Time	t <sub>ACC</sub>	365	—	130	—	87	—	70	—	nS
Read Data Hold Time	t <sub>DHR</sub>	10	—	10	—	10	—	10	—	nS
Read Data Setup Time	t <sub>DSR</sub>	—	40	—	30	—	20	—	15	nS
Write Data Delay Time	t <sub>MDS</sub>	—	100	—	70	—	60	—	40	nS
Write Data Hold Time	t <sub>DHW</sub>	10	—	10	—	10	—	10	—	nS
Processor Control Setup Time	t <sub>PCS</sub>	125	—	100	—	75	—	50	—	nS
$\overline{SO}$ Setup Time	t <sub>SO</sub>	50	—	35	—	25	—	20	—	nS
Capacitive Load (Address, Data, and R/W)	C <sub>EXT</sub>	—	100	—	100	—	35	—	35	pF

**AC Characteristics (G65SC816):**  $V_{DD} = 5.0V \pm 5\%$ ,  $V_{SS} = 0V$ ,  $T_A = 0^\circ C$  to  $+70^\circ C$

Parameter	Symbol	2 MHz		4 MHz		6 MHz		8 MHz		Unit
		Min	Max	Min	Max	Min	Max	Min	Max	
Cycle Time	t <sub>cy</sub>	500	DC	250	DC	167	DC	125	DC	nS
Clock Pulse Width Low	t <sub>pwl</sub>	240	—	120	—	80	—	60	—	nS
Clock Pulse Width High	t <sub>pwh</sub>	240	—	120	—	80	—	60	—	nS
Fall Time, Rise Time	t <sub>f</sub> , t <sub>r</sub>	—	10	—	10	—	5	—	5	nS
A0-A15 Hold Time	t <sub>ah</sub>	10	—	10	—	10	—	10	—	nS
A0-A15 Setup Time	t <sub>ads</sub>	—	100	—	75	—	60	—	40	nS
A16-A23 Hold Time	t <sub>bh</sub>	10	—	10	—	10	—	10	—	nS
A16-A23 Setup Time	t <sub>bas</sub>	—	100	—	90	—	65	—	45	nS
Access Time	t <sub>acc</sub>	365	—	130	—	87	—	70	—	nS
Read Data Hold Time	t <sub>dhr</sub>	10	—	10	—	10	—	10	—	nS
Read Data Setup Time	t <sub>dsr</sub>	—	40	—	30	—	20	—	15	nS
Write Data Delay Time	t <sub>m</sub>	—	100	—	70	—	60	—	40	nS
Write Data Hold Time	t <sub>dhw</sub>	10	—	10	—	10	—	10	—	nS
Processor Control Setup Time	t <sub>pcs</sub>	125	—	100	—	75	—	50	—	nS
M/X Output Setup Time	t <sub>xms</sub>	50	—	50	—	25	—	15	—	nS
M/X Output Hold Time	t <sub>xmh</sub>	10	—	10	—	5	—	5	—	nS
E Output Setup Time	t <sub>es</sub>	50	—	50	—	25	—	15	—	nS
Capacitive Load (Address, Data, and R/W)	C <sub>EXT</sub>	—	100	—	100	—	35	—	35	pF
BE to High Impedance State	t <sub>bhz</sub>	—	30	—	30	—	30	—	30	nS
BE to Valid Data	t <sub>bvd</sub>	—	30	—	30	—	30	—	30	nS

**Timing Diagram (G65SC802)**

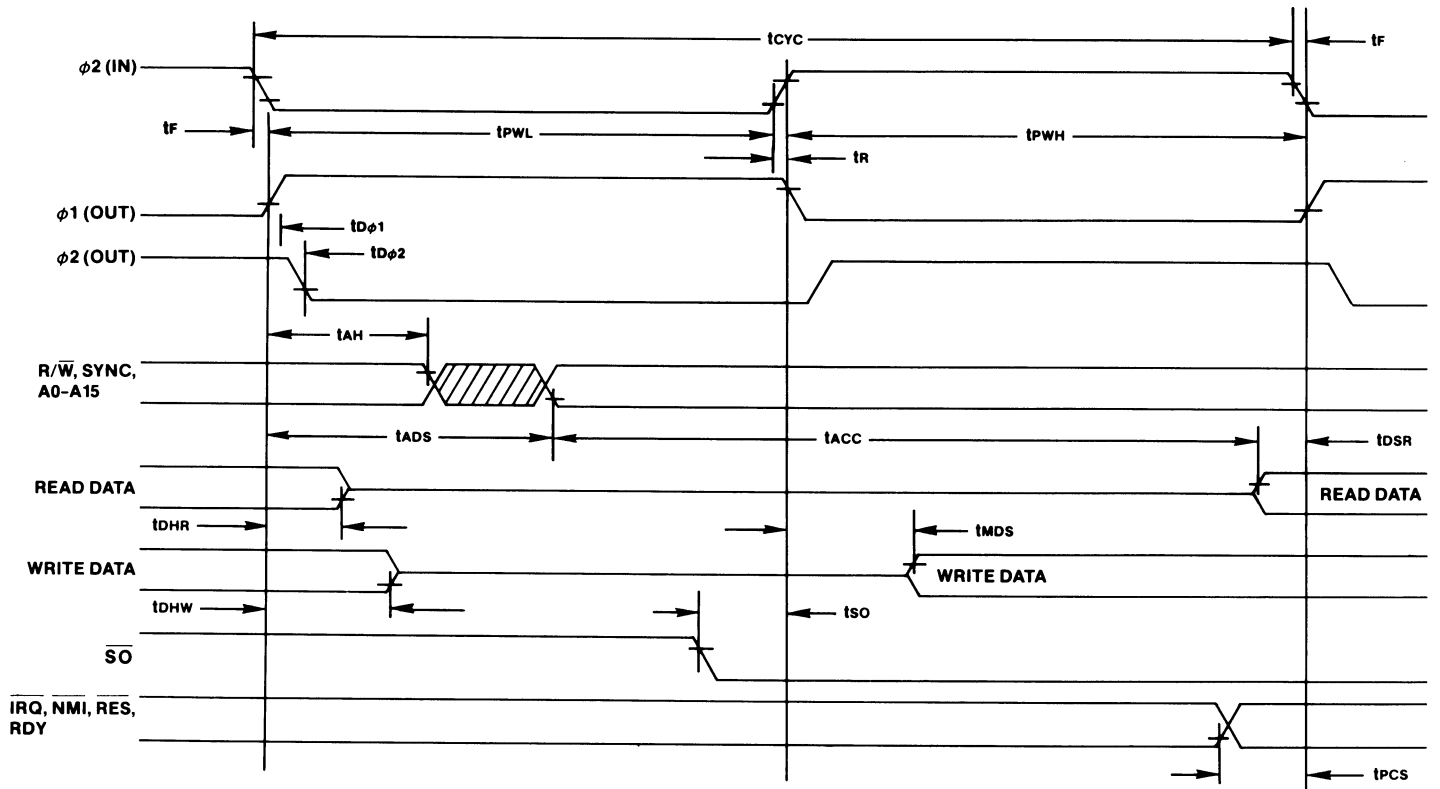

## Timing Diagram (G65SC816)

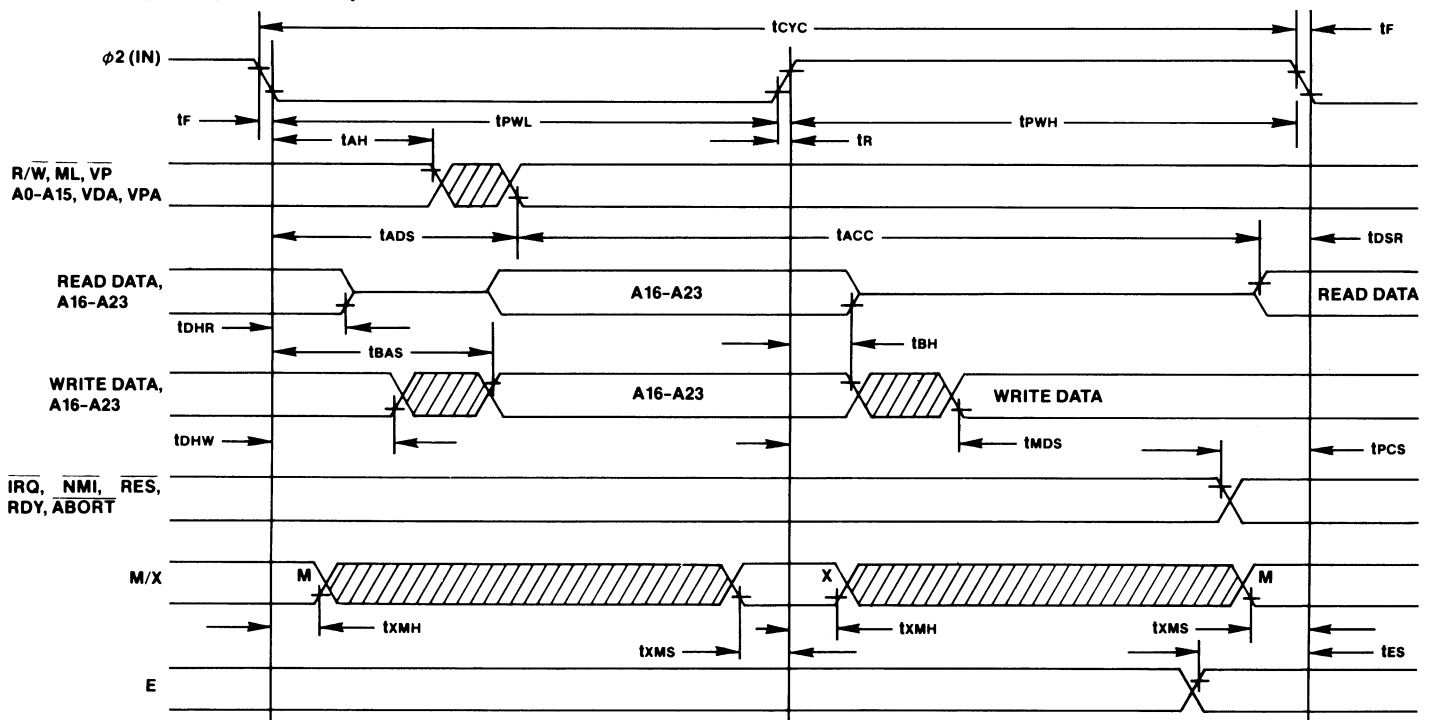

### Timing Notes:

1. Typical output load = 100 pF
2. Voltage levels are  $V_L < 0.4V$ ,  $V_H > 2.4V$
3. Timing measurement points are 0.8V and 2.0V

## Functional Description

The G65SC802 offers the design engineer the opportunity to utilize both existing software programs and hardware configurations, while also achieving the added advantages of increased register lengths and faster execution times. The G65SC802's "ease of use" design and implementation features provide the designer with increased flexibility and reduced implementation costs. In the Emulation mode, the G65SC802 not only offers software compatibility, but is also hardware (pin-to-pin) compatible with 6502 designs... plus it provides the advantages of 16-bit internal operation in 6502-compatible applications. The G65SC802 is an excellent direct replacement microprocessor for 6502 designs.

The G65SC816 provides the design engineer with upward mobility and software compatibility in applications where a 16-bit system configuration is desired. The G65SC816's 16-bit hardware configuration, coupled with current software allows a wide selection of system applications. In the Emulation mode, the G65SC816 offers many advantages, including full software compatibility with 6502 coding. In addition, the G65SC816's powerful instruction set and addressing modes make it an excellent choice for new 16-bit designs.

Internal organization of the G65SC802 and G65SC816 can be divided into two parts: 1) The Register Section, and 2) The Control Section. Instructions (or opcodes) obtained from program memory are executed by implementing a series of data transfers within the Register Section. Signals that cause data transfers to be executed are generated within the Control Section. Both the G65SC802 and the G65SC816 have a 16-bit internal architecture with an 8-bit external data bus.

### Instruction Register and Decode

An opcode enters the processor on the Data Bus, and is latched into the Instruction Register during the instruction fetch cycle. This instruction is then decoded, along with timing and interrupt signals, to generate the various Instruction Register control signals.

### Timing Control Unit (TCU)

The Timing Control Unit keeps track of each instruction cycle as it is ex-

ecuted. The TCU is set to zero each time an instruction fetch is executed, and is advanced at the beginning of each cycle for as many cycles as is required to complete the instruction. Each data transfer between registers depends upon decoding the contents of both the Instruction Register and the Timing Control Unit.

### Arithmetic and Logic Unit (ALU)

All arithmetic and logic operations take place within the 16-bit ALU. In addition to data operations, the ALU also calculates the effective address for relative and indexed addressing modes. The result of a data operation is stored in either memory or an internal register. Carry, Negative, Overflow and Zero flags may be updated following the ALU data operation.

### Internal Registers (Refer to Figure 2, Programming Model)

#### Accumulator (A)

The Accumulator is a general purpose register which stores one of the operands, or the result of most arithmetic and logical operations. In the Native mode ( $E=0$ ), when the Accumulator Select Bit (M) equals zero, the Accumulator is established as 16 bits wide. When the Accumulator Select Bit (M) equals one, the Accumulator is 8 bits wide. In this case, the upper 8 bits (AH) may be used for temporary storage in conjunction with the Swap Accumulator (SWA) instruction.

#### Data Bank (DB)

During the Native mode ( $E=0$ ), the 8-bit Data Bank Register holds the default bank address for memory transfers. The 24-bit address is composed of the 16-bit instruction effective address and the 8-bit Data Bank address. The register value is multiplexed with the data value and is present on the Data/Address lines during the first half of a data transfer memory cycle for the G65SC816. The Data Bank Register is initialized to zero during Reset.

#### Direct (D)

The 16-bit Direct Register provides an address offset for all instructions using direct addressing. The effective bank zero address is formed by adding the 8-bit instruction operand address to the Direct Register. The Direct Register is initialized to zero during Reset.

### Index (X and Y)

There are two Index Registers (X and Y) which may be used as general purpose registers or to provide an index value for calculation of the effective address. When executing an instruction with indexed addressing, the microprocessor fetches the opcode and the base address, and then modifies the address by adding the Index Register contents to the address prior to performing the desired operation. Pre-indexing or post-indexing of indirect addresses may be selected. In the Native mode (E=0), both Index Registers are 16 bits wide (providing the Index Select Bit (X) equals zero). If the Index Select Bit (X) equals one, both registers will be 8 bits wide.

### Processor Status (P)

The 8-bit Processor Status Register contains status flags and mode select bits. The Carry (C), Negative (N), Overflow (V), and Zero (Z) status flags serve to report the status of most ALU operations. These status flags are tested by use of Conditional Branch instructions. The Decimal (D), IRQ Disable (I), Memory/Accumulator (M), and Index (X) bits are used as mode select flags. These flags are set by the program to change microprocessor operations.

The Emulation (E) select and the Break (B) flags are accessible only through the Processor Status Register. The Emulation mode select flag is selected by the Exchange Carry and Emulation Bits (XCE) instruction. Table 2, G65SC802 and G65SC816 Mode Comparison, illustrates the features of the Native (E=0) and Emulation (E=1) modes. The M and X

flags are always equal to one in the Emulation mode. When an interrupt occurs during the Emulation mode, the Break flag is written to stack memory as bit 4 of the Processor Status Register.

### Program Bank (PB)

The 8-bit Program Bank Register holds the bank address for all instruction fetches. The 24-bit address consists of the 16-bit instruction effective address and the 8-bit Program Bank address. The register value is multiplexed with the data value and presented on the Data/Address lines during the first half of a program memory read cycle. The Program Bank Register is initialized to zero during Reset.

### Program Counter (PC)

The 16-bit Program Counter Register provides the addresses which are used to step the microprocessor through sequential program instructions. The register is incremented each time an instruction or operand is fetched from program memory.

### Stack Pointer (S)

The Stack Pointer is a 16-bit register which is used to indicate the next available location in the stack memory area. It serves as the effective address in stack addressing modes as well as subroutine and interrupt processing. The Stack Pointer allows simple implementation of nested subroutines and multiple-level interrupts. During the Emulation mode, the Stack Pointer high-order byte (SH) is always equal to one.

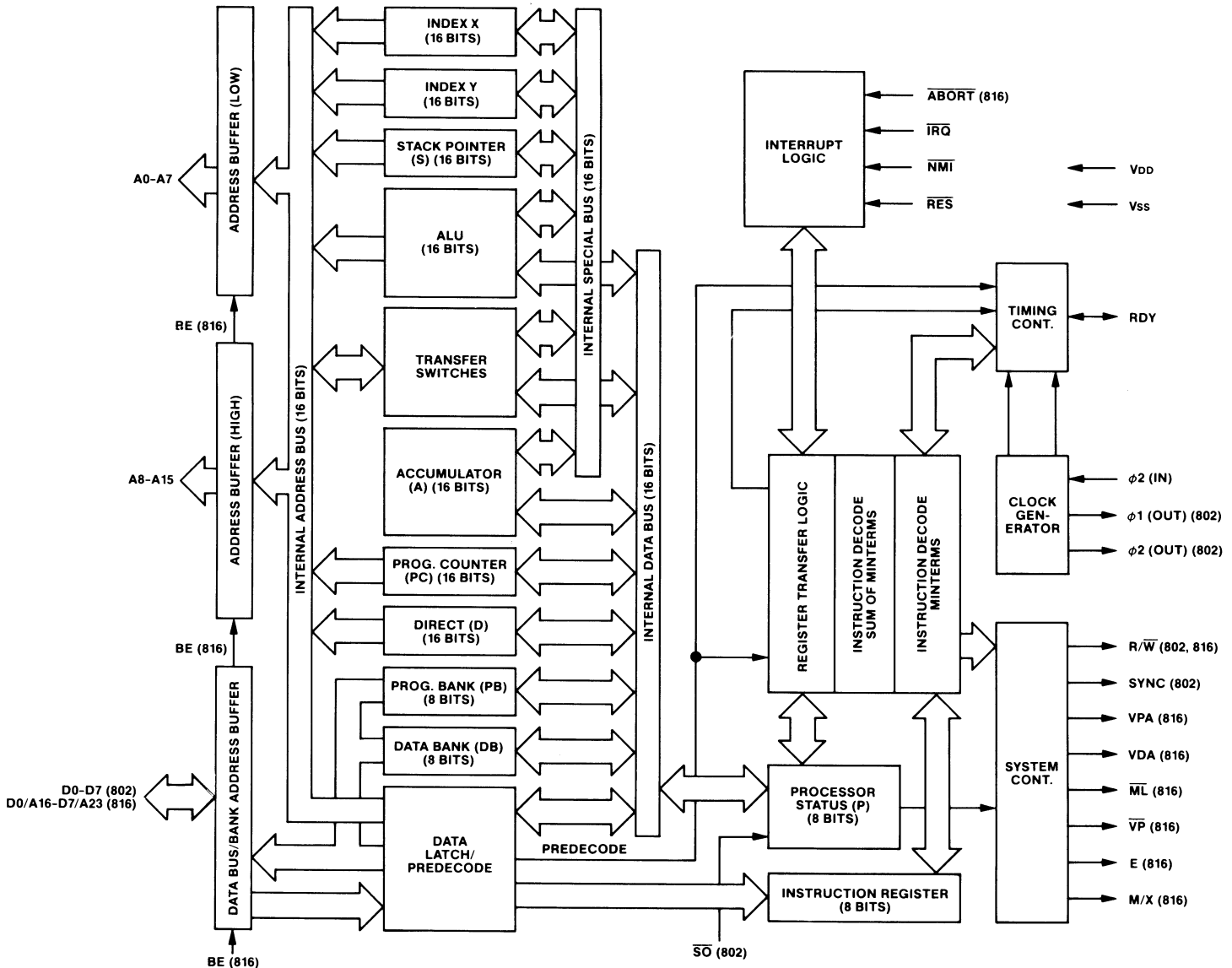

Figure 1. Block Diagram — Internal Architecture

## Signal Description

The following Signal Description applies to both the G65SC802 and the G65SC816 except as otherwise noted.

### Abort (ABORT)—G65SC816

The Abort input is used to abort instructions (usually due to an Address Bus condition). A negative transition will inhibit modification of any internal register during the current instruction. Upon completion of this instruction, an interrupt sequence is initiated. The location of the aborted opcode is stored as the return address in stack memory. The Abort vector address is 00FFF8,9 (Emulation mode) or 00FFE8,9 (Native mode). Since ABORT is an edge-sensitive input, an Abort will occur whenever there is a negative transition on the ABORT line.

### Address Bus (A0-A15)

These sixteen output lines form the Address Bus for memory and I/O exchange on the Data Bus. When using the G65SC816, the address lines may be set to the high impedance state by the Bus Enable (BE) signal.

### Bus Enable (BE)

The Bus Enable input signal allows external control of the Address and Data Buffers, as well as the R/W signal. With Bus Enable high, the R/W and Address Buffers are active. The Data/Address Buffers are active during the first half of every cycle and the second half of a write cycle. When BE is low, these buffers are disabled. Bus Enable is an asynchronous signal.

### Data Bus (D0-D7)—G65SC802

The eight Data Bus lines provide an 8-bit bidirectional Data Bus for use during data exchanges between the microprocessor and external memory or peripherals. Two memory cycles are required for the transfer of 16-bit values.

### Data/Address Bus (D0/A16-D7/A23)—G65SC816

These eight lines multiplex address bits A16-A23 with the data value. The address is present during the first half of a memory cycle, and the data value is read or written during the second half of the memory cycle. Two memory cycles are required to transfer 16-bit values. These lines may be set to the high impedance state by the Bus Enable (BE) signal.

### Emulation Status (E)—G65SC816

The Emulation Status output reflects the state of the Emulation (E) mode flag in the Processor Status (P) Register. This signal may be thought of as an opcode extension and used for memory and system management.

### Interrupt Request (IRQ)

The Interrupt Request input signal is used to request that an interrupt sequence be initiated. When the IRQ Disable (I) flag is cleared, a low input logic level initiates an interrupt sequence after the current instruction is completed. The Wait for Interrupt (WAI) instruction may be executed to ensure the interrupt will be recognized immediately. The Interrupt Request vector address is 00FFFE,F (Emulation mode) or 00FEE,F (Native mode). Since IRQ is a level-sensitive input, an interrupt will occur if the interrupt source was not cleared since the last interrupt. Also, no interrupt will occur if the interrupt source is cleared prior to interrupt recognition.

### Memory Lock (ML)—G65SC816

The Memory Lock output may be used to ensure the integrity of Read-Modify-Write instructions in a multiprocessor system. Memory Lock indicates the need to defer arbitration of the next bus cycle. Memory Lock is low during the last three or five cycles of ASL, DEC, INC, LSR, ROL, ROR, TRB, and TSB memory referencing instructions, depending on the state of the M flag.

### Memory/Index Select Status (M/X)—G65SC816

This multiplexed output reflects the state of the Accumulator (M) and Index (X) select flags (bits 5 and 4 of the Processor Status (P) Register. Flag M is valid during the Phase 2 clock negative transition and Flag X is valid during the Phase 2 clock positive transition. These bits may be thought of as opcode extensions and may be used for memory and system management.

### Non-Maskable Interrupt (NMI)

A negative transition on the NMI input initiates an interrupt sequence. A high-to-low transition initiates an interrupt sequence after the current instruction is completed. The Wait for Interrupt (WAI) instruction may be executed to ensure that the interrupt will be recognized immediately. The Non-Maskable Interrupt vector address is 00FFFA,B (Emulation mode) or 00FFEA,B (Native mode). Since NMI is an edge-sensitive input, an interrupt will occur if there is a negative transition while servicing a previous interrupt. Also, no interrupt will occur if NMI remains low.

### Phase 1 Out ( $\phi 1$ (OUT))—G65SC802

This inverted clock output signal provides timing for external read and write operations. Executing the Stop (STP) instruction holds this clock in the low state.

### Phase 2 In ( $\phi 2$ (IN))

This is the system clock input to the microprocessor internal clock generator (equivalent to  $\phi 0$  (IN) on the 6502). During the low power Standby Mode,  $\phi 2$  (IN) should be held in the high state to preserve the contents of internal registers.

### Phase 2 Out ( $\phi 2$ (OUT))—G65SC802

This clock output signal provides timing for external read and write operations. Addresses are valid (after the Address Setup Time ( $T_{ADs}$ )) following the negative transition of Phase 2 Out. Executing the Stop (STP) instruction holds Phase 2 Out in the High state.

### Read/Write (R/W)

When the R/W output signal is in the high state, the microprocessor is reading data from memory or I/O. When in the low state, the Data Bus contains valid data from the microprocessor which is to be stored at the addressed memory location. When using the G65SC816, the R/W signal may be set to the high impedance state by Bus Enable (BE).

### Ready (RDY)

This bidirectional signal indicates that a Wait for Interrupt (WAI) instruction has been executed allowing the user to halt operation of the microprocessor. A low input logic level will halt the microprocessor in its current state (note that when in the Emulation mode, the G65SC802 stops only during a read cycle). Returning RDY to the active high state allows the microprocessor to continue following the next Phase 2 In Clock negative transition. The RDY signal is internally pulled low following the execution of a Wait for Interrupt (WAI) instruction, and then returned to the high state when a RES, ABORT, NMI, or IRQ external interrupt is provided. This feature may be used to eliminate interrupt latency by placing the WAI instruction at the beginning of the IRQ servicing routine. If the IRQ Disable flag has been set, the next instruction will be executed when the IRQ occurs. The processor will not stop after a WAI instruction if RDY has been forced to a high state. The Stop (STP) instruction has no effect on RDY.

### Reset (RES)

The Reset input is used to initialize the microprocessor and start program execution. The Reset input buffer has hysteresis such that a simple R-C timing circuit may be used with the internal pullup device. The RES signal must be held low for at least two clock cycles after  $V_{DD}$  reaches operating voltage. Ready (RDY) has no effect while RES is being held low. During this Reset conditioning period, the following processor initialization takes place:

#### Registers

D	=	0000	SH	=	01
DB	=	00	XH	=	00
PB	=	00	YH	=	00

		N	V	M	X	D	I	Z	C/E	
P	=	*	*	1	1	0	1	*	*/1	* = Not Initialized

STP and WAI instructions are cleared.

#### Signals

E	=	1	VDA	=	0
M/X	=	1	VP	=	1
R/W	=	1	VPA	=	0
SYNC	=	0			

- When Reset is brought high, an interrupt sequence is initiated:
- R/W remains in the high state during the stack address cycles.
- The Reset vector address is 00FFFC,D.

### Set Overflow (SO)—G65SC802

A negative transition on this input sets the Overflow (V) flag, bit 6 of the Processor Status (P) Register.

### Synchronize (SYNC)—G65SC802

The SYNC output is provided to identify those cycles during which the microprocessor is fetching an opcode. The SYNC signal is high during an opcode fetch cycle, and when combined with Ready (RDY), can be used for single instruction execution.

### Valid Data Address (VDA) and

### Valid Program Address (VPA)—G65SC816

These two output signals indicate the type of memory being accessed by the address bus. The following coding applies:

#### VDA VPA

0	0	Internal Operation—Address and Data Bus available.
0	1	Valid program address—may be used for program cache control.
1	0	Valid data address—may be used for data cache control.
1	1	Opcode fetch—may be used for program cache control and single step control.

### VDD and VSS

VDD is the positive supply voltage and VSS is system logic ground. Either of the two VSS pins on the G65SC802 may be used for system ground.

### Vector Pull ( $\overline{VP}$ )—G65SC816

The Vector Pull output indicates that a vector location is being addressed during an interrupt sequence.  $\overline{VP}$  is low during the last two interrupt sequence cycles, during which time the processor reads the interrupt vector. The  $\overline{VP}$  signal may be used to select and prioritize interrupts from several sources by modifying the vector addresses.

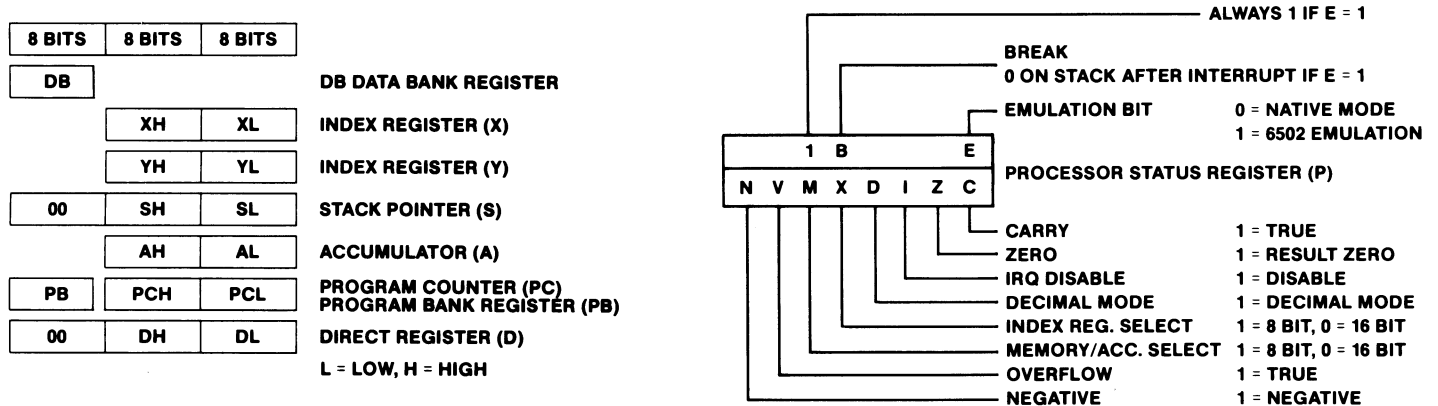

Figure 2. Programming Model

Table 1. G65SC802 and G65SC816 Compatibility

Function	G65SC802/816 Emulation	G65SC02	NMOS 6502
Decimal Mode: <ul style="list-style-type: none"> <li>After Interrupts</li> <li>N, Z Flags</li> <li>ADC, SBC</li> </ul>	0 → D Valid No added cycle	0 → D Valid Add 1 cycle	Not initialized Undefined No added cycle
Read-Modify-Write: <ul style="list-style-type: none"> <li>Absolute Indexed, No Page Crossing</li> <li>Write</li> <li>Memory Lock</li> </ul>	7 cycles Last 2 cycles Last 3 cycles	6 cycles Last cycle Last 2 cycles	7 cycles Last 2 cycles Not available
Jump Indirect: <ul style="list-style-type: none"> <li>Cycles</li> <li>Jump Address, Operand = XXFF</li> </ul>	5 cycles Correct	6 cycles Correct	5 cycles Invalid
Branch or Index Across Page Boundary	Read last program byte	Read last program byte	Read invalid address
0 → RDY During Write	G65SC802: Ignored until read G65SC816: Processor stops	Processor stops	Ignored until read
Write During Reset	No	Yes	No
Unused Opcodes	No operation	No operation	Undefined
$\phi 1$ (OUT), $\phi 2$ (OUT), $\overline{SO}$ , SYNC Signals	Available with G65SC802 only	Available	Available
RDY Signal	Bidirectional	Input	Input

**Table 2. G65SC802 and G65SC816 Mode Comparison**

Function	Emulation (E = 1)	Native (E = 0)
Stack Pointer (S)	8 bits in page 1	16 bits
Direct Index Address	Wrap within page	Crosses page boundary
Processor Status (P): • Bit 4	Always one, except zero in stack after hardware interrupt	X flag (8/16-bit Index)
• Bit 5	Always one	M flag (8/16-bit Accumulator)
Branch Across Page Boundary	4 cycles	3 cycles
Vector Locations: ABORT BRK COP IRQ NMI RES	00FFF8,9 00FFFE,F 00FFF4,5 00FFFE,F 00FFFA,B 00FFFC,D	00FFE8,9 00FFE6,7 00FE4,5 00FEE,F 00FEEA,B 00FFFC,D (1 → E)
Program Bank (PB) During Interrupt, RTI	Not pushed, pulled	Pushed and pulled
0 – RDY During Write	G65SC802: Ignored until read G65SC816: Processor stops	Processor stops
Write During Read-Modify-Write	Last 2 cycles	Last 1 or 2 cycles depending on M flag

**G65SC802 and G65SC816  
Microprocessor Addressing Modes**

The G65SC816 is capable of directly addressing 16 MBytes of memory. This address space has special significance within certain addressing modes, as follows:

**Reset and Interrupt Vectors**

The Reset and Interrupt vectors use the majority of the fixed addresses between 00FFE0 and 00FFFF.

**Stack**

The Stack may use memory from 000000 to 00FFFF. The effective address of Stack and Stack Relative addressing modes will always be within this range.

**Direct**

The Direct addressing modes are usually used to store memory registers and pointers. The effective address generated by Direct, Direct,X and Direct,Y addressing modes is always in Bank 0 (000000-00FFFF).

**Program Address Space**

The Program Bank register is not affected by the Relative, Relative Long, Absolute, Absolute Indirect, and Absolute Indexed Indirect addressing modes or by incrementing the Program Counter from FFFF. The only instructions that affect the Program Bank register are: RTI, RTL, JML, JSL, and JMP Absolute Long. Program code may exceed 64K bytes although code segments may not span bank boundaries.

**Data Address Space**

The data address space is contiguous throughout the 16 MByte address space. Words, arrays, records, or any data structures may span 64 KByte bank boundaries with no compromise in code efficiency. The following addressing modes generate 24-bit effective addresses:

- Direct Indexed Indirect (d,x)
- Direct Indirect Indexed (d),y
- Direct Indirect (d)
- Direct Indirect Long [d]
- Direct Indirect Indexed Long [d],y
- Absolute
- Absolute,x
- Absolute,y
- Absolute long
- Absolute long indexed
- Stack Relative Indirect Indexed (r,s),y

The following addressing mode descriptions provide additional detail as to how effective addresses are calculated.

Twenty-four addressing modes are available for use with the G65SC802 and G65SC816 microprocessors. The "long" addressing modes may be used with the G65SC802; however, the high byte of the address is not available to the hardware. Detailed descriptions of the 24 addressing modes are as follows:

**1. Immediate Addressing—#**

The operand is the second byte (second and third bytes when in the 16-bit mode) of the instruction.

**2. Absolute—a**

With Absolute addressing the second and third bytes of the instruction form the low-order 16 bits of the effective address. The Data Bank Register contains the high-order 8 bits of the operand address.

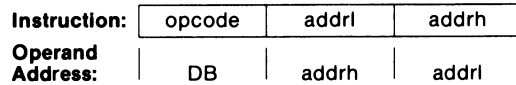

**3. Absolute Long—al**

The second, third, and fourth byte of the instruction form the 24-bit effective address.

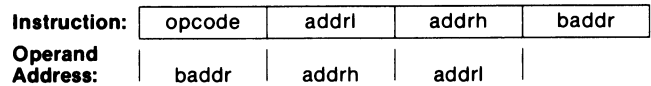

**4. Direct—d**

The second byte of the instruction is added to the Direct Register (D) to form the effective address. An additional cycle is required when the Direct Register is not page aligned (DL not equal 0). The Bank register is always 0.

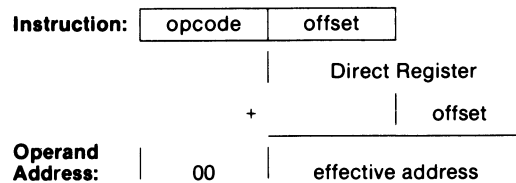

**5. Accumulator—A**

This form of addressing always uses a single byte instruction. The operand is the Accumulator.



### 6. Implied—

Implied addressing uses a single byte instruction. The operand is implicitly defined by the instruction.

### 7. Direct Indirect Indexed—(d),y

This address mode is often referred to as Indirect,Y. The second byte of the instruction is added to the Direct Register (D). The 16-bit contents of this memory location is then combined with the Data Bank register to form a 24-bit base address. The Y Index Register is added to the base address to form the effective address.

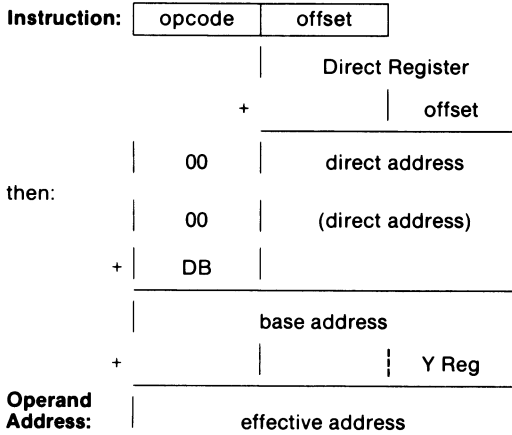

### 8. Direct Indirect Indexed Long—[d],y

With this addressing mode, the 24-bit base address is pointed to by the sum of the second byte of the instruction and the Direct Register. The effective address is this 24-bit base address plus the Y Index Register.

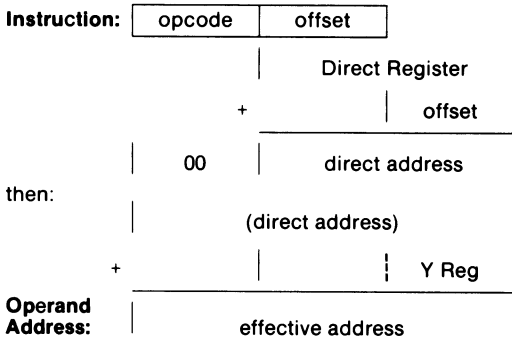

### 9. Direct Indexed Indirect—(d,x)

This address mode is often referred to as Indirect,X. The second byte of the instruction is added to the sum of the Direct Register and the X Index Register. The result points to the low-order 16 bits of the effective address. The Data Bank Register contains the high-order 8 bits of the effective address.

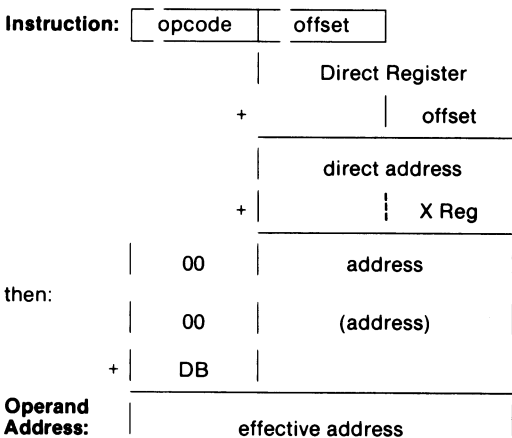

### 10. Direct Indexed With X—d,x

The second byte of the instruction is added to the sum of the Direct Register and the X Index Register to form the 16-bit effective address. The operand is always in Bank 0.

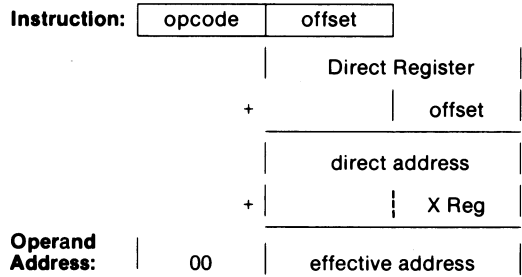

### 11. Direct Indexed With Y—d,y

The second byte of the instruction is added to the sum of the Direct Register and the Y Index Register to form the 16-bit effective address. The operand is always in Bank 0.

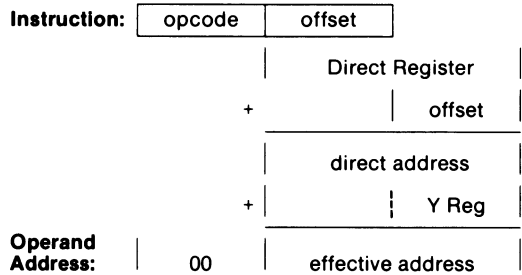

### 12. Absolute Indexed With X—a,x

The second and third bytes of the instruction are added to the X Index Register to form the low-order 16 bits of the effective address. The Data Bank Register contains the high-order 8 bits of the effective address.

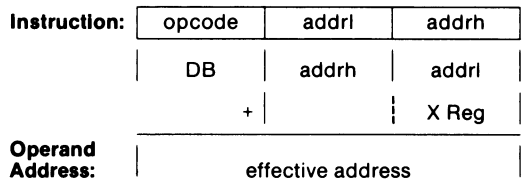

### 13. Absolute Indexed With Y—a,y

The second and third bytes of the instruction are added to the Y Index Register to form the low-order 16 bits of the effective address. The Data Bank Register contains the high-order 8 bits of the effective address.

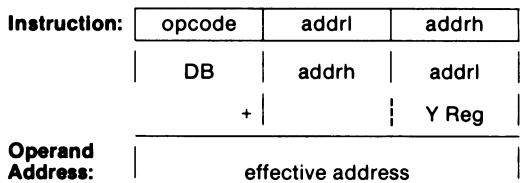

### 14. Absolute Long Indexed With X—a,l,x

The second, third and fourth bytes of the instruction form a 24-bit base address. The effective address is the sum of this 24-bit address and the X Index Register.

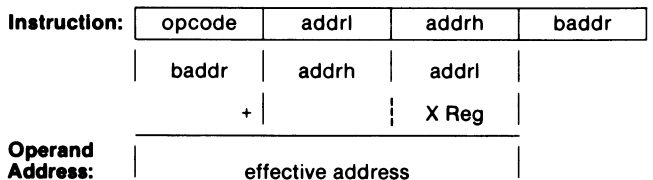

### 15. Program Counter Relative—r

This address mode, referred to as Relative Addressing, is used only with the Branch instructions. If the condition being tested is met, the second byte of the instruction is added to the Program Counter, which has been updated to point to the opcode of the next instruction. The offset is a signed 8-bit quantity in the range from -128 to 127. The Program Bank Register is not affected.

### 16. Program Counter Relative Long—rl

This address mode, referred to as Relative Long Addressing, is used only with the Unconditional Branch Long instruction (BRL) and the Push Effective Relative instruction (PER). The second and third bytes of the instruction are added to the Program Counter, which has been updated to point to the opcode of the next instruction. With the branch instruction, the Program Counter is loaded with the result. With the Push Effective Relative instruction, the result is stored on the stack. The offset is a signed 16-bit quantity in the range from -32768 to 32767. The Program Bank Register is not affected.

### 17. Absolute Indirect—(a)

The second and third bytes of the instruction form an address to a pointer in Bank 0. The Program Counter is loaded with the first and second bytes at this pointer. With the Jump Long (JML) instruction, the Program Bank Register is loaded with the third byte of the pointer.

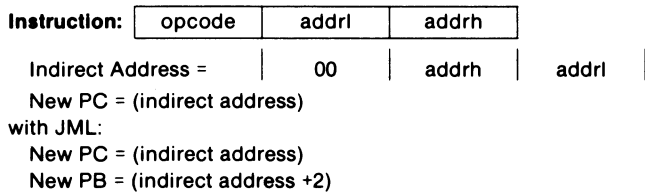

### 18. Direct Indirect—(d)

The second byte of the instruction is added to the Direct Register to form a pointer to the low-order 16 bits of the effective address. The Data Bank Register contains the high-order 8 bits of the effective address.

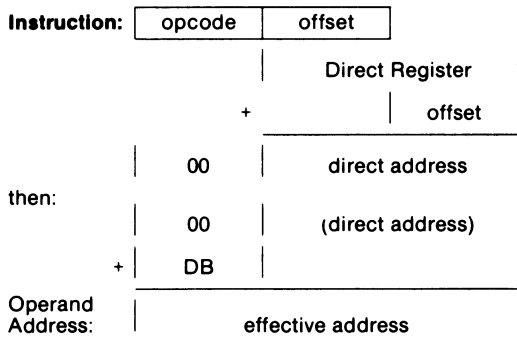

### 19. Direct Indirect Long—[d]

The second byte of the instruction is added to the Direct Register to form a pointer to the 24-bit effective address.

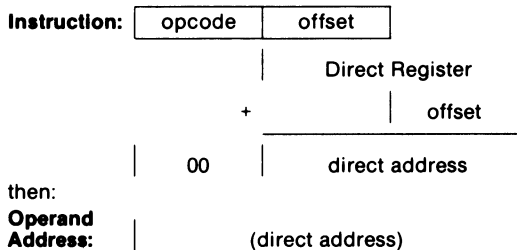

### 20. Absolute Indexed Indirect—(a,x)

The second and third bytes of the instruction are added to the X Index Register to form a 16-bit pointer in Bank 0. The contents of this pointer are loaded in the Program Counter. The Program Bank Register is not changed.

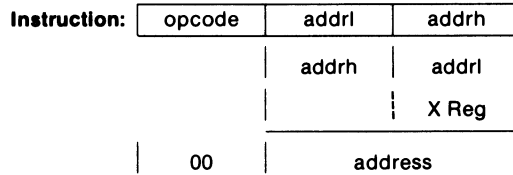

then:

$$PC = (\text{address})$$

### 21. Stack

Stack addressing refers to all instructions that push or pull data from the stack, such as Push, Pull, Jump to Subroutine, Return from Subroutine, Interrupts, and Return from Interrupt. The bank address is always 0. Interrupt Vectors are always fetched from Bank 0.

### 22. Stack Relative—r,s

The low-order 16 bits of the effective address is formed from the sum of the second byte of the instruction and the Stack Pointer. The high-order 8 bits of the effective address is always zero. The relative offset is an unsigned 8-bit quantity in the range of 0 to 255.

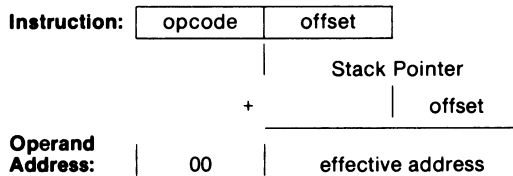

### 23. Stack Relative Indirect Indexed—(r,s),y

The second byte of the instruction is added to the Stack Pointer to form a pointer to the low-order 16-bit base address in Bank 0. The Data Bank Register contains the high-order 8 bits of the base address. The effective address is the sum of the 24-bit base address and the Y Index Register.

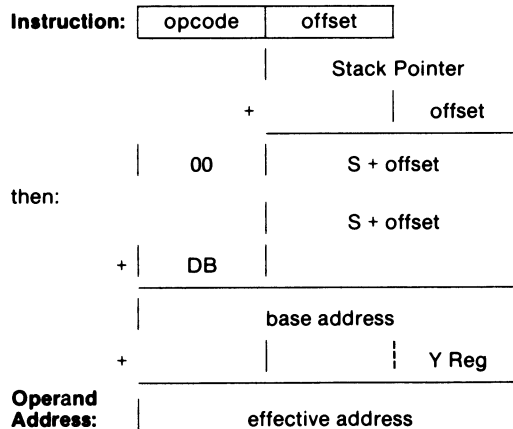

### 24. Block

This addressing mode is used by the Block Move instructions. The second byte of the instruction contains the high-order 8 bits of the destination address. The Y index Register contains the low-order 16 bits of the destination address. The third byte of the instruction contains the high-order 8 bits of the source address. The X Index Register contains the low-order 16 bits of the source address. The Accumulator contains one less than the number of bytes to move. The second byte of the block move instructions is also loaded into the Data Bank Register.

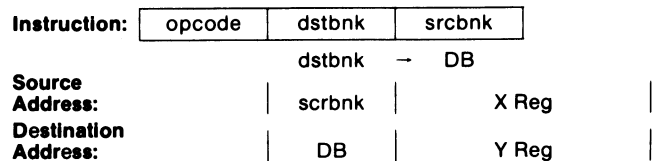

Increment (MVN) or decrement (MVP) X and Y.  
Decrement A, (if positive), then PC-3 - PC.

## Interrupt Processing Sequence

The interrupt processing sequence is initiated as the direct result of hardware Abort, Interrupt Request, Non-Maskable Interrupt, or Reset inputs.

The interrupt sequence can also be initiated as a result of the Break or Co-Processor instructions within the software. The following listings describe the function of each cycle in the interrupt processing sequence:

### Hardware Interrupt— $\overline{\text{ABORT}}$ , $\overline{\text{IRQ}}$ , $\overline{\text{NMI}}$ , $\overline{\text{RES}}$ Inputs

Cycle No.		Address	Data	R/W	SYNC	VDA	VPA	VP	Description
E = 0	E = 1								
1	1	PC	X	1	1	1	1	1	Internal Operation
2	2	PC	X	1	0	0	0	1	Internal Operation
3	[1]	S	PB	0	0	1	0	1	Write PB to Stack, S-1 → S
4	3	S	PCH [2]	0 [3]	0	1	0	1	Write PCH to Stack, S-1 → S
5	4	S	PCL [2]	0 [3]	0	1	0	1	Write PCL to Stack, S-1 → S
6	5	S	P [4]	0 [3]	0	1	0	1	Write P to Stack, S-1 → S
7	6	VL	(VL)	1	0	1	0	0	Read Vector Low Byte, P: 0 → D, 1 → I
8	7	VH	(VH)	1	0	1	0	0	Read Vector High Byte

### Software Interrupt—BRK, COP Instructions

Cycle No.		Address	Data	R/W	SYNC	VDA	VPA	VP	Description
E = 0	E = 1								
1	1	PC-2	X	1	1	1	1	1	Opcode
2	2	PC-1	X	1	0	0	1	1	Signature
3	[1]	S	PB	0	0	1	0	1	Write PB to Stack, S-1 → S
4	3	S	PCH	0	0	1	0	1	Write PCH to Stack, S-1 → S
5	4	S	PCL	0	0	1	0	1	Write PCL to Stack, S-1 → S
6	5	S	P	0	0	1	0	1	Write P to Stack, S-1 → S
7	6	VL	(VL)	1	0	1	0	0	Read Vector Low Byte, P: 0 → D, 1 → I
8	7	VH	(VH)	1	0	1	0	0	Read Vector High Byte

Notes:

- [1] Delete this cycle in Emulation mode.
- [2] Abort writes address of aborted opcode.
- [3] R/W remains in the high state during Reset.
- [4] In Emulation mode, bit 4 written to stack is changed to 0.

Table 3. Vector Locations

Name	Source	Emulation (E = 1)	Native (E = 0)
$\overline{\text{ABORT}}$	Hardware	00FFF8,9	00FFE8,9
BRK	Software	00FFE6,F	00FFE6,7
COP	Software	00FFF4,5	00FFE4,5
$\overline{\text{IRQ}}$	Hardware	00FFE6,F	00FEE6,F
$\overline{\text{NMI}}$	Hardware	00FFFA,B	00FEEA,B
RESET	Hardware	00FFFC,D	00FFFC,D (1 → E)

**Table 4. G65SC802 and G65SC816 Instruction Set—Alphabetical Sequence**

ADC	Add Memory to Accumulator with Carry	PHA	Push Accumulator on Stack
AND	"AND" Memory with Accumulator	PHB	Push Data Bank Register on Stack
ASL	Shift One Bit Left, Memory or Accumulator	PHD	Push Direct Register on Stack
BCC*	Branch on Carry Clear (Pc = 0)	PHK	Push Program Bank Register on Stack
BCS*	Branch on Carry Set (Pc = 1)	PHP	Push Processor Status on Stack
BEQ	Branch if Equal (Pz = 1)	PHX	Push Index X on Stack
BIT	Bit Test	PHY	Push Index Y on Stack
BMI	Branch if Result Minus (Pn = 1)	PLA	Pull Accumulator from Stack
BNE	Branch if Not Equal (Pz = 0)	PLB	Pull Data Bank Register from Stack
BPL	Branch if Result Plus (Pn = 0)	PLD	Pull Direct Register from Stack
BRA	Branch Always	PLP	Pull Processor Status from Stack
BRK	Force Break	PLX	Pull Index X from Stack
BRL	Branch Always Long	PLY	Pull Index Y from Stack
BVC	Branch on Overflow Clear (Pv = 0)	REP	Reset Status Bits
BVS	Branch on Overflow Set (Pv = 1)	ROL	Rotate One Bit Left (Memory or Accumulator)
CLC	Clear Carry Flag	ROR	Rotate One Bit Right (Memory or Accumulator)
CLD	Clear Decimal Mode	RTI	Return from Interrupt
CLI	Clear Interrupt Disable Bit	RTL	Return from Subroutine Long
CLV	Clear Overflow Flag	RTS	Return from Subroutine
CMP*	Compare Memory and Accumulator	SBC	Subtract Memory from Accumulator with Borrow
COP	Coprocessor	SEC	Set Carry Flag
CPX	Compare Memory and Index X	SED	Set Decimal Mode
CPY	Compare Memory and Index Y	SEI	Set Interrupt Disable Status
DEC*	Decrement Memory or Accumulator by One	SEP	Set Processor Status Bite
DEX	Decrement Index X by One	STA	Store Accumulator in Memory
DEY	Decrement Index Y by One	STP	Stop the Clock
EOR	"Exclusive OR" Memory with Accumulator	STX	Store Index X in Memory
INC*	Increment Memory or Accumulator by One	STY	Store Index Y in Memory
INX	Increment Index X by One	STZ	Store Zero in Memory
INY	Increment Index Y by One	TAX	Transfer Accumulator to Index X
JML**	Jump Long	TAY	Transfer Accumulator to Index Y
JMP	Jump to New Location	TCD*	Transfer Accumulator to Direct Register
JSL**	Jump Subroutine Long	TCS*	Transfer Accumulator to Stack Pointer Register
JSR	Jump to New Location Saving Return Address	TDC*	Transfer Direct Register to Accumulator
LDA	Load Accumulator with Memory	TRB	Test and Reset Bit
LDX	Load Index X with Memory	TSB	Test and Set Bit
LDY	Load Index Y with Memory	TSC*	Transfer Stack Pointer Register to Accumulator
LSR	Shift One Bit Right (Memory or Accumulator)	TSX	Transfer Stack Pointer Register to Index X
MVN	Block Move Negative	TXA	Transfer Index X to Accumulator
MVP	Block Move Positive	TXS	Transfer Index X to Stack Pointer Register
NOP	No Operation	TXY	Transfer Index X to Index Y
ORA	"OR" Memory with Accumulator	TYA	Transfer Index Y to Accumulator
PEA	Push Effective Absolute Address on Stack (or Push Immediate Data on Stack)	TYX	Transfer Index Y to Index X
PEI	Push Effective Indirect Address on Stack (add one cycle if DL ≠ 0)	WAI	Wait for Interrupt
PER	Push Effective Program Counter Relative Address on Stack	XBA*	Exchange B and A Accumulator
		XCE	Exchange Carry and Emulation Bits

**\*Common Mnemonic Aliases**

Mnemonic	Alias
BCC	BLT
BCS	BGE
CMP	CPA
DEC A	DEA
INC A	INA
TCD	TAD
TCS	TAS
TDC	TDA
TSC	TSA
XBA	SWA

\*\*JSL should be recognized as equivalent to JSR when it is specified with long absolute addresses. JML is equivalent to JMP with long addressing forced.

Table 5. Arithmetic and Logical Instructions

Addressing Mode

MNE-MONIC	M/X	OPERATION		Immed	accum	dir	dir,x	dir,y	(dir)	(dir,x)	(dir),y	[dir]	[dir],y	abs	abs,x	abs,y	abs1	abs1,x	r,s	(r,s),y	STATUS								MNEMONIC
		E=1 or E=0 and M/X=1	E=0 and M/X=0																		N	V	M	X	D	I	Z	C	
ADC	Pm	AL+B+Pc→AL	A+W+Pc→A	69		65	75		72	61	71	67	77	6D	7D	79	6F	7F	63	73	N	V	.	.	.	.	Z	C	ADC
AND	Pm	ALΛB→AL	AΛW→A	29		25	35		32	21	31	27	37	2D	3D	39	2F	3F	23	33	N	.	.	.	.	Z	.	AND	
ASL (2)	Pm	Pc→B→0	Pc→W→0		0A	06	16							0E	1E						N	.	.	.	.	Z	C	ASL	
BIT (1)	Pm	ALΛB	AΛW	89		24	34							2C	3C						N	V	.	.	.	Z	.	BIT	
CMP	Pm	AL-B	A-W	C9		C5	D5		D2	C1	D1	C7	D7	CD	DD	D9	CF	DF	C3	D3	N	.	.	.	.	Z	C	CMP	
CPX	Px	XL-B	X-W	E0		E4								EC							N	.	.	.	.	Z	C	CPX	
CPY	Px	YL-B	Y-W	C0		C4								CC							N	.	.	.	.	Z	C	CPY	
DEC (2)	Pm	B-1→B	W-1→W		3A	C6	D6							CE	DE						N	.	.	.	.	Z	.	DEC	
EOR	Pm	AL∨B→AL	A∨W→A	49		45	55		52	41	51	47	57	4D	5D	59	4F	5F	43	53	N	.	.	.	.	Z	.	EOR	
INC (2)	Pm	B+1→B	W+1→W		1A	E6	F6							EE	FE						N	.	.	.	.	Z	.	INC	
LDA	Pm	B→AL	W→A	A9		A5	B5		B2	A1	B1	A7	B7	EA	BD	B9	AF	BF	A3	B3	N	.	.	.	.	Z	.	LDA	
LDX	Px	B→XL	W→X	A2		A6		B6						AE		BE					N	.	.	.	.	Z	.	LDX	
LDY	Px	B→YL	W→Y	A0		A4	B4							AC	BC						N	.	.	.	.	Z	.	LDY	
LSR (2)	Pm	0→B→Pc	0→W→Pc		4A	46	56							4E	5E						0	.	.	.	.	Z	C	LSR	
ORA	Pm	AL∨B→AL	A∨W→A	09		05	15		12	01	11	07	17	0D	1D	19	0F	1F	03	13	N	.	.	.	.	Z	.	ORA	
ROL (2)	Pm	Pc→B→Pc	Pc→W→Pc		2A	26	36							2E	3E						N	.	.	.	.	Z	C	ROL	
ROR (2)	Pm	PC→B→Pc	Pc→W→Pc		6A	66	76							6E	7E						N	.	.	.	.	Z	C	ROR	
SBC	Pm	AL-B-Pc→AL	A-W-Pc→A	E9		E5	F5		F2	E1	F1	E7	F7	ED	FD	F9	EF	FF	E3	F3	N	V	.	.	.	Z	C	SBC	
STA (7)	Pm	AL→B	A→W			85	95		92	81	91	87	97	8D	9D	99	8F	9F	83	93	.	.	.	.	.	.	.	STA	
STX	Px	XL→B	X→W			86		96						8E							.	.	.	.	.	.	.	STX	
STY	Px	YL→B	Y→W			84	94							8C							.	.	.	.	.	.	.	STY	
STZ (7)	Pm	0→B	0→W			64	74							9C	9E						.	.	.	.	.	.	.	STZ	
TRB (8)	Pm	ALΛB→B	AΛW→W			14								1C							.	.	.	.	Z	.	TRB		
TSB (8)	Pm	AL∨B→B	A∨W→W			04								0C							.	.	.	.	Z	.	TSB		

← add one cycle if DL ≠ 0 →

Emulation (E=1) or Native (E=0) Mode, 8 bit (M/X=1)	cycles	2	2	3	4	4	5	6	5 (3)	6	6	4	4 (3)	4 (3)	5	5	4	7
	bytes	2	1	2	2	2	2	2	2	2	2	3	3	3	4	4	2	2
Native Mode (E=0), 16 bit (M/X=0)	cycles	3	2	4	5	5	6	7	6	7	7	5	5	5	6	5	5	8
	bytes	3	1	2	2	2	2	2	2	2	2	3	3	3	4	4	2	2

- V logical OR
- Λ logical AND
- ∨ logical exclusive OR
- + arithmetic addition
- arithmetic subtraction
- ≠ not equal
- status bit not affected
- B byte per effective address
- W word per effective address
- r relative offset
- A Accumulator, AL low half of Accumulator
- X Index Register, XL low half of X register
- Y Index Register, YL low half of Y register
- Pc carry bit
- M/X effective mode bit in Status Register (Pm or Px)
- Ws word per stack pointer
- Bs byte per stack pointer

Notes:

1. BIT instruction does not affect N and V flags when using immediate addressing mode. When using other addressing modes, the N and V flags are respectively set to bits 7 and 6 or 15 and 14 of the addressed memory depending on mode (byte or word).
2. For all Read/Modify/Write instruction addressing modes except accumulator—  
Add 2 cycles for E=1 or E=0 and Pm=1 (8-bit mode).  
Add 3 cycles for E=0 and Pm=0 (16-bit mode).
3. Add one cycle when indexing across page boundary and E=1 except for STA and STZ instructions.
4. If E=1 then 1→SH and XL→SL. If E=0 then X→S regardless of Pm or Px.
5. Exchanges the carry (Pc) and E bits. Whenever the E bit is set the following registers and status bits are locked into the indicated state: XH=0, YH=0, SH=1, Pm=1, Px=1.
6. Add 1 cycle if branch is taken. In Emulation (E=1) mode only—add 1 cycle if the branch is taken and crosses a page boundary.
7. Add 1 cycle in Emulation mode (E=1) for (dir),y; abs,x; and abs,y addressing modes.
8. With TSB and TRB instruction, the Z flag is set or cleared by the result of ALB or AΛW.  
For all Read/Modify/Write instruction addressing modes except accumulator—  
Add 2 cycles for E=1 or E=0 and Pm=1 (8-bit mode).  
Add 3 cycles for E=0 and Pm=0 (16-bit mode).

**Table 6. Branch, Transfer, Push, Pull, and Implied Addressing Mode Instructions**

Mnemonic	Bytes	M/X	Cycles	Operation		Implied	Stack	Relative	Status								Mnemonic
				8 Bit	Cycles				16 Bit	N	V	M	X	D	I	Z	
BCC (6)	2	—	2	PC+r→PC	2	PC+r→PC		90	.	.	.	.	.	.	.	.	BCC
BCS (6)	2	—	2	PC+r→PC	2	PC+r→PC		B0	.	.	.	.	.	.	.	.	BCS
BEQ (6)	2	—	2	PC+r→PC	2	PC+r→PC		F0	.	.	.	.	.	.	.	.	BEQ
BMI (6)	2	—	2	PC+r→PC	2	PC+r→PC		30	.	.	.	.	.	.	.	.	BMI
BNE (6)	2	—	2	PC+r→PC	2	PC+r→PC		D0	.	.	.	.	.	.	.	.	BNE
BPL (6)	2	—	2	PC+r→PC	2	PC+r→PC		10	.	.	.	.	.	.	.	.	BPL
BRA (6)	2	—	2	PC+r→PC	2	PC+r→PC		80	.	.	.	.	.	.	.	.	BRA
BVC (6)	2	—	2	PC+r→PC	2	PC+r→PC		50	.	.	.	.	.	.	.	.	BVC
BVS (6)	2	—	2	PC+r→PC	2	PC+r→PC		70	.	.	.	.	.	.	.	.	BVS
CLC	1	—	2	0→Pc	2	0→Pc	18		.	.	.	.	.	.	0	.	CLC
CLD	1	—	2	0→Pd	2	0→Pd	D8		.	.	.	.	.	.	0	.	CLD
CLI	1	—	2	0→Pi	2	0→Pi	58		.	.	.	.	.	.	0	.	CLI
CLV	1	—	2	0→Pv	2	0→Pv	B8		.	0	.	.	.	.	.	.	CLV
DEX	1	Px	2	XL-1→XL	2	X-1→X	CA		N	.	.	.	.	.	Z	.	DEX
DEY	1	Px	2	YL-1→YL	2	Y-1→Y	88		N	.	.	.	.	.	Z	.	DEY
INX	1	Px	2	XL+1→XL	2	X+1→X	E8		N	.	.	.	.	.	Z	.	INX
INY	1	Px	2	YL+1→YL	2	Y+1→Y	C8		N	.	.	.	.	.	Z	.	INY
NOP	1	—	2	no operation	2	no operation	EA		.	.	.	.	.	.	.	.	NOP
PEA	3	—	5	W→Ws, S-2→S	5	same		F4	.	.	.	.	.	.	.	.	PEA
PEI	2	—	6	W→Ws, S-2→S	6	same		D4	.	.	.	.	.	.	.	.	PEI
PER	3	—	6	W→Ws, S-2→S	6	same		62	.	.	.	.	.	.	.	.	PER
PHA	1	Pm	3	AL→Bs, S-1→S	4	A→Ws, S-2→S		48	.	.	.	.	.	.	.	.	PHA
PHB	1	—	3	DB→Bs, S-1→S	3	same		8B	.	.	.	.	.	.	.	.	PHB
PHD	1	—	4	D→Ws, S-2→S	4	same		0B	.	.	.	.	.	.	.	.	PHD
PHK	1	—	3	PB→Bs, S-1→S	3	same		4B	.	.	.	.	.	.	.	.	PHK
PHP	1	—	3	P→Bs, S-1→S	3	same		08	.	.	.	.	.	.	.	.	PHP
PHX	1	Px	3	XL→Bs, S-1→S	4	X→Ws, S-2→S		DA	.	.	.	.	.	.	.	.	PHX
PHY	1	Px	3	YL→Bs, S-1→S	4	Y→Ws, S-2→S		5A	.	.	.	.	.	.	.	.	PHY
PLA	1	Pm	4	S+1→S, Bs→AL	5	S+2→S, Ws→A		68	N	.	.	.	.	.	Z	.	PLA
PLB	1	—	4	S+1→S, Bs→DB	4	same		AB	N	.	.	.	.	.	Z	.	PLB
PLD	1	—	5	S+2→S, Ws→D	5	same		2B	N	.	.	.	.	.	Z	.	PLD
PLP	1	—	4	S+1→S, Bs→P	4	same		28	N	V	M	X	D	I	Z	C	PLP
PLX	1	Px	4	S+1→S, Bs→XL	5	S+2→S, Ws→X		FA	N	.	.	.	.	.	Z	.	PLX
PLY	1	Px	4	S+1→S, Bs→YL	5	S+2→S, Ws→Y		7A	N	.	.	.	.	.	Z	.	PLY
SEC	1	—	2	1→Pc	2	1→Pc	38		.	.	.	.	.	.	1	.	SEC
SED	1	—	2	1→Pd	2	1→Pd	F8		.	.	.	.	.	.	1	.	SED
SEI	1	—	2	1→Pi	2	1→Pi	78		.	.	.	.	.	.	1	.	SEI
TAX	1	Px	2	AL→XL	2	A→X	AA		N	.	.	.	.	.	Z	.	TAX
TAY	1	Px	2	AL→YL	2	A→Y	A8		N	.	.	.	.	.	Z	.	TAY
TCD	1	—	2	A→D	2	A→D	5B		N	.	.	.	.	.	Z	.	TCD
TCS	1	—	2	A→S	2	A→S	1B		.	.	.	.	.	.	.	.	TCS
TDC	1	—	2	D→A	2	D→A	7B		N	.	.	.	.	.	Z	.	TDC
TSC	1	—	2	S→A	2	S→A	3B		N	.	.	.	.	.	Z	.	TSC
TSX	1	Px	2	SL→XL	2	S→X	BA		N	.	.	.	.	.	Z	.	TSX
TXA	1	Pm	2	XL→AL	2	X→A	8A		N	.	.	.	.	.	Z	.	TXA
TXS	1	—	2	see note 4	2	X→S	9A		.	.	.	.	.	.	.	.	TXS
TXY	1	Px	2	XL→YL	2	X→Y	9B		N	.	.	.	.	.	Z	.	TXY
TYA	1	Pm	2	YL→AL	2	Y→A	98		N	.	.	.	.	.	Z	.	TYA
TYX	1	Px	2	YL→XL	2	Y→X	BB		N	.	.	.	.	.	Z	.	TYX
XCE	1	—	2	see note 5	2	see note 5	FB		.	.	.	.	.	.	.	C	XCE

See Notes on page 13.

Table 7. Other Addressing Mode Instructions

Mnemonic	Addressing Mode	Op Code	Cycles	Bytes	Status							Mnemonic	Function	
					N	V	M	X	D	I	Z			C
BRK	stack	00	7/8	2	.	.	.	.	0	1	.	.	BRK	See discussion in Interrupt Processing Sequence section.
BRL	relative long	82	3	3	.	.	.	.	.	.	.	BRL	PC+r→PC where -32768<r<32767. See discussion in Interrupt Processing Sequence section.	
COP	stack	02	7/8	2	.	.	.	.	0	1	.	.		COP
JML	absolute indirect	DC	6	3	.	.	.	.	.	.	.	JML	W→PC, B→PB	
JMP	absolute	4C	3	3	.	.	.	.	.	.	.	JMP	W→PC	
JMP	absolute indirect	6C	5	3	.	.	.	.	.	.	.	JMP	W→PC	
JMP	absolute indexed indirect	7C	6	3	.	.	.	.	.	.	.	JMP	W→PC	
JMP	absolute long	5C	4	4	.	.	.	.	.	.	.	JMP	W→PC, B→PB	
JSL	absolute long	22	8	4	.	.	.	.	.	.	.	JSL	PB→Bs, S-1→S, PC→Ws, S-2→S, W→PC, B→PB	
JSR	absolute	20	6	3	.	.	.	.	.	.	.	JSR	PC→Ws, S-2→S, W→PC	
JSR	absolute indexed indirect	FC	6	3	.	.	.	.	.	.	.	JSR	PC→Ws, S-2→S, W→PC	
MVN	block	54	7/byte	3	.	.	.	.	.	.	.	MVN	See discussion in Addressing Mode section	
MVP	block	44	7/byte	3	.	.	.	.	.	.	.	MVP	P/Ā→P S+1→S, Bs→P, S+2→S, Ws→PC, if E=0 then S+1→S, Bs→PB S+2→S, Ws+1→PC, S+1→S, Bs→PB	
REP	immediate	C2	3	2	N	V	M	X	D	I	Z	C		REP
RTI	stack	40	6/7	1	N	V	M	X	D	I	Z	C		RTI
RTL	stack	6B	6	1	.	.	.	.	.	.	.	RTL		
RTS	stack	60	6	1	.	.	.	.	.	.	.	RTS	S+2→S, Ws+1→PC	
SEP	immediate	E2	3	2	N	V	M	X	D	I	Z	C	SEP	PVB→P
STP	implied	DB	3+	1	.	.	.	.	.	.	.	STP	Stop the clock. Requires reset to continue.	
WAI	implied	CB	3+	1	.	.	.	.	.	.	.	WAI	Wait for interrupt. RDY held low until interrupt.	
XBA	implied	EB	3	1	N	.	.	.	.	.	Z	XBA	Swap AH and AL. Status bits reflect final condition of AL.	

See Notes on page 13.

**Table 8. Opcode Matrix**

MSD	LSD																MSD
	0	1	2	3	4	5	6	7	8	9	A	B	C	D	E	F	
0	BRK s 2 8	ORA (d,x) 2 6	COP s 2 8	ORA r,s 2 4	TSB d 2 5	ORA d 2 3	ASL d 2 5	ORA [d] 2 6	PHP s 1 3	ORA # 2 2	ASL A 1 2	PHD s 1 4	TSB a 3 6	ORA a 3 4	ASL a 3 6	ORA al 4 5	
1	BPL r 2 2	ORA (d,y) 2 5	ORA (d) 2 5	ORA (r,s),y 2 7	TRB d 2 5	ORA d,x 2 4	ASL d,x 2 6	ORA [d],y 2 6	CLC i 1 2	ORA a,y 3 4	INC A 1 2	TCS i 1 2	TRB a 3 6	ORA a,x 3 4	ASL a,x 3 7	ORA al,x 4 5	
2	JSR a 3 6	AND (d,x) 2 6	JSL al 4 8	AND r,s 2 4	BIT d 2 3	AND d 2 3	ROL d 2 5	AND [d] 2 6	PLP s 1 4	AND # 2 2	ROL A 1 2	PLD s 1 5	BIT a 3 4	AND a 3 4	ROL a 3 6	AND al 4 5	
3	BMI r 2 2	AND (d,y) 2 5	AND (d) 2 5	AND (r,s),y 2 7	BIT d,x 2 4	AND d,x 2 4	ROL d,x 2 6	AND [d],y 2 6	SEC i 1 2	AND a,y 3 4	DEC A 1 2	TSC i 1 2	BIT a,x 3 4	AND a,x 3 4	ROL a,x 3 7	AND al,x 4 5	
4	RTI s 1 7	EOR (d,x) 2 6	reserve 2 2	EOR r,s 2 4	MVP xya 3 7	EOR d 2 3	LSR d 2 5	EOR [d] 2 6	PHA s 1 3	EOR # 2 2	LSR A 1 2	PHK s 1 3	JMP a 3 3	EOR a 3 4	LSR a 3 6	EOR al 4 5	
5	BVC r 2 2	EOR (d,y) 2 5	EOR (d) 2 5	EOR (r,s),y 2 7	MVN xya 3 7	EOR d,x 2 4	LSR d,x 2 6	EOR [d],y 2 6	CLI i 1 2	EOR a,y 3 4	PHY s 1 3	TCD i 1 2	JMP al 4 4	EOR a,x 3 4	LSR a,x 3 7	EOR al,x 4 5	
6	RTS s 1 6	ADC (d,x) 2 6	PER s 3 6	ADC r,s 2 4	STZ d 2 3	ADC d 2 3	ROR d 2 5	ADC [d] 2 6	PLA s 1 4	ADC # 2 2	ROR A 1 2	RTL s 1 6	JMP (a) 3 5	ADC a 3 4	ROR a 3 6	ADC al 4 5	
7	BVS r 2 2	ADC (d,y) 2 5	ADC (d) 2 5	ADC (r,s),y 2 7	STZ d,x 2 4	ADC d,x 2 4	ROR d,x 2 6	ADC [d],y 2 6	SEI i 1 2	ADC a,y 3 4	PLY s 1 4	TDC i 1 2	JMP (a,x) 3 6	ADC a,x 3 4	ROR a,x 3 7	ADC al,x 4 5	
8	BRA r 2 2	STA (d,x) 2 6	BRL rl 3 3	STA r,s 2 4	STY d 2 3	STA d 2 3	STX d 2 3	STA [d] 2 6	DEY i 1 2	BIT # 2 2	TXA i 1 2	PHB s 1 3	STY a 3 4	STA a 3 4	STX a 3 4	STA al 4 5	
9	BCC r 2 2	STA (d,y) 2 6	STA (d) 2 5	STA (r,s),y 2 7	STY d,x 2 4	STA d,x 2 4	STX d,y 2 4	STA [d],y 2 6	TYA i 1 2	STA a,y 3 5	TXS i 1 2	TXY i 1 2	STZ a 3 4	STA a,x 3 5	STZ a,x 3 5	STA al,x 4 5	
A	LDY # 2 2	LDA (d,x) 2 6	LDX # 2 2	LDA r,s 2 4	LDY d 2 3	LDA d 2 3	LDX d 2 3	LDA [d] 2 6	TAY i 1 2	LDA # 2 2	TAX i 1 2	PLB s 1 4	LDY a 3 4	LDA a 3 4	LDX a 3 4	LDA al 4 5	
B	BCS r 2 2	LDA (d,y) 2 5	LDA (d) 2 5	LDA (r,s),y 2 7	LDY d,x 2 4	LDA d,x 2 4	LDX d,y 2 4	LDA [d],y 2 6	CLV i 1 2	LDA a,y 3 4	TSX i 1 2	TYX i 1 2	LDY a,x 3 4	LDA a,x 3 4	LDX a,y 3 4	LDA al,x 4 5	
C	CPY # 2 2	CMP (d,x) 2 6	REP # 2 3	CMP r,s 2 4	CPY d 2 3	CMP d 2 3	DEC d 2 5	CMP [d] 2 6	INY i 1 2	CMP # 2 2	DEX i 1 2	WAI i 1 3	CPY a 3 4	CMP a 3 4	DEC a 3 6	CMP al 4 5	
D	BNE r 2 2	CMP (d,y) 2 5	CMP (d) 2 5	CMP (r,s),y 2 7	PEI s 2 6	CMP d,x 2 4	DEC d,x 2 6	CMP [d],y 2 6	CLD i 1 2	CMP a,y 3 4	PHX s 1 3	STP i 1 3	JML (a) 3 6	CMP a,x 3 4	DEC a,x 3 7	CMP al,x 4 5	
E	CPX # 2 2	SBC (d,x) 2 6	SEP # 2 3	SBC r,s 2 4	CPX d 2 3	SBC d 2 3	INC d 2 5	SBC [d] 2 6	INX i 1 2	SBC # 2 2	NOP i 1 2	XBA i 1 3	CPX a 3 4	SBC a 3 4	INC a 3 6	SBC al 4 5	
F	BEQ r 2 2	SBC (d,y) 2 5	SBC (d) 2 5	SBC (r,s),y 2 7	PEA s 3 5	SBC d,x 2 4	INC d,x 2 6	SBC [d],y 2 6	SED i 1 2	SBC a,y 3 4	PLX s 1 4	XCE i 1 2	JSR (a,x) 3 6	SBC a,x 3 4	INC a,x 3 7	SBC al,x 4 5	
	0	1	2	3	4	5	6	7	8	9	A	B	C	D	E	F	

symbol	addressing mode	symbol	addressing mode
#	immediate	[d]	direct indirect long
A	accumulator	[d],y	direct indirect indexed long
r	program counter relative	a	absolute
rl	program counter relative long	a,x	absolute indexed (with x)
i	implied	a,y	absolute indexed (with y)
s	stack	al	absolute long
d	direct	al,x	absolute indexed long
d,x	direct indexed (with x)	r,s	stack relative
d,y	direct indexed (with y)	(r,s),y	stack relative indirect indexed
(d)	direct indirect	(a)	absolute indirect
(d,x)	direct indexed indirect	(a,x)	absolute indexed indirect
(d,y)	direct indirect indexed	xya	block move

legend	
instruction mnemonic	addressing mode
base number of bytes	base number of cycles



## Pin Function Table

Pin	Description
A0-A15	Address Bus
$\overline{\text{ABORT}}$	Abort Input
BE	Bus Enable
$\phi 2$ (IN)	Phase 2 In Clock
$\phi 1$ (OUT)	Phase 1 Out Clock
$\phi 2$ (OUT)	Phase 2 Out Clock
D0-D7	Data Bus (G65SC802)
D0/A16-D7/A23	Data Bus, Multiplexed (G65SC816)
E	Emulation Select
$\overline{\text{IRQ}}$	Interrupt Request
ML	Memory Lock
M/X	Mode Select (Pm or Px)

Pin	Description
NC	No Connection
$\overline{\text{NMI}}$	Non-Maskable Interrupt
RDY	Ready
$\overline{\text{RES}}$	Reset
R/W	Read/Write
$\overline{\text{SO}}$	Set Overflow
SYNC	Synchronize
VDA	Valid Data Address
$\overline{\text{VP}}$	Vector Pull
VPA	Valid Program Address
VDD	Positive Power Supply (+5 Volts)
VSS	Internal Logic Ground

## Pin Configuration

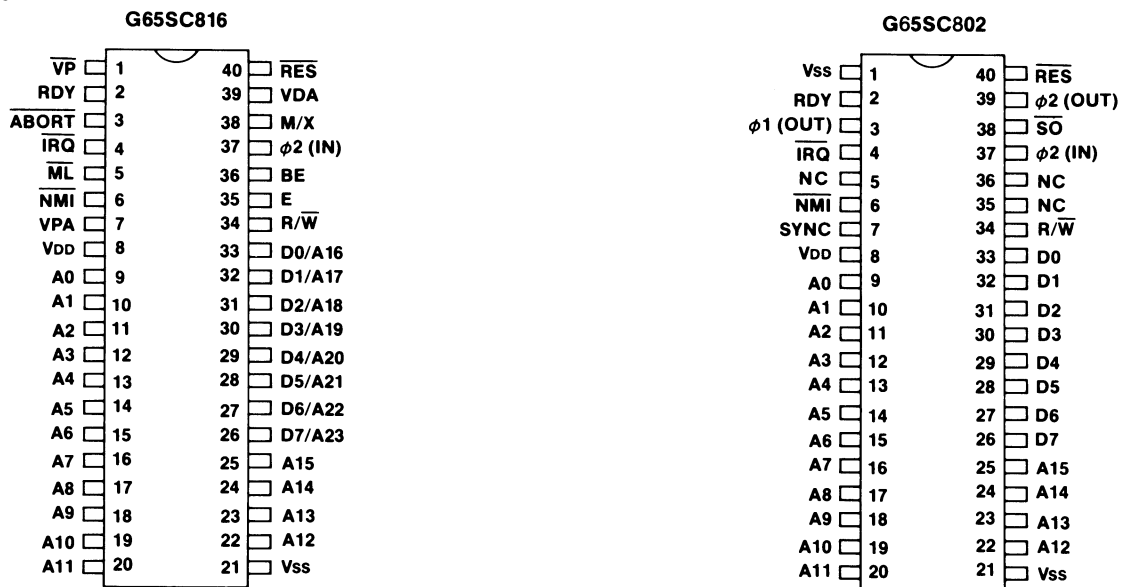

## Ordering Information

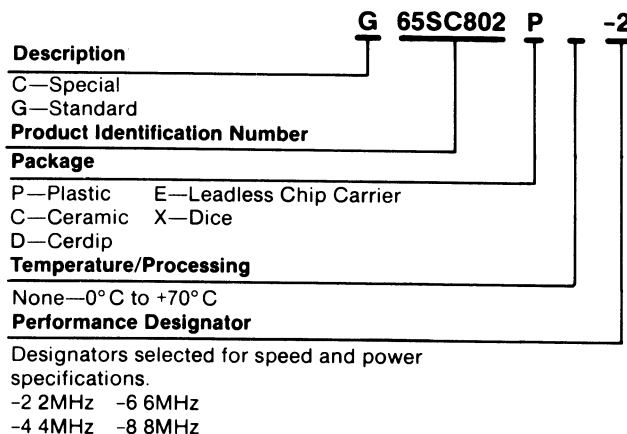

# Packaging Information

## Ceramic Package

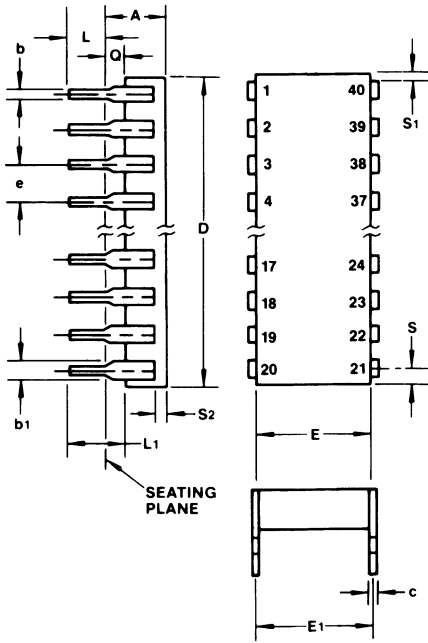

## Plastic & Cerdip Package

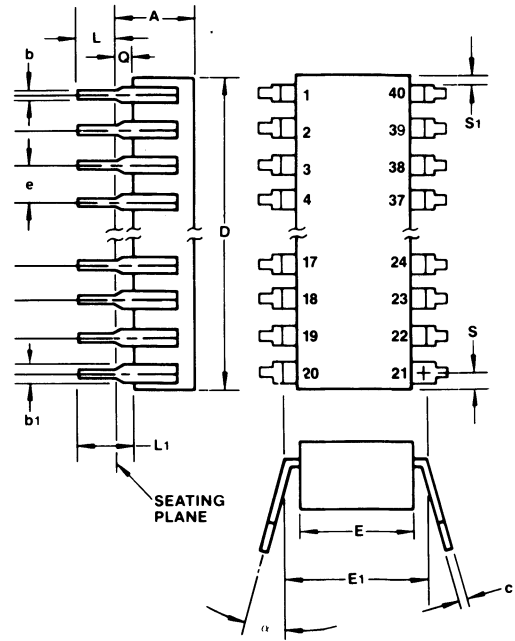

40-PIN PACKAGE				
SYM-BOL	INCHES		MILLIMETERS	
	MIN	MAX	MIN	MAX
A	—	0.225	—	5.72
b	0.014	0.023	0.36	0.58
b1	0.030	0.070	0.76	1.78
c	0.008	0.015	0.20	0.38
D	—	2.096	—	53.24
E	0.510	0.620	12.95	15.75
E1	0.520	0.630	13.21	16.00
e	0.100 BSC		2.54 BSC	
L	0.125	0.200	3.18	5.08
L1	0.150	—	3.81	—
Q	0.020	0.060	0.51	1.52
S	—	0.098	—	2.49
S1	0.005	—	0.13	—
S2	0.005	—	0.13	—
α	0°	15°	0°	15°

---

**Notes:**



**Sales Offices:** Technical or sales assistance may be requested from the GTE Microcircuits area sales office nearest you.

**Western**  
GTE Microcircuits  
2100 N. Sepulveda Blvd.  
Suite 27  
Manhattan Beach, CA 90266  
Tel: 213/546-4731  
TWX: 910-321-5701

**Central**  
GTE Microcircuits  
Tel: 602/968-4431  
TWX: 910-951-1383

**Eastern**  
GTE Microcircuits  
380 Town Line Road  
Hauppauge, NY 11788  
Tel: 516/724-8300  
TWX: 510-226-7847

**Europe**  
GTE Microcircuits  
Montenstrasse 11  
8000 Munich 19  
West Germany  
Tel: 089/1 78 20 31  
Telex: 528452 gtemc d

**WARNING:**

**MOS CIRCUITS ARE SUBJECT TO DAMAGE FROM STATIC DISCHARGE**  
Internal static discharge circuits are provided to minimize part damage due to environmental static electrical charge build-ups. Industry established recommendations for handling MOS circuits include

- 1 Ship and store product in conductive shipping tubes or in conductive foam plastic. Never ship or store product in non-conductive plastic containers or non-conductive plastic foam material
- 2 Handle MOS parts only at conductive work stations
- 3 Ground all assembly and repair tools

**Represented in your area by:**

The information contained herein is provided gratuitously and without liability, to any user. Reasonable efforts have been made to verify the accuracy of the information but no guarantee whatsoever is given as to the accuracy or as to its applicability to particular uses. In every instance, it must be the responsibility of the user to determine the suitability of the products for each application. GTE Microcircuits products are not authorized for use as critical components in life support devices or systems. Nothing contained herein shall be construed as a recommendation to use any product in violation of existing patents or other rights of third parties. The sale of any GTE Microcircuits product is subject to all GTE Microcircuits Terms and Conditions of Sale and Sales Policies, copies of which are available upon request.