

G79LXX

 NEGATIVE VOLTAGE REGULATOR

Description

The G79LXX series of fixed-voltage monolithic integrated circuit voltage regulators are designed for a wide range of applications. These applications include on-card regulation for elimination of noise and distribution problems associated with single-point regulation. In addition, they can be used with power-pass elements to make high current voltage regulators. Each of these regulators can deliver up to 100mA of output current. The internal limiting and thermal shutdown features of these regulators make them essentially immune to overload. When used as a replacement for a Zener diode-resistor combination, an effective improvement in output impedance can be obtained together with lower-bias current.

Features

- Fixed output voltage of -5V, -6V, -8V, -9V, -12V, -15V, -18V, -24V
- Internal Short-Circuit Current Limiting
- Internal Thermal Overload Protection
- No External Components Required

Package Dimensions

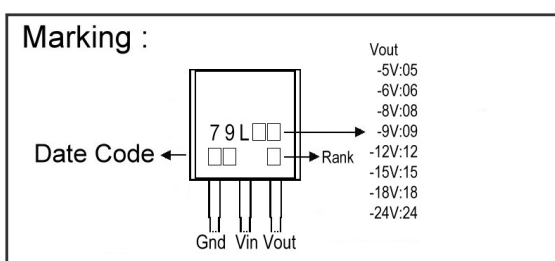
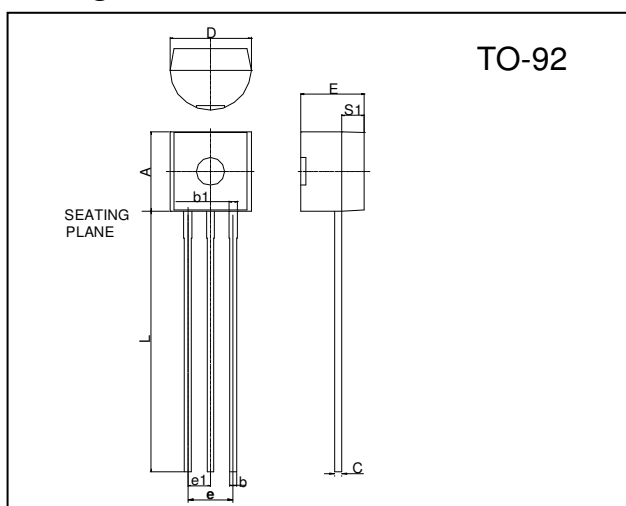

REF.	Millimeter		REF.	Millimeter	
	Min.	Max.		Min.	Max.
A	4.45	4.7	D	4.44	4.7
S1	1.02	-	E	3.30	3.81
b	0.36	0.51	L	12.70	-
b1	0.36	0.76	e1	1.15	1.39
C	0.36	0.51	e	2.42	2.66

Absolute Maximum Ratings

Parameter		Ratings	Unit
Input voltage	G79L05 ~ 09	-30	V
	G79L12 ~ 18	-35	V
	G79L24	-40	V
Output current		100	mA
Operating junction temperature range		0 ~ 125	°C
Storage temperature range		-65 ~ 150	°C
Power Dissipation		625*	mW

*When tested in free air condition, without heat sinking.

Electrical Characteristics

G79L05 (Refer to the test circuits, $T_j=0\sim 125^\circ\text{C}$, $I_o=40\text{mA}$, $V_{in}= -10\text{V}$, $C_{in}=0.33\mu\text{F}$, $C_o=0.1\mu\text{F}$ unless otherwise specified) (Note1)

Symbol		Min.	Typ.	Max.	Unit	Test Conditions
VO	A-Rank (3%)	-4.85	-5.0	-5.15	V	$V_{in}= -10\text{V}$, $I_o=40\text{mA}$, $T_j=25^\circ\text{C}$ $-7\text{V} \leq V_{in} \leq -20\text{V}$, $1\text{mA} \leq I_o \leq 40\text{mA}$ $V_{in}= -10\text{V}$, $1\text{mA} \leq I_o \leq 70\text{mA}$ (Note2)
	B-Rank (5%)	-4.75	-	-5.25		
ΔVO (Line Regulation)		-	15	150	mV	$-7\text{V} \leq V_{in} \leq -20\text{V}$, $I_o=40\text{mA}$, $T_j=25^\circ\text{C}$
ΔVO (Load Regulation)		-	20	60	mV	$V_{in}= -10\text{V}$, $1\text{mA} \leq I_o \leq 100\text{mA}$, $T_j=25^\circ\text{C}$
IQ		-	-	6.0	mA	$V_{in}= -10\text{V}$, $I_o=40\text{mA}$, $T_j=25^\circ\text{C}$
ΔIQ		-	-	0.1	mA	$V_{in}= -10\text{V}$, $1\text{mA} \leq I_o \leq 40\text{mA}$
		-	-	1.5		$-8\text{V} \leq V_{in} \leq -20\text{V}$, $I_o=40\text{mA}$
Vn		-	40	-	μV	$10\text{Hz} \leq f \leq 100\text{KHz}$
RR		41	49	-	dB	$-8\text{V} \leq V_{in} \leq -18\text{V}$, $I_o=40\text{mA}$, $f=120\text{Hz}$, $T_j=25^\circ\text{C}$
VD		-	1.7	-	V	$I_o=100\text{mA}$, $T_j=25^\circ\text{C}$

G79L06 (Refer to the test circuits, $T_j=0\sim 125^\circ\text{C}$, $I_o=40\text{mA}$, $V_{in}= -11\text{V}$, $C_{in}=0.33\mu\text{F}$, $C_o=0.1\mu\text{F}$ unless otherwise specified) (Note1)

Symbol		Min.	Typ.	Max.	Unit	Test Conditions
VO	A-Rank (3%)	-5.82	-6.0	-6.18	V	$V_{in}= -11\text{V}$, $I_o=40\text{mA}$, $T_j=25^\circ\text{C}$ $-8\text{V} \leq V_{in} \leq -20\text{V}$, $1\text{mA} \leq I_o \leq 40\text{mA}$ $V_{in}= -11\text{V}$, $1\text{mA} \leq I_o \leq 70\text{mA}$ (Note2)
	B-Rank (5%)	-5.70	-	-6.30		
ΔVO (Line Regulation)		-	20	150	mV	$-8\text{V} \leq V_{in} \leq -20\text{V}$, $I_o=40\text{mA}$, $T_j=25^\circ\text{C}$
ΔVO (Load Regulation)		-	21	60	mV	$V_{in}= -11\text{V}$, $1\text{mA} \leq I_o \leq 100\text{mA}$, $T_j=25^\circ\text{C}$
IQ		-	-	6.0	mA	$V_{in}= -11\text{V}$, $I_o=40\text{mA}$, $T_j=25^\circ\text{C}$
ΔIQ		-	-	0.1	mA	$V_{in}= -11\text{V}$, $1\text{mA} \leq I_o \leq 40\text{mA}$
		-	-	1.5		$-9\text{V} \leq V_{in} \leq -20\text{V}$, $I_o=40\text{mA}$
Vn		-	44	-	μV	$10\text{Hz} \leq f \leq 100\text{KHz}$
RR		40	48	-	dB	$-9\text{V} \leq V_{in} \leq 19\text{V}$, $I_o=40\text{mA}$, $f=120\text{Hz}$, $T_j=25^\circ\text{C}$
VD		-	1.7	-	V	$I_o=100\text{mA}$, $T_j=25^\circ\text{C}$

G79L08 (Refer to the test circuits, $T_j=0\sim 125^\circ\text{C}$, $I_o=40\text{mA}$, $V_{in}= -14\text{V}$, $C_{in}=0.33\mu\text{F}$, $C_o=0.1\mu\text{F}$ unless otherwise specified) (Note1)

Symbol		Min.	Typ.	Max.	Unit	Test Conditions
VO	A-Rank (3%)	-7.76	-8.0	-8.24	V	$V_{in}= -14\text{V}$, $I_o=40\text{mA}$, $T_j=25^\circ\text{C}$ $-10.5\text{V} \leq V_{in} \leq -23\text{V}$, $1\text{mA} \leq I_o \leq 40\text{mA}$ $V_{in}= -14\text{V}$, $1\text{mA} \leq I_o \leq 70\text{mA}$ (Note2)
	B-Rank (5%)	-7.60	-	-8.40		
ΔVO (Line Regulation)		-	42	175	mV	$-10.5\text{V} \leq V_{in} \leq -23\text{V}$, $I_o=40\text{mA}$, $T_j=25^\circ\text{C}$
ΔVO (Load Regulation)		-	30	80	mV	$V_{in}= -14\text{V}$, $1\text{mA} \leq I_o \leq 100\text{mA}$, $T_j=25^\circ\text{C}$
IQ		-	-	6.0	mA	$V_{in}= -14\text{V}$, $I_o=40\text{mA}$, $T_j=25^\circ\text{C}$
ΔIQ		-	-	0.1	mA	$V_{in}= -14\text{V}$, $1\text{mA} \leq I_o \leq 40\text{mA}$
		-	-	1.5		$-11\text{V} \leq V_{in} \leq -23\text{V}$, $I_o=40\text{mA}$
Vn		-	54	-	μV	$10\text{Hz} \leq f \leq 100\text{KHz}$
RR		37	46	-	dB	$-11\text{V} \leq V_{in} \leq -21\text{V}$, $I_o=40\text{mA}$, $f=120\text{Hz}$, $T_j=25^\circ\text{C}$
VD		-	1.7	-	V	$I_o=100\text{mA}$, $T_j=25^\circ\text{C}$

G79L09 (Refer to the test circuits, $T_j=0\sim 125^\circ\text{C}$, $I_o=40\text{mA}$, $V_{in}=-15\text{V}$, $C_{in}=0.33\mu\text{F}$, $C_o=0.1\mu\text{F}$ unless otherwise specified) (Note1)

Symbol		Min.	Typ.	Max.	Unit	Test Conditions
VO	A-Rank (3%)	-8.73	-9.0	-9.27	V	$V_{in}=-15\text{V}$, $I_o=40\text{mA}$, $T_j=25^\circ\text{C}$ $-11.5\text{V} \leq V_{in} \leq -24\text{V}$, $1\text{mA} \leq I_o \leq 40\text{mA}$ $V_{in}=-15\text{V}$, $1\text{mA} \leq I_o \leq 70\text{mA}$ (Note2)
	B-Rank (5%)	-8.55	-	-9.45		
ΔVO (Line Regulation)		-	42	200	mV	$-11.5\text{V} \leq V_{in} \leq -24\text{V}$, $I_o=40\text{mA}$, $T_j=25^\circ\text{C}$
ΔVO (Load Regulation)		-	30	90	mV	$V_{in}=-15\text{V}$, $1\text{mA} \leq I_o \leq 100\text{mA}$, $T_j=25^\circ\text{C}$
IQ		-	-	6.0	mA	$V_{in}=-15\text{V}$, $I_o=40\text{mA}$, $T_j=25^\circ\text{C}$
ΔIQ		-	-	0.1	mA	$V_{in}=-15\text{V}$, $1\text{mA} \leq I_o \leq 40\text{mA}$
		-	-	1.5		$-12\text{V} \leq V_{in} \leq -24\text{V}$, $I_o=40\text{mA}$
Vn		-	54	-	μV	$10\text{Hz} \leq f \leq 100\text{KHz}$
RR		37	46	-	dB	$-12\text{V} \leq V_{in} \leq -22\text{V}$, $I_o=40\text{mA}$, $f=120\text{Hz}$, $T_j=25^\circ\text{C}$
VD		-	1.7	-	V	$I_o=100\text{mA}$, $T_j=25^\circ\text{C}$

G79L12 (Refer to the test circuits, $T_j=0\sim 125^\circ\text{C}$, $I_o=40\text{mA}$, $V_{in}=-19\text{V}$, $C_{in}=0.33\mu\text{F}$, $C_o=0.1\mu\text{F}$ unless otherwise specified) (Note1)

Symbol		Min.	Typ.	Max.	Unit	Test Conditions
VO	A-Rank (3%)	-11.64	-12.0	-12.36	V	$V_{in}=-19\text{V}$, $I_o=40\text{mA}$, $T_j=25^\circ\text{C}$ $-14.5\text{V} \leq V_{in} \leq -27\text{V}$, $1\text{mA} \leq I_o \leq 40\text{mA}$ $V_{in}=-19\text{V}$, $1\text{mA} \leq I_o \leq 70\text{mA}$ (Note2)
	B-Rank (5%)	-11.40	-	-12.60		
ΔVO (Line Regulation)		-	50	250	mV	$-14.5\text{V} \leq V_{in} \leq -27\text{V}$, $I_o=40\text{mA}$, $T_j=25^\circ\text{C}$
ΔVO (Load Regulation)		-	24	100	mV	$V_{in}=-19\text{V}$, $1\text{mA} \leq I_o \leq 100\text{mA}$, $T_j=25^\circ\text{C}$
IQ		-	-	6.5	mA	$V_{in}=-19\text{V}$, $I_o=40\text{mA}$, $T_j=25^\circ\text{C}$
ΔIQ		-	-	0.1	mA	$V_{in}=-19\text{V}$, $1\text{mA} \leq I_o \leq 40\text{mA}$
		-	-	1.5		$-16\text{V} \leq V_{in} \leq -27\text{V}$, $I_o=40\text{mA}$
Vn		-	80	-	μV	$10\text{Hz} \leq f \leq 100\text{KHz}$
RR		37	42	-	dB	$-15\text{V} \leq V_{in} \leq -25\text{V}$, $I_o=40\text{mA}$, $f=120\text{Hz}$, $T_j=25^\circ\text{C}$
VD		-	1.7	-	V	$I_o=100\text{mA}$, $T_j=25^\circ\text{C}$

G79L15 (Refer to the test circuits, $T_j=0\sim 125^\circ\text{C}$, $I_o=40\text{mA}$, $V_{in}=-23\text{V}$, $C_{in}=0.33\mu\text{F}$, $C_o=0.1\mu\text{F}$ unless otherwise specified) (Note1)

Symbol		Min.	Typ.	Max.	Unit	Test Conditions
VO	A-Rank (3%)	-14.55	-15.0	-15.45	V	$V_{in}=-23\text{V}$, $I_o=40\text{mA}$, $T_j=25^\circ\text{C}$ $-17.5\text{V} \leq V_{in} \leq -30\text{V}$, $1\text{mA} \leq I_o \leq 40\text{mA}$ $V_{in}=-23\text{V}$, $1\text{mA} \leq I_o \leq 70\text{mA}$ (Note2)
	B-Rank (5%)	-14.25	-	-15.75		
ΔVO (Line Regulation)		-	65	300	mV	$-17.5\text{V} \leq V_{in} \leq -30\text{V}$, $I_o=40\text{mA}$, $T_j=25^\circ\text{C}$
ΔVO (Load Regulation)		-	25	150	mV	$V_{in}=-23\text{V}$, $1\text{mA} \leq I_o \leq 100\text{mA}$, $T_j=25^\circ\text{C}$
IQ		-	-	6.5	mA	$V_{in}=-23\text{V}$, $I_o=40\text{mA}$, $T_j=25^\circ\text{C}$
ΔIQ		-	-	0.1	mA	$V_{in}=-23\text{V}$, $1\text{mA} \leq I_o \leq 40\text{mA}$
		-	-	1.5		$-20\text{V} \leq V_{in} \leq -30\text{V}$, $I_o=40\text{mA}$
Vn		-	90	-	μV	$10\text{Hz} \leq f \leq 100\text{KHz}$
RR		34	39	-	dB	$-18.5\text{V} \leq V_{in} \leq -28.5\text{V}$, $I_o=40\text{mA}$, $f=120\text{Hz}$, $T_j=25^\circ\text{C}$
VD		-	1.7	-	V	$I_o=100\text{mA}$, $T_j=25^\circ\text{C}$

G79L18 (Refer to the test circuits, $T_j=0\sim 125^{\circ}\text{C}$, $I_o=40\text{mA}$, $V_{in}=-27\text{V}$, $C_{in}=0.33\mu\text{F}$, $C_o=0.1\mu\text{F}$ unless otherwise specified) (Note1)

Symbol		Min.	Typ.	Max.	Unit	Test Conditions
VO	A-Rank (3%)	-17.46	-18.0	-18.54	V	$V_{in}=-27\text{V}$, $I_o=40\text{mA}$, $T_j=25^{\circ}\text{C}$ $-20.5\text{V} \leq V_{in} \leq -33\text{V}$, $1\text{mA} \leq I_o \leq 40\text{mA}$ $V_{in}=-27\text{V}$, $1\text{mA} \leq I_o \leq 70\text{mA}$ (Note2)
	B-Rank (5%)	-17.10	-	-18.9		
ΔVO (Line Regulation)		-	70	300	mV	$-20.5\text{V} \leq V_{in} \leq -33\text{V}$, $I_o=40\text{mA}$, $T_j=25^{\circ}\text{C}$
ΔVO (Load Regulation)		-	27	170	mV	$V_{in}=-27\text{V}$, $1\text{mA} \leq I_o \leq 100\text{mA}$, $T_j=25^{\circ}\text{C}$
IQ		-	-	6.5	mA	$V_{in}=-27\text{V}$, $I_o=40\text{mA}$, $T_j=25^{\circ}\text{C}$
ΔIQ		-	-	0.1	mA	$V_{in}=-27\text{V}$, $1\text{mA} \leq I_o \leq 40\text{mA}$
		-	-	1.5		$-21\text{V} \leq V_{in} \leq -33\text{V}$, $I_o=40\text{mA}$
Vn		-	150	-	μV	$10\text{Hz} \leq f \leq 100\text{KHz}$
RR		33	48	-	dB	$-23\text{V} \leq V_{in} \leq -33\text{V}$, $I_o=40\text{mA}$, $f=120\text{Hz}$, $T_j=25^{\circ}\text{C}$
VD		-	1.7	-	V	$I_o=100\text{mA}$, $T_j=25^{\circ}\text{C}$

G79L24 (Refer to the test circuits, $T_j=0\sim 125^{\circ}\text{C}$, $I_o=40\text{mA}$, $V_{in}=-33\text{V}$, $C_{in}=0.33\mu\text{F}$, $C_o=0.1\mu\text{F}$ unless otherwise specified) (Note1)

Symbol		Min.	Typ.	Max.	Unit	Test Conditions
VO	A-Rank (3%)	-23.28	-24.0	-24.72	V	$V_{in}=-33\text{V}$, $I_o=40\text{mA}$, $T_j=25^{\circ}\text{C}$ $-27\text{V} \leq V_{in} \leq -38\text{V}$, $1\text{mA} \leq I_o \leq 40\text{mA}$ $V_{in}=-33\text{V}$, $1\text{mA} \leq I_o \leq 70\text{mA}$ (Note2)
	B-Rank (5%)	-22.80	-	-25.20		
ΔVO (Line Regulation)		-	90	350	mV	$-27\text{V} \leq V_{in} \leq -38\text{V}$, $I_o=40\text{mA}$, $T_j=25^{\circ}\text{C}$
ΔVO (Load Regulation)		-	40	200	mV	$V_{in}=-33\text{V}$, $1\text{mA} \leq I_o \leq 100\text{mA}$, $T_j=25^{\circ}\text{C}$
IQ		-	-	6.5	mA	$V_{in}=-33\text{V}$, $I_o=40\text{mA}$, $T_j=25^{\circ}\text{C}$
ΔIQ		-	-	0.1	mA	$V_{in}=-33\text{V}$, $1\text{mA} \leq I_o \leq 40\text{mA}$
		-	-	1.5		$-28\text{V} \leq V_{in} \leq -38\text{V}$, $I_o=40\text{mA}$
Vn		-	200	-	μV	$10\text{Hz} \leq f \leq 100\text{KHz}$
RR		31	47	-	dB	$-29\text{V} \leq V_{in} \leq -35\text{V}$, $I_o=40\text{mA}$, $f=120\text{Hz}$, $T_j=25^{\circ}\text{C}$
VD		-	1.7	-	V	$I_o=100\text{mA}$, $T_j=25^{\circ}\text{C}$

Note1: The Maximum steady state usable output current is dependent on input voltage, heat sinking, lead length of the package and copper of PCB. The data above represent pulse test conditions with junction temperatures specified at the initiation of test.

Note2: Power dissipation < 0.625W

Typical Application

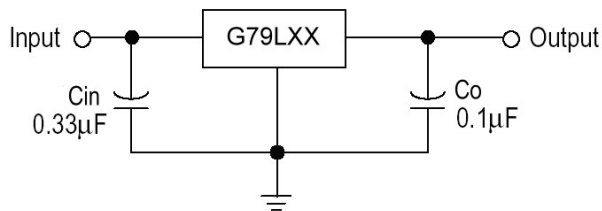

Characteristics Curve

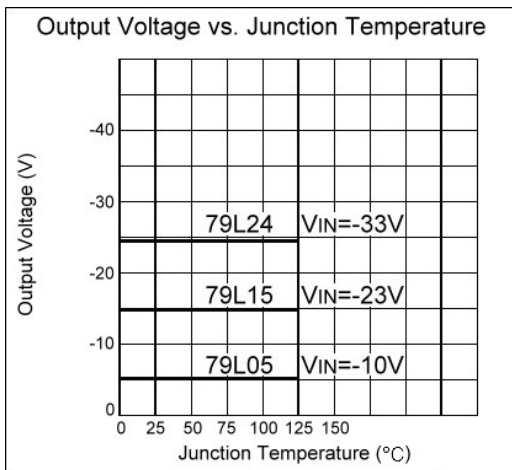
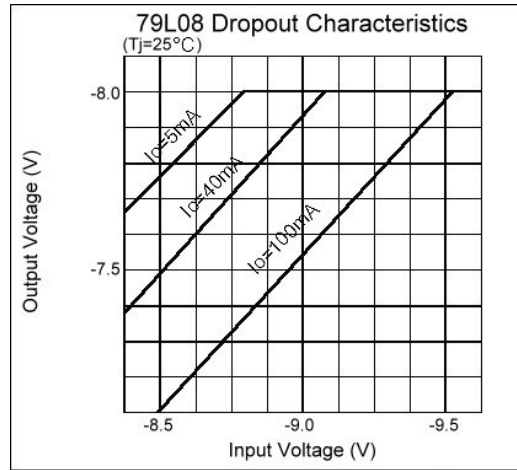
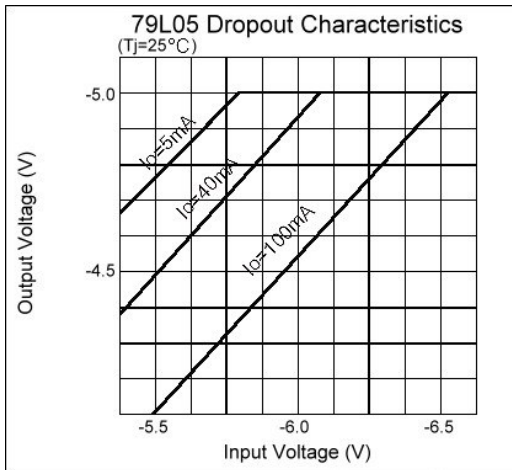
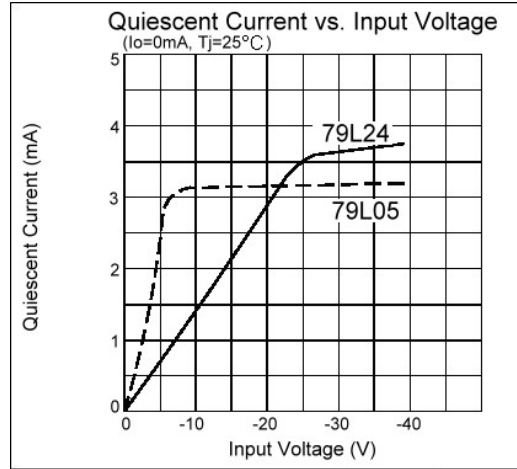
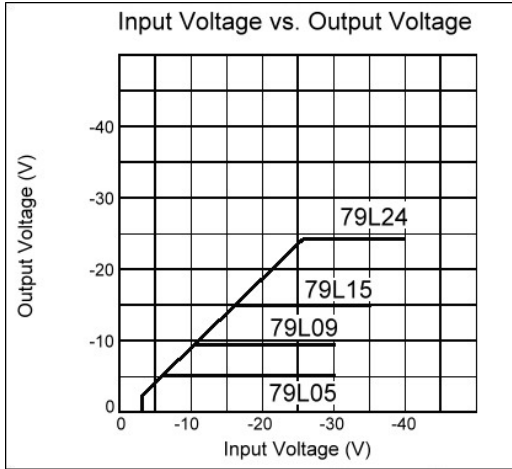

Important Notice:

- All rights are reserved. Reproduction in whole or in part is prohibited without the prior written approval of GTM.
- GTM reserves the right to make changes to its products without notice.
- GTM semiconductor products are not warranted to be suitable for use in life-support Applications, or systems.
- GTM assumes no liability for any consequence of customer product design, infringement of patents, or application assistance.

Head Office And Factory:

- Taiwan:** No. 17-1 Tatung Rd. Fu Kou Hsin-Chu Industrial Park, Hsin-Chu, Taiwan, R. O. C.
- TEL : 886-3-597-7061 FAX : 886-3-597-9220, 597-0785
- China:** (201203) No.255, Jang-Jiang Tsai-Lueng RD. , Pu-Dung-Hsin District, Shang-Hai City, China
- TEL : 86-21-5895-7671 ~ 4 FAX : 86-21-38950165