

InGaAs PIN photodiode

G8198 series

High-speed response at low reverse voltage

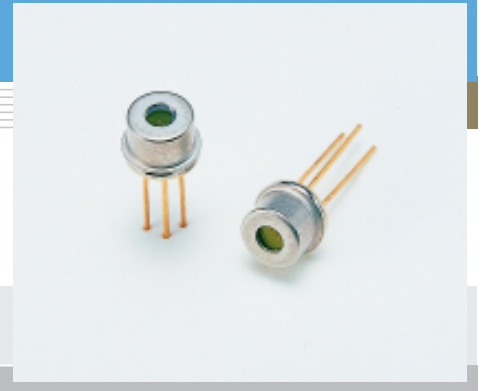

Features

- High-speed response at low reverse voltage
G8198-01: 3 GHz ($V_R=2$ V)
G8198-02: 2 GHz ($V_R=2$ V)
- Low noise, low dark current
- Low terminal capacitance
- Small package

Applications

- Optical fiber communications
- Fiber channel
- Gigabit Ethernet

■ Absolute maximum ratings ($T_a=25$ °C)

Parameter	Symbol	Value	Unit
Reverse voltage	V_R Max.	20	V
Operating temperature	T_{opr}	-40 to +85	°C
Storage temperature	T_{stg}	-55 to +125	°C

■ Specifications ($T_a=25$ °C)

Parameter	Symbol	Condition	G8198-01			G8198-02			Unit
			Min.	Typ.	Max.	Min.	Typ.	Max.	
Active area	-		-	$\phi 0.04$	-	-	$\phi 0.08$	-	mm
Spectral response range	λ		-	0.9 to 1.7	-	-	0.9 to 1.7	-	μm
Peak sensitivity wavelength	λ_p		-	1.55	-	-	1.55	-	μm
Photo sensitivity	S	$\lambda=1.3$ μm	0.8	0.9	-	0.8	0.9	-	A/W
		$\lambda=1.55$ μm	0.85	0.95	-	0.85	0.95	-	
Dark current	I_D	$V_R=5$ V	-	0.06	0.3	-	0.08	0.4	nA
Cut-off frequency	f_c	$V_R=2$ V, $R_L=50$ Ω $\lambda=1.3$ μm	-	3	-	-	2	-	GHz
Terminal capacitance	C_t	$V_R=2$ V $f=1$ MHz	-	0.6	-	-	0.9	-	pF

■ Spectral response

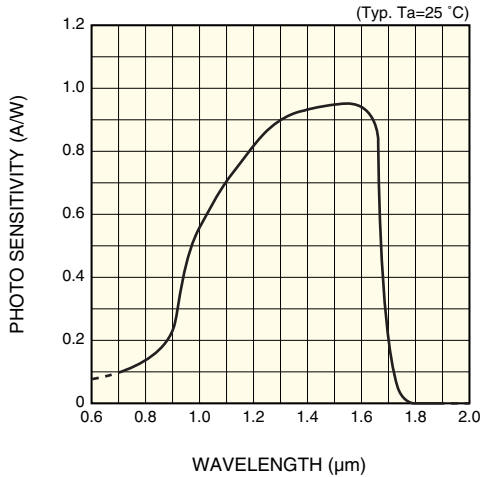

KIRDB0160EA

■ Dark current vs. reverse voltage

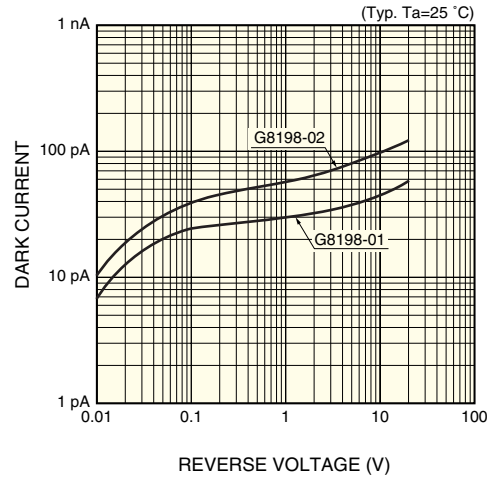

KIRDB0161EA

■ Terminal capacitance vs. reverse voltage

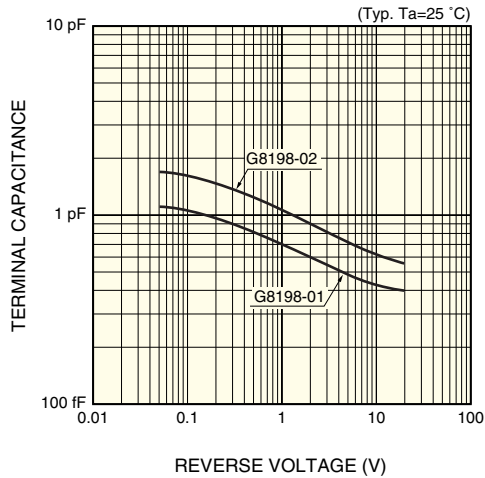

KIRDB0162EA

■ Frequency response

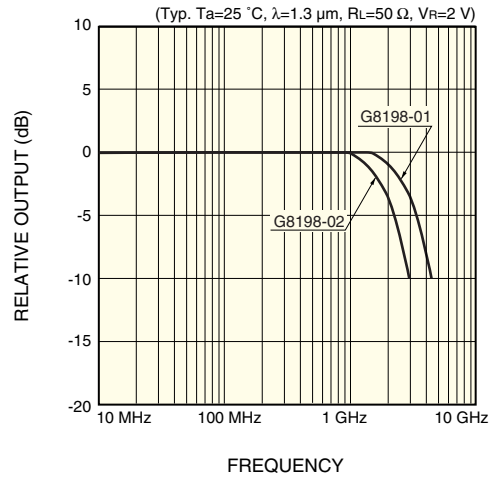

KIRDB0163EA

■ Dimensional outline (unit: mm)

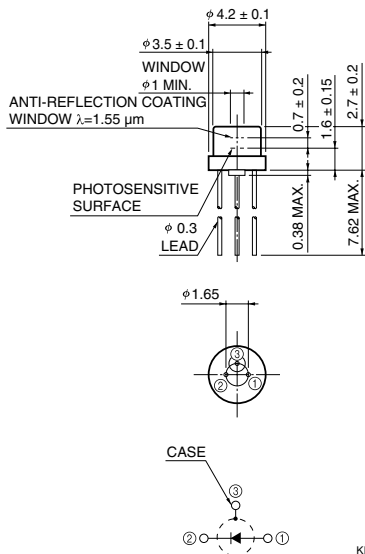

■ Eye diagram (photodiode output)

2.48832 Gbps
 Pin= -3 dBm
 $V_R=2.0$ V
 100 ps/div.

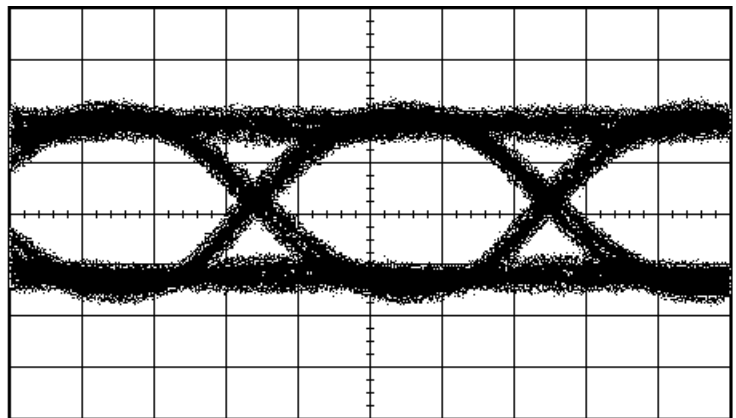

HAMAMATSU

Information furnished by HAMAMATSU is believed to be reliable. However, no responsibility is assumed for possible inaccuracies or omissions. Specifications are subject to change without notice. No patent rights are granted to any of the circuits described herein. ©2001 Hamamatsu Photonics K.K.

HAMAMATSU PHOTONICS K.K., Solid State Division

1126-1 Ichino-cho, Hamamatsu City, 435-8558 Japan, Telephone: (81) 053-434-3311, Fax: (81) 053-434-5184, <http://www.hamamatsu.com>

U.S.A.: Hamamatsu Corporation: 360 Foothill Road, P.O.Box 6910, Bridgewater, N.J. 08807-0910, U.S.A., Telephone: (1) 908-231-0960, Fax: (1) 908-231-1218

Germany: Hamamatsu Photonics Deutschland GmbH: Arzbergerstr. 10, D-82211 Herrsching am Ammersee, Germany, Telephone: (49) 08152-3750, Fax: (49) 08152-2658

France: Hamamatsu Photonics France S.A.R.L.: 8, Rue du Saule Trapu, Parc du Moulin de Massy, 91882 Massy Cedex, France, Telephone: 33-(1) 69 53 71 00, Fax: 33-(1) 69 53 71 10

United Kingdom: Hamamatsu Photonics UK Limited: 2 Howard Court, 10 Tewin Road, Welwyn Garden City, Hertfordshire AL7 1BW, United Kingdom, Telephone: (44) 1707-294888, Fax: (44) 1707-325777

North Europe: Hamamatsu Photonics Norden AB: Smidesvägen 12, SE-171 41 Solna, Sweden, Telephone: (46) 8-509-031-00, Fax: (46) 8-509-031-01

Italy: Hamamatsu Photonics Italia S.R.L.: Strada della Moia, 1/E, 20020 Arese, (Milano), Italy, Telephone: (39) 02-935-81-733, Fax: (39) 02-935-81-741