

■ Features

- Switching capacity up to 30A, 240VAC in miniature construction
- Various contact arrangements
- Meets UL508 and UL873 spacing requirements
- Available with open, dust cover and sealed versions
- Available with UL Class B and Class F insulation materials

■ Typical Applications

- Power switching
- Heating, refrigeration, ventilation
- Air conditioning
- Automotive
- Home appliances

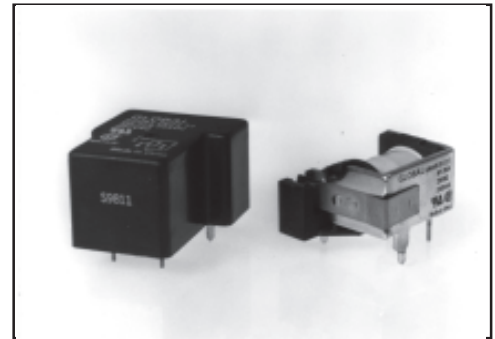

ULE155906/155573
CSA LR70042

■ Contact Data

Arrangement		1 Form A	1 Form B	1 Form C (NO)
1 Form C	(NC)			
Rated	240VAC	30A	15A	10A
Load	28VDC	30A	10A	10A
Material	AgCdO			
Max. Continuous Current		30A	15A	10A
Max. Switching Voltage	277VAC, 30 VDC			
Max. Switching Current	30A	15A	20A	10A
Max. Switching Power		8.31KVA, 900W	4.155KVA, 450W	5.54KVA, 600W
Min. Load		1A, 5VDC/12VAC		
Initial Resistance		50m ω at 100mA, 6VDC		
Service	Mechanical	10 ⁷ operations at operating frequency of 300 ops/min		
Life	Electrical	10 ⁵ operations at rated load and operating frequency of 6 ops/min		

■ UL/CSA Contact Ratings

		Contact Arrangement			
Voltage	Load Type	1 Form A	1 Form B	1 Form C (NO)	1 Form C (NC)
240VAC	General Purpose	30A	15A	20A	10A
240VAC	Resistive	30A	15A	20A	10A
240VAC	Motor	2 HP	0.5 HP	2 HP	0.5 HP
120VAC	Motor	1 HP	0.25 HP	1 HP	0.25 HP
240VAC	LRA/FLA	80/30	30/10	50/20	20/7
120VAC	Tungsten	TV 5	TV 3	TV 5	TV 3
277VAC	Ballast	10A	3A	10A	3A
28VDC	Resistive	20A	10A	20A	10A

■ Characteristics

Operate Time	15 ms, max.
Release Time	10 ms, max.
Insulation Resistance	1000M ω , min. at 500VDC, 50% RH
Dielectric Strength	1500 Vrms, 1 min. Coil to contacts, UL508 Spacing (AC/DC) 2500 Vrms, 1 min. Coil to contacts, UL873 Spacing (DC) 1500 Vrms, 1 min. Contact to Contact.
Shock Resistance	10g, 11ms, functional; 100g, destructive
Vibration Resistance	DA 1.5mm, 10–55Hz, functional
Power Consumption	1W, approx.
Ambient Temperature	-55°C to +85°C operating; -40°C to +130°C storage
Weight	G90: Open; 20g, Covered 26g, approx. G901/G902: 33g approx.

■ Coil Data

DC

Coil Voltage Code	Nominal Voltage (VDC)	Resistance ($\pm 10\%$) ω	Nominal Current (mA)	Must Operate Voltage Max. (V)	Must Release Voltage Min. (V)
005	5	27	185	3.75	0.5
006	6	40	150	4.5	0.6
009	9	97	92	6.75	0.9
012	12	155	77	9.	1.2
015	15	256	59	11.25	1.5
024	24	660	36	18.	2.4
048	48	2560	19	36.	4.8
110	110	10330	8.2	82.5	11.0

AC

012	12	26		10.2	1.8
024	24	106		20.4	3.6
110	110	2300		93.5	16
220	220	8950		187	33

■ How to order

G90 1 C S - DC18 - 1 2

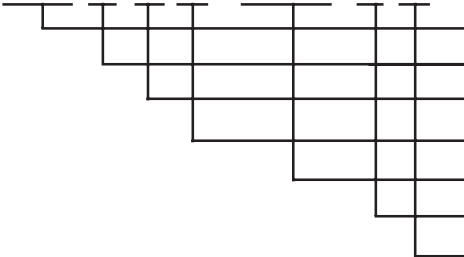

Model

Mounting: Nil=PCB, 1=PCB w/Top QC, 2=Panel w/ all QC

Contact Form: A, B, or C

Covering: O=Open Frame, D=Dust Cover, S=Sealed

Coil: DC 5, 6, 9, 12, 15, 18, 24, 48, 110; AC 12, 24, 48, 110, 220

Spacing: Nil=Std UL508, 1=UL873*

Insulation: Nil=Std. Class B, 2= Class F

■ **Coil Temperature Rise**

G90 type

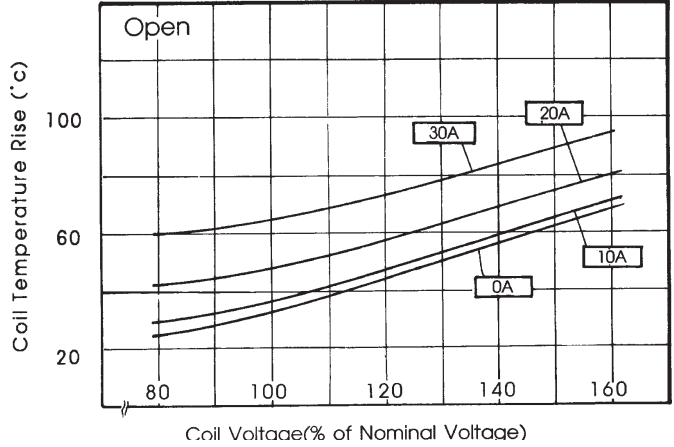
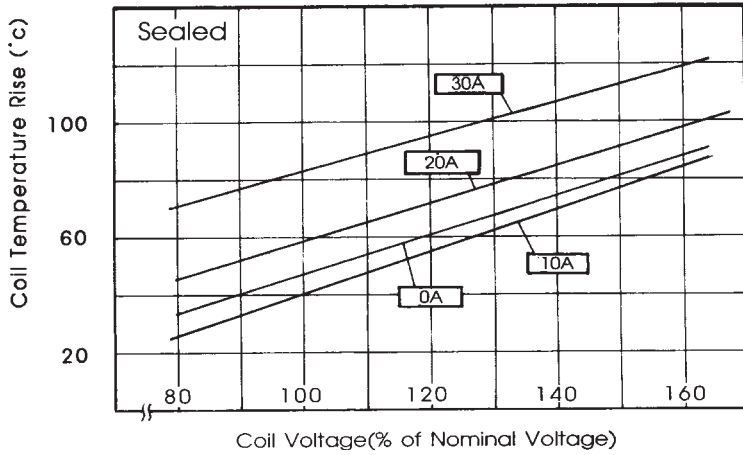

G901/G902 types

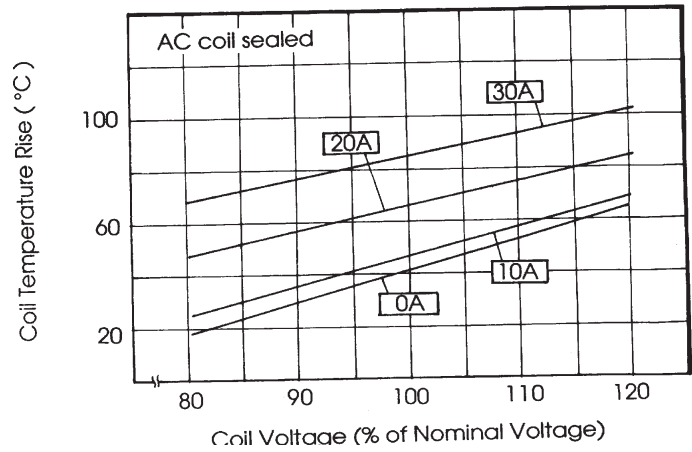
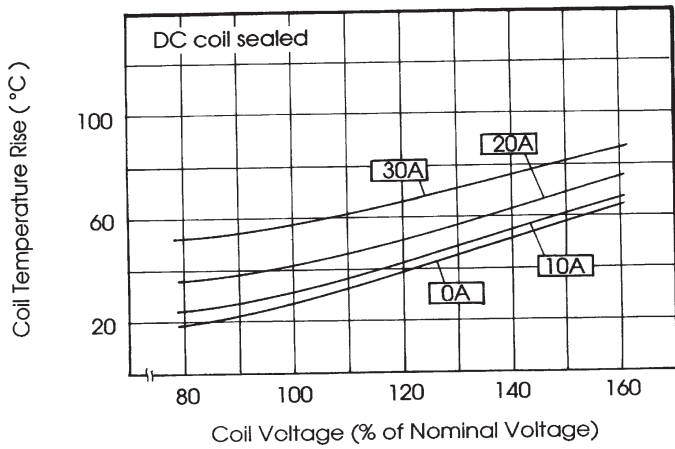

■ **Dimensions**

G90 Style

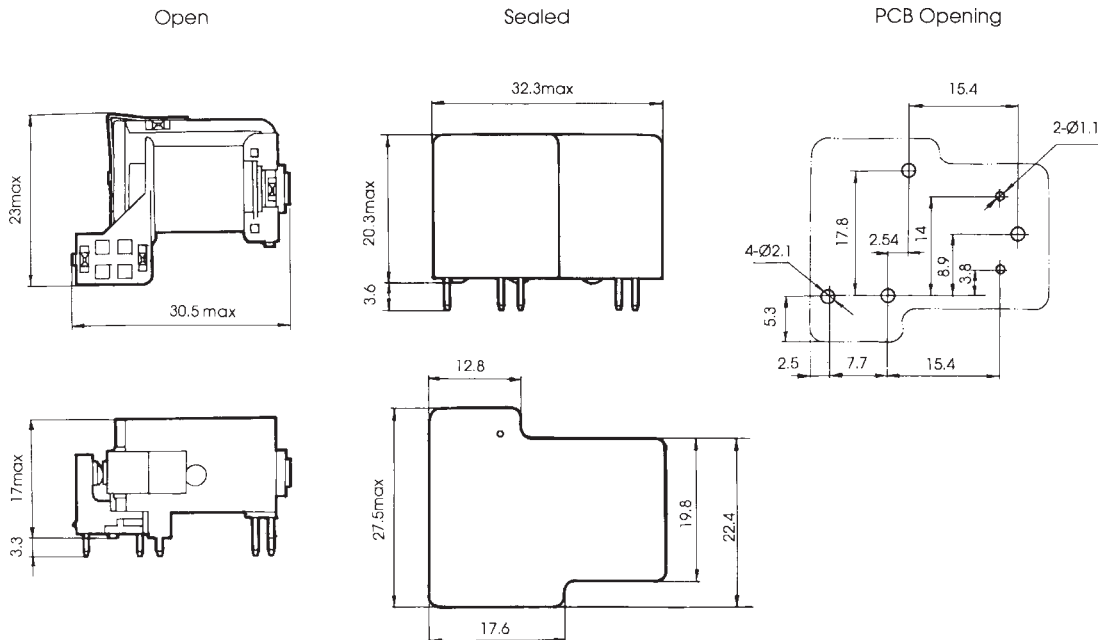

■ Dimensions

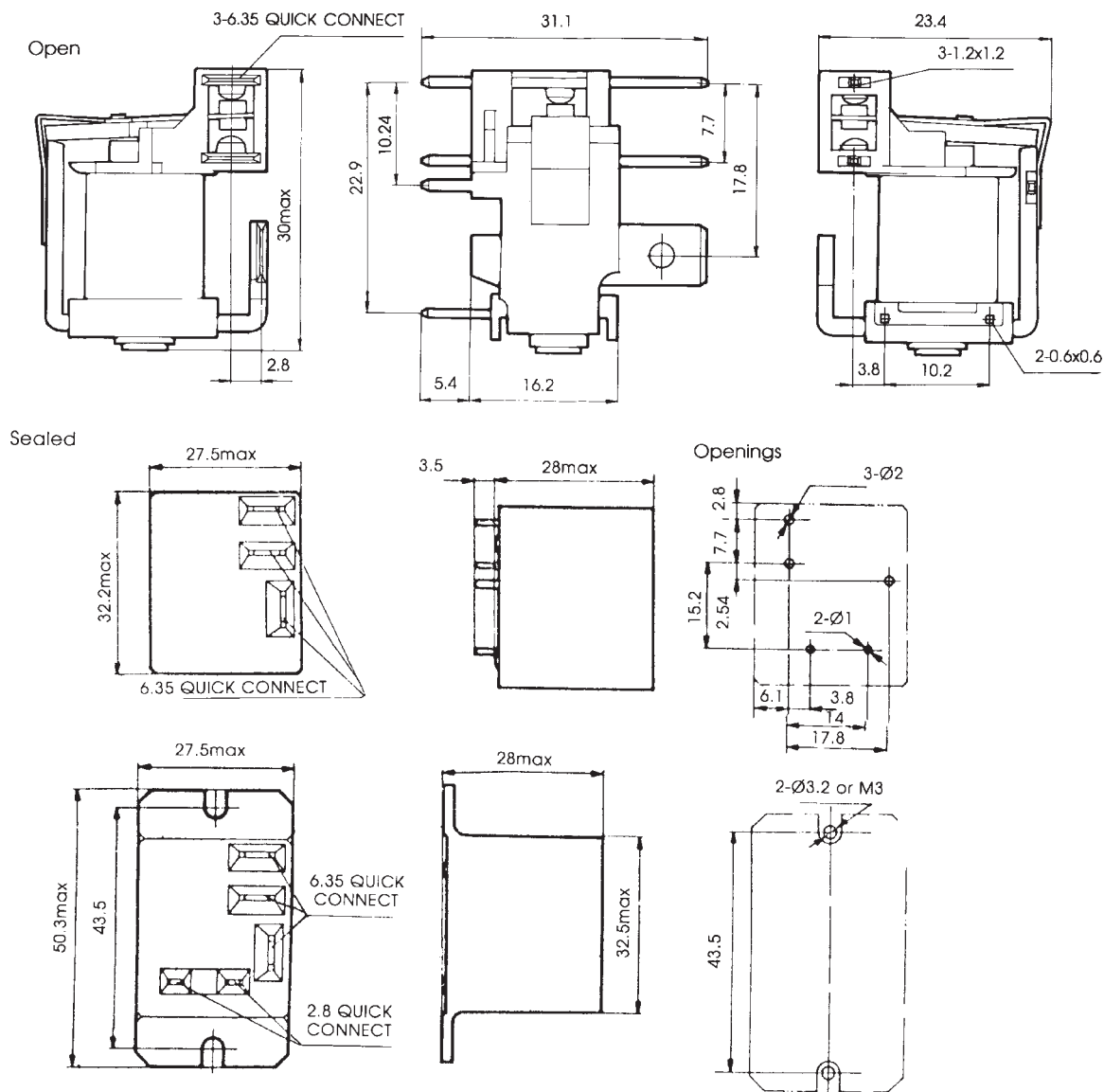

■ Wiring Diagrams

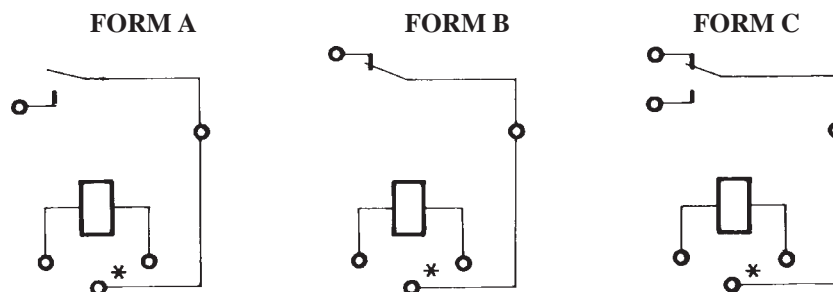

* This terminal is not present for UL873 versions (-1).

Notes:

1. All values, unless otherwise specified, are measured at ambient temperature of 23 °C.
2. Standard contact material is AgCdO. Other materials for special applications are available upon request.
3. For maximum service life, remove tape before putting relays into service after cleaning process.
4. Other UL/CSA ratings available upon request.