

G9015

PNP EPITAXIAL PLANAR TRANSISTOR

Description

The G9015 is designed for use in pre-amplifier of low level and low noise.

Package Dimensions

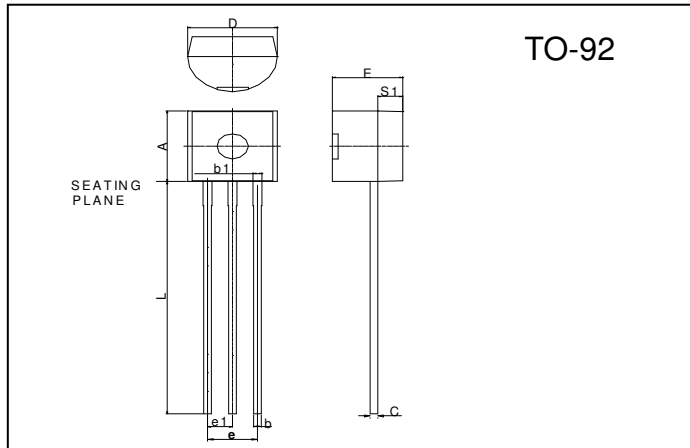

Marking :

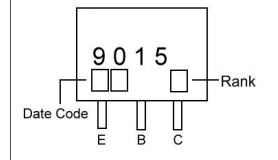

REF.	Millimeter		REF.	Millimeter	
	Min.	Max.		Min.	Max.
A	4.45	4.7	D	4.44	4.7
S1	1.02	-	E	3.30	3.81
b	0.36	0.51	L	12.70	-
b1	0.36	0.76	e1	1.150	1.390
C	0.36	0.51	e	2.42	2.66

Absolute Maximum Ratings at Ta = 25°C

Parameter	Symbol	Ratings	Unit
Junction Temperature	Tj	+150	°C
Storage Temperature	Tstg	-55 ~ +150	°C
Collector to Base Voltage	VCBO	-50	V
Collector to Emitter Voltage	VCEO	-45	V
Emitter to Base Voltage	VEBO	-5	V
Collector Current	IC	-100	mA
Total Power Dissipation	PD	450	mW

Characteristics at Ta = 25°C

Symbol	Min.	Typ.	Max.	Unit	Test Conditions
BVCBO	-50	-	-	V	IC=-100uA, IE=0
BVCEO	-45	-	-	V	IC=-1mA, IB=0
BVEBO	-5	-	-	V	IE=-100uA, IC=0
ICBO	-	-	-50	nA	VCB=-50V, IE=0
IEBO	-	-	-50	nA	VEB=-5V, IC=0
*VCE(sat)	-	-0.20	-0.7	V	IC=-100mA, IB=-5mA
*VBE(sat)	-	-0.82	-1.0	V	IC=-100mA, IB=-5mA
VBE(on)	-0.6	-0.65	-0.75	V	VCE=-5V, IC=-2mA
*hFE	100	200	600		VCE=-5V, IC=-1mA
fT	100	190	-	MHz	VCE=-5V, IC=-10mA
Cob	-	4.5	7	pF	VCB=-10V, f=1MHz

*Pulse Test: Pulse Width≤380us, Duty Cycle≤2%

Classification Of hFE

Rank	B	C
hFE	100 - 300	200 - 600

Characteristics Curve

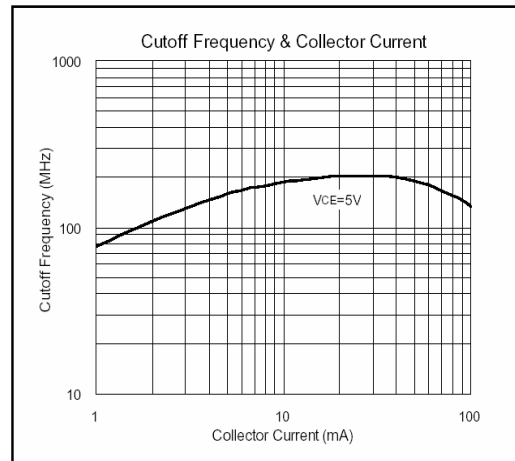
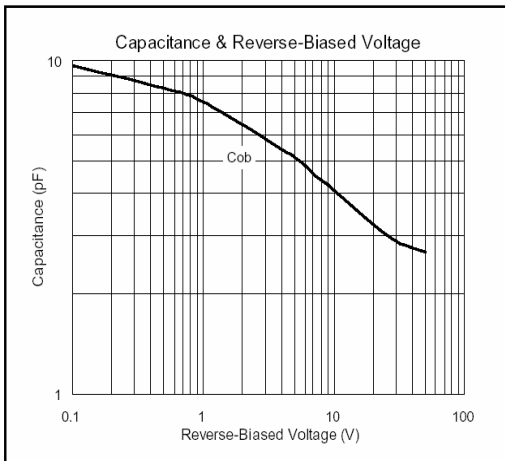
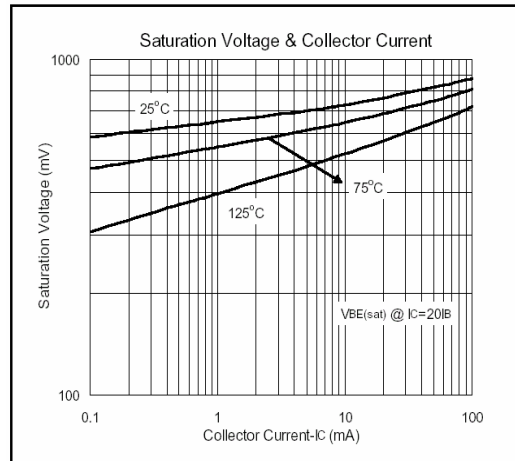
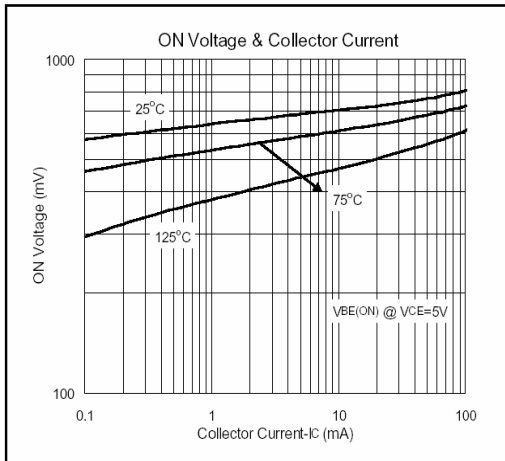
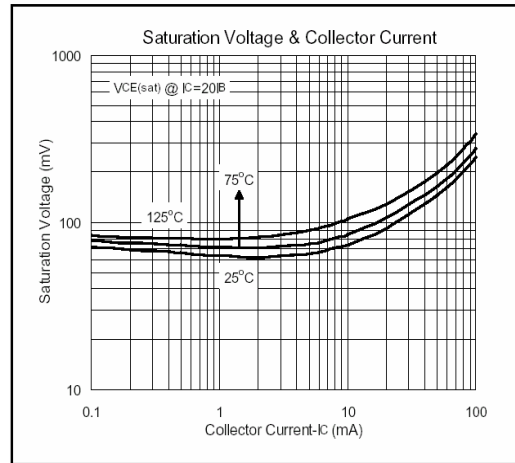
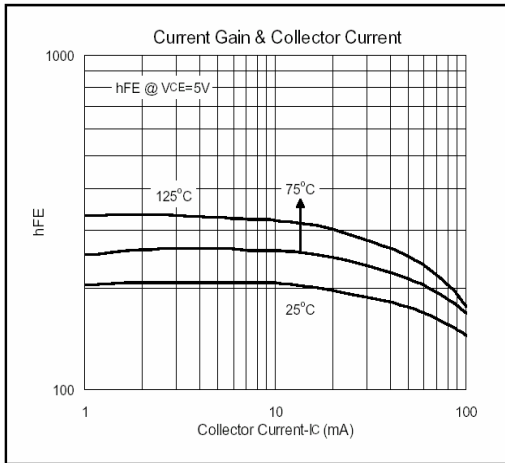

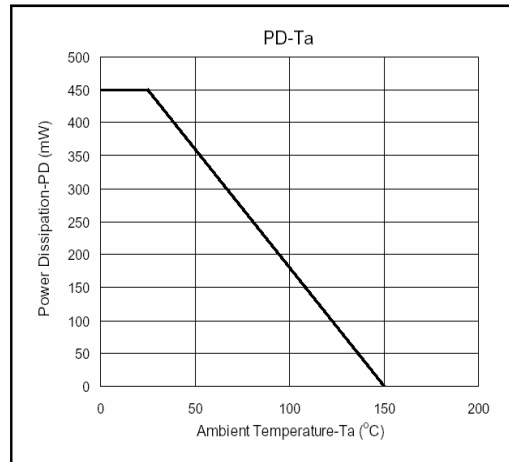
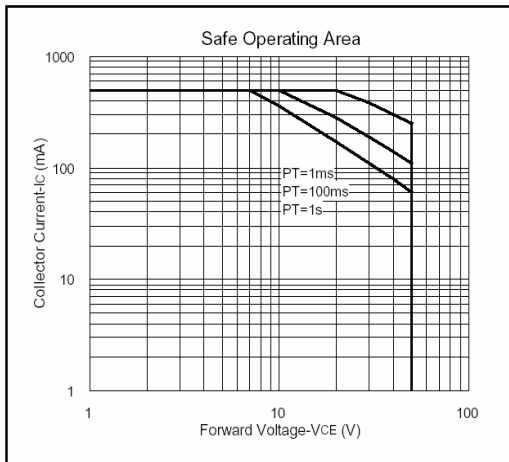

Important Notice:

- All rights are reserved. Reproduction in whole or in part is prohibited without the prior written approval of GTM.
- GTM reserves the right to make changes to its products without notice.
- GTM semiconductor products are not warranted to be suitable for use in life-support Applications, or systems.
- GTM assumes no liability for any consequence of customer product design, infringement of patents, or application assistance.

Head Office And Factory:

- **Taiwan:** No. 17-1 Tatung Rd. Fu Kou Hsin-Chu Industrial Park, Hsin-Chu, Taiwan, R. O. C.
- TEL : 886-3-597-7061 FAX : 886-3-597-9220, 597-0785
- **China:** (201203) No.255, Jang-Jiang Tsai-Lueng RD. , Pu-Dung-Hsin District, Shang-Hai City, China
- TEL : 86-21-5895-7671 ~ 4 FAX : 86-21-38950165